

Installation Instructions

Original Instructions



Allen-Bradley

by ROCKWELL AUTOMATION

FLEX I/O AC Digital Output Modules

Catalog Numbers 1794-0A8, 1794-0A8I, 1794-0A16, 1794-0A16K

Topic	Page
Summary of Changes	1
Environment and Enclosure	3
Preventing Electrostatic Discharge	3
North American Hazardous Location Approval	4
FLEX I/O AC Digital Output Module Overview	4
Install Your Module	5
Wire Your Module	5
Configure the FLEX I/O AC Output Module	9
Specifications	9

Summary of Changes

This publication contains the following new or updated information. This list includes substantive updates only and is not intended to reflect all changes.

Topic	Page
Updated template	throughout
Added new K catalog 1794-0A16K	throughout
Removed discontinued catalog 1794-0A8K	throughout
Updated certifications	12



ATTENTION: Read this document and the documents listed in the Additional Resources section about installation, configuration and operation of this equipment before you install, configure, operate or maintain this product. Users are required to familiarize themselves with installation and wiring instructions in addition to requirements of all applicable codes, laws, and standards.

Activities including installation, adjustments, putting into service, use, assembly, disassembly, and maintenance are required to be carried out by suitably trained personnel in accordance with applicable code of practice. If this equipment is used in a manner not specified by the manufacturer, the protection provided by the equipment may be impaired.

注意：在安装、配置、操作和维护本产品前，请阅读本文档以及“其他资源”部分列出的有关设备安装、配置和操作的相应文档。除了所有适用规范、法律和标准的相关要求之外，用户还必须熟悉安装和接线说明。

安装、调整、投运、使用、组装、拆卸和维护等各项操作必须由经过适当训练的专业人员按照适用的操作规范实施。

如果未按照制造商指定的方式使用该设备，则可能会损害设备提供的保护。

ATENCIÓN: Antes de instalar, configurar, poner en funcionamiento o realizar el mantenimiento de este producto, lea este documento y los documentos listados en la sección Recursos adicionales acerca de la instalación, configuración y operación de este equipo. Los usuarios deben familiarizarse con las instrucciones de instalación y cableado y con los requisitos de todos los códigos, leyes y estándares vigentes. El personal debidamente capacitado debe realizar las actividades relacionadas a la instalación, ajustes, puesta en servicio, uso, ensamblaje, desensamblaje y mantenimiento de conformidad con el código de práctica aplicable. Si este equipo se usa de una manera no especificada por el fabricante, la protección provista por el equipo puede resultar afectada.

ATENÇÃO: Leia este e os demais documentos sobre instalação, configuração e operação do equipamento que estão na seção Recursos adicionais antes de instalar, configurar, operar ou manter este produto. Os usuários devem se familiarizar com as instruções de instalação e fiação além das especificações para todos os códigos, leis e normas aplicáveis.

É necessário que as atividades, incluindo instalação, ajustes, colocação em serviço, utilização, montagem, desmontagem e manutenção sejam realizadas por pessoal qualificado e especializado, de acordo com o código de prática aplicável.

Caso este equipamento seja utilizado de maneira não estabelecida pelo fabricante, a proteção fornecida pelo equipamento pode ficar prejudicada.

ВНИМАНИЕ: Перед тем как устанавливать, настраивать, эксплуатировать или обслуживать данное оборудование, прочитайте этот документ и документы, перечисленные в разделе «Дополнительные ресурсы». В этих документах изложены сведения об установке, настройке и эксплуатации данного оборудования. Пользователи обязаны ознакомиться с инструкциями по установке и прокладке соединений, а также с требованиями всех применимых норм, законов и стандартов.

Все действия, включая установку, наладку, ввод в эксплуатацию, использование, сборку, разборку и техническое обслуживание, должны выполняться обученным персоналом в соответствии с применимыми нормами и правилами.

Если оборудование используется не предусмотренным производителем образом, защита оборудования может быть нарушена.

Если оборудование устанавливается не предусмотренным производителем образом, защита оборудования может быть нарушена. Если оборудование используется не предусмотренным производителем образом, защита оборудования может быть нарушена.

設置調整、運転の開始、使用、組立て、解体、保守を含む諸作業は、該当する実施規則に従って訓練を受けた適切な作業員が実行する必要があります。

本機器が製造メーカーにより指定されていない方法で使用されている場合、機器により提供されている保護が損なわれる恐れがあります。

ACHTUNG: Lesen Sie dieses Dokument und die im Abschnitt „Weitere Informationen“ aufgeführten Dokumente, die Informationen zu Installation, Konfiguration und Bedienung dieses Produkts enthalten, bevor Sie dieses Produkt installieren, konfigurieren, bedienen oder warten. Anwender müssen sich neben den Bestimmungen aller anwendbaren Vorschriften, Gesetze und Normen zusätzlich mit den Installations- und Verdrahtungsanweisungen vertraut machen.

Arbeiten im Rahmen der Installation, Anpassung, Inbetriebnahme, Verwendung, Montage, Demontage oder Instandhaltung dürfen nur durch ausreichend geschulte Mitarbeiter und in Übereinstimmung mit den anwendbaren Ausführungsvorschriften vorgenommen werden.

Wenn das Gerät in einer Weise verwendet wird, die vom Hersteller nicht vorgesehen ist, kann die Schutzfunktion beeinträchtigt sein.

ATTENTION : Lisez ce document et les documents listés dans la section Ressources complémentaires relatifs à l'installation, la configuration et le fonctionnement de cet équipement avant d'installer, configurer, utiliser ou entretenir ce produit. Les utilisateurs doivent se familiariser avec les instructions d'installation et de câblage en plus des exigences relatives aux codes, lois et normes en vigueur.

Les activités relatives à l'installation, le réglage, la mise en service, l'utilisation, l'assemblage, le démontage et l'entretien doivent être réalisées par des personnes formées selon le code de pratique en vigueur.

Si cet équipement est utilisé d'une façon qui n'a pas été définie par le fabricant, la protection fournie par l'équipement peut être compromise.

주의: 본 제품 설치, 설정, 작동 또는 유지 보수하기 전에 본 문서를 포함하여 설치, 설정 및 작동에 관한 참고 자료 섹션의 문서들을 반드시 읽고 숙지하십시오. 사용자는 모든 관련 규정, 법규 및 표준에서 요구하는 사항에 대해 반드시 설치 및 배선 지침을 숙지해야 합니다.

설치, 조정, 작동, 사용, 조립, 분해, 유지보수 등 모든 작업은 관련 규정에 따라 적절한 교육을 받은 사용자를 통해서만 수행해야 합니다.

본 장비를 제조사가 명시하지 않은 방법으로 사용하면 장비의 보호 기능이 손상될 수 있습니다.

ATTENZIONE Prima di installare, configurare ed utilizzare il prodotto, o effettuare interventi di manutenzione su di esso, leggere il presente documento ed i documenti elencati nella sezione "Altre risorse", riguardanti l'installazione, la configurazione ed il funzionamento dell'apparecchiatura. Gli utenti devono leggere e comprendere le istruzioni di installazione e cablaggio, oltre ai requisiti previsti dalle leggi, codici e standard applicabili.

Le attività come installazione, regolazioni, utilizzo, assemblaggio, disassemblaggio e manutenzione devono essere svolte da personale adeguatamente addestrato, nel rispetto delle procedure previste.

Qualora l'apparecchio venga utilizzato con modalità diverse da quanto previsto dal produttore, la sua funzione di protezione potrebbe venire compromessa.

DIKKAT: Bu ürünün kurulumu, yapilandırılması, işletilmesi veya bakımı öncesinde bu dokümanı ve bu ekipmanın kurulumu, yapilandırılması ve işletimi ile ilgili ilave Kaynaklar bölümünde yer listelenmiş dokümanları okuyun. Kullanıcılar yürürlükteki tüm yönetmelikler, yasalar ve standartların gereksinimlerine ek olarak kurulum ve kablolu talimatlarını da öğrenmek zorundadır.

Kurulum, ayarlama, hizmete alma, kullanma, parçaları birleştirme, parçaları sökme ve bakım gibi aktiviteler sadece uygun eğitimleri almış kişiler tarafından yürürlükteki uygulama yönetmeliklerine uygun şekilde yapılabilir.

Bu ekipman üretici tarafından belirlenmiş amacın dışında kullanılırsa, ekipman tarafından sağlanan koruma bozulabilir.

注意事項：在安装、設定、操作或維護本產品前，請先閱讀此文件以及列於「其他資源」章節中有關安裝、設定與操作此設備的文件。使用者必須熟悉安裝和配線指示，並符合所有法規、法律和標準要求。

包括安裝、調整、交付使用、使用、組裝、拆卸和維護等動作都必須交由已經過適當訓練的人員進行，以符合適用的實作法規。

如果將設備用於非製造商指定的用途時，可能會造成設備所提供的保護功能受損。

POZOR: Než začnete instalovat, konfigurovat či provozovat tento výrobek nebo provádět jeho údržbu, přečtěte si tento dokument a dokumenty uvedené v části Dodatečné zdroje ohledně instalace, konfigurace a provozu tohoto zařízení. Uživatelé se musejí vedle požadavků všech relevantních vyhlášek, zákonů a norem nutně seznámit také s pokyny pro instalaci a elektrické zapojení.

Činnosti zahrnující instalaci, nastavení, uvedení do provozu, užívání, montáž, demontáž a údržbu musí vykonávat vhodně proškolený personál v souladu s příslušnými prováděcími předpisy.

Pokud se toto zařízení používá způsobem neodpovídajícím specifikaci výrobce, může být narušena ochrana, kterou toto zařízení poskytuje.

UWAGA: Przed instalacją, konfiguracją, użytkowaniem lub konserwacją tego produktu należy przeczytać niniejszy dokument oraz wszystkie dokumenty wymienione w sekcji Dodatkowe źródła omawiające instalację, konfigurację i procedury użytkowania tego urządzenia. Użytkownicy mają obowiązek zapoznać się z instrukcjami dotyczącymi instalacji oraz oprzewodowania, jak również z obowiązującymi kodeksami, prawem i normami.

Działania obejmujące instalację, regulację, przekazanie do użytkowania, użytkowanie, montaż, demontaż oraz konserwację muszą być wykonywane przez odpowiednio przeszkolony personel zgodnie z obowiązującym kodeksem postępowania.

Jeśli urządzenie jest użytkowane w sposób inny niż określony przez producenta, zabezpieczenie zapewniane przez urządzenie może zostać ograniczone.

Obs! Läs detta dokument samt dokumentet, som står listat i avsnittet Övriga resurser, om installation, konfigurering och drift av denna utrustning innan du installerar, konfigurerar eller börjar använda eller utföra underhållsarbete på produkten. Användare måste bekanta sig med instruktioner för installation och kabeldragning, förutom krav enligt gällande koder, lagar och standarder.

Åtgärder som installation, justering, service, användning, montering, demontering och underhållsarbete måste utföras av personal med lämplig utbildning enligt lämpligt bruk.

Om denna utrustning används på ett sätt som inte anges av tillverkaren kan det hända att utrustningens skyddsanordningar försätts ur funktion.

LET OP: Lees dit document en de documenten die genoemd worden in de paragraaf Aanvullende informatie over de installatie, configuratie en bediening van deze apparatuur voordat u dit product installeert, configureert, bedient of onderhoudt. Gebruikers moeten zich vertrouwd maken met de installatie en de bedringsinstructies, naast de vereisten van alle toepasselijke regels, wetten en normen.

Activiteiten zoals het installeren, afstellen, in gebruik stellen, gebruiken, monteren, demonteren en het uitvoeren van onderhoud mogen uitsluitend worden uitgevoerd door hiervoor opgeleid personeel en in overeenstemming met de geldende praktijkregels.

Indien de apparatuur wordt gebruikt op een wijze die niet is gespecificeerd door de fabrikant, dan bestaat het gevaar dat de beveiliging van de apparatuur niet goed werkt.

Environment and Enclosure



ATTENTION: This equipment is intended for use in a Pollution Degree 2 industrial environment, in overvoltage Category II applications (as defined in EN/IEC 60664-1), at altitudes up to 2000 m (6562 ft) without derating. This equipment is not intended for use in residential environments and may not provide adequate protection to radio communication services in such environments.

This equipment is supplied as open-type equipment for indoor use. It must be mounted within an enclosure that is suitably designed for those specific environmental conditions that will be present and appropriately designed to prevent personal injury resulting from accessibility to live parts. The enclosure must have suitable flame-retardant properties to prevent or minimize the spread of flame, complying with a flame spread rating of 5VA or be approved for the application if nonmetallic. The interior of the enclosure must be accessible only by the use of a tool. Subsequent sections of this publication may contain more information regarding specific enclosure type ratings that are required to comply with certain product safety certifications. In addition to this publication, see the following:

- Industrial Automation Wiring and Grounding Guidelines, publication [1770-4.1](#), for more installation requirements.
- NEMA Standard 250 and EN/IEC 60529, as applicable, for explanations of the degrees of protection provided by enclosures.

Preventing Electrostatic Discharge



ATTENTION: This equipment is sensitive to electrostatic discharge, which can cause internal damage and affect normal operation. Follow these guidelines when you handle this equipment:

- Touch a grounded object to discharge potential static.
- Wear an approved grounding wriststrap.
- Do not touch connectors or pins on component boards.
- Do not touch circuit components inside the equipment.
- Use a static-safe workstation, if available.
- Store the equipment in appropriate static-safe packaging when not in use.



ATTENTION: This product is grounded through the DIN rail to chassis ground. Use zinc-plated chromate-passivated steel DIN rail to assure proper grounding. The use of other DIN rail materials (for example, aluminum or plastic) that can corrode, oxidize, or are poor conductors, can result in improper or intermittent grounding. Secure DIN rail to mounting surface approximately every 200 mm (7.8 in.) and use end-anchors appropriately. Be sure to ground the DIN rail properly.

See the Industrial Automation Wiring and Grounding Guidelines, Rockwell Automation publication [1770-4.1](#), for more information



ATTENTION: If this equipment is used in a manner not specified by the manufacturer, the protection provided by the equipment may be impaired.

Special Conditions for Safe Use



ATTENTION:

- If this equipment is used in a manner not specified by the manufacturer, the protection provided by the equipment may be impaired.
- Read this document and the documents listed in the Additional Resources section about installation, configuration, and operation of this equipment before you install, configure, operate, or maintain this product. Users are required to familiarize themselves with installation and wiring instructions in addition to requirements of all applicable codes, laws, and standards.
- Installation, adjustments, putting into service, use, assembly, disassembly, and maintenance are required to be carried out by suitably trained personnel in accordance with applicable code of practice.
In case of malfunction or damage, no attempts at repair should be made. The module should be returned to the manufacturer for repair.
Do not dismantle the module.
- Use only a soft dry anti-static cloth to wipe down equipment. Do not use any cleaning agents.



WARNING: When you insert or remove the module while backplane power is on, an electric arc can occur. This could cause an explosion in hazardous location installations.



Be sure that power is removed or the area is nonhazardous before proceeding. Repeated electric arcing causes excessive wear to contacts on both the module and its mating connector. Worn contacts may create electrical resistance that can affect module operation.



WARNING: If you insert or remove the module while backplane power is on, an electric arc can occur. This could cause an explosion in hazardous location installations.

Be sure that power is removed or the area is nonhazardous before proceeding.

North American Hazardous Location Approval

The Following Information Applies When Operating This Equipment In Hazardous Locations.	Informations sur l'utilisation de cet équipement en environnements dangereux.
<p>Products marked "CL I, DIV 2, GP A, B, C, D" are suitable for use in Class I Division 2 Groups A, B, C, D, Hazardous Locations and nonhazardous locations only. Each product is supplied with markings on the rating nameplate indicating the hazardous location temperature code. When combining products within a system, the most adverse temperature code (lowest "T" number) may be used to help determine the overall temperature code of the system. Combinations of equipment in your system are subject to investigation by the local Authority Having Jurisdiction at the time of installation.</p>	<p>Les produits marqués "CL I, DIV 2, GP A, B, C, D" ne conviennent qu'à une utilisation en environnements de Classe I Division 2 Groupes A, B, C, D dangereux et non dangereux. Chaque produit est livré avec des marquages sur sa plaque d'identification qui indiquent le code de température pour les environnements dangereux. Lorsque plusieurs produits sont combinés dans un système, le code de température le plus défavorable (code de température le plus faible) peut être utilisé pour déterminer le code de température global du système. Les combinaisons d'équipements dans le système sont sujettes à inspection par les autorités locales qualifiées au moment de l'installation.</p>
<div style="display: flex; align-items: center;">  <div> <p>WARNING: Explosion Hazard -</p> <ul style="list-style-type: none"> • Do not disconnect equipment unless power has been removed or the area is known to be nonhazardous. • Do not disconnect connections to this equipment unless power has been removed or the area is known to be nonhazardous. Secure any external connections that mate to this equipment by using screws, sliding latches, threaded connectors, or other means provided with this product. • Substitution of components may impair suitability for Class I, Division 2. </div> </div>	<div style="display: flex; align-items: center;">  <div> <p>AVERTISSEMENT: Risque d'Explosion -</p> <ul style="list-style-type: none"> • Couper le courant ou s'assurer que l'environnement est classé non dangereux avant de débrancher l'équipement. • Couper le courant ou s'assurer que l'environnement est classé non dangereux avant de débrancher les connecteurs. Fixer tous les connecteurs externes reliés à cet équipement à l'aide de vis, loquets coulissants, connecteurs filetés ou autres moyens fournis avec ce produit. • La substitution de composants peut rendre cet équipement inadapté à une utilisation en environnement de Classe I, Division 2. </div> </div>

FLEX I/O AC Digital Output Module Overview

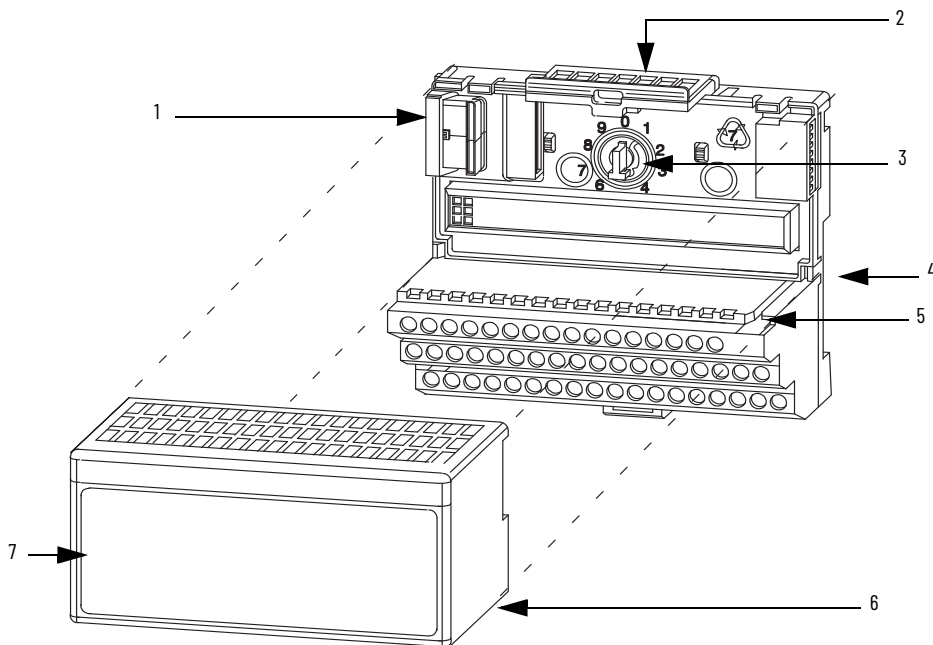

	Description		Description
1	Flexbus connector	5	Groove
2	Latching mechanism	6	Alignment bar
3	Keyswitch	7	Module
4	Terminal base		

Install Your Module

The FLEX™ I/O AC digital output module mounts on a 1794 terminal base.



WARNING: 1794-TBNF and 1794-TBNFK are not approved for Class 1 Division 2 Applications.

1. Rotate the keyswitch (3) on the terminal base (4) clockwise to position 8 as required for this type of module.
2. Make sure the Flexbus connector (1) is pushed all the way to the left to connect with the neighboring terminal base/adaptor.
You cannot install the module unless the connector is fully extended.
3. Make sure the pins on the bottom of the module are straight so they align properly with the connector in the terminal base.
4. Position the module (7) with its alignment bar (6) aligned with the groove (5) on the terminal base.
5. Press firmly and evenly to seat the module in the terminal base. The module is seated when the latching mechanism (2) is locked into the module.

Wire Your Module

Connect Wiring for the 1794-OA8

1. Connect wiring to the different terminal bases as follows:

For 1794-TB2, 1794-TB3, or 1794-TB3S – Connect individual output wiring to even-numbered terminals on the 0...15 row (A) as indicated in the [Wiring Connections for 1794-OA8](#) table.

For 1794-TBN or 1794-TBNF – Connect individual output wiring to even-numbered terminals on the 16...33 row (B) as indicated in the [Wiring Connections for 1794-OA8](#) table.

For 1794-TB2, 1794-TB3, or 1794-TB3S – Connect the associated V AC common (L2) lead of the output device to the corresponding odd-numbered terminal on the 0...15 row (A) for each output as indicated in the [Wiring Connections for 1794-OA8](#) table; or to the corresponding terminal on the 16...33 row (B). The V AC common (L2) terminals of row (B) and the odd-numbered terminals of row (A) are internally connected together.

For 1794-TBN or 1794-TBNF – Connect the associated V AC common (L2) lead of the output device to the corresponding odd-numbered terminal on the 34...51 row (C) for each output as indicated in the [Wiring Connections for 1794-OA8](#) table. The odd-numbered terminals of row (C) are internally connected together to V AC L2 common.

2. Connect V AC power L1 to terminal 34 on the 34...51 row (C).
3. Connect V AC common L2 to terminal 16 on the 16...33 row (B).
4. If daisy chaining V AC power (L1) to the next terminal base, connect a jumper from terminal 51 (V AC L1) on this terminal base to terminal 34 on the next terminal base.
5. If continuing V AC common (L2) to the next terminal base, connect a jumper from terminal 33 (V common L2) on this terminal base to terminal 16 on the next terminal base.

IMPORTANT Total current draw through terminal base connection is limited to 10 A. Separate power connections to each terminal base may be necessary.



ATTENTION: If multiple power sources are used for 1794-OA8I, do not exceed the specified isolation voltage.

Wiring Connections for 1794-OA8

Output ⁽¹⁾	1794-TB2, 1794-TB3, 1794-TB3S		1794-TBN, 1794-TBNF	
	Output Terminal	Common Terminal (L2) ⁽¹⁾	Output Terminal	Common Terminal (L2) ⁽²⁾
0	A-0	A-1/B-17	B-0	C-1
1	A-2	A-3/B-19	B-2	C-3
2	A-4	A-5/B-21	B-4	C-5
3	A-6	A-7/B-23	B-6	C-7
4	A-8	A-9/B-25	B-8	C-9
5	A-10	A-11/B-27	B-10	C-11

Wiring Connections for 1794-0A8 (Continued)

	1794-TB2, 1794-TB3, 1794-TB3S		1794-TBN, 1794-TBNF	
Output ⁽¹⁾	Output Terminal	Common Terminal (L2) ⁽¹⁾	Output Terminal	Common Terminal (L2) ⁽²⁾
6	A-12	A-13/B-29	B-12	C-13
7	A-14	A-15/B-31	B-14	C-15

A = Output terminals (Even-numbered terminals 0...14)
 B = Common terminals
 C = Power terminals (C-34 and C-51 on 1794-TB2; C-34...C-51 on 1794-TB3 and 1794-TB3S)

B = Even-numbered output terminals 0...14, AC common terminals 16 and 33
 C = Power terminals C-34 and C-51, and odd-numbered output terminals 1...15

(1) A-1, 3, 5, 7, 9, 11, 13, and 15 on the 1794-TB2, 1794-TB3, and 1794-TB3S are internally connected in the module to 120V AC common (L2).

(2) C-1, 3, 5, 7, 9, 11, 13, and 15 on the 1794-TBN and 1794-TBNF are internally connected in the module to 120V AC common (L2).

1794-TB2, 1794-TB3, and 1794-TB3S Terminal Base Wiring for 1794-0A8

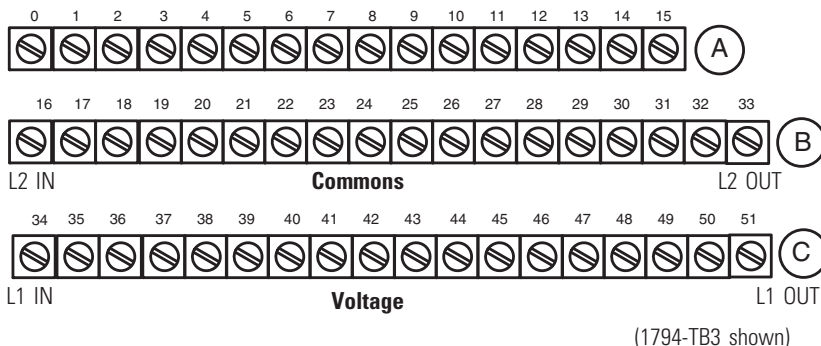

Connect 120V AC common L2 to terminal B-16.
 Connect 120V AC power L1 to terminal C-34.
 (Use B-33 and C-51 for daisy-chaining power to the next terminal base unit.)
 (Terminals C-35...C-50 are not present on the 1794-TB2.)

1794-TBN and 1794-TBNF Terminal Base Wiring for 1794-0A8

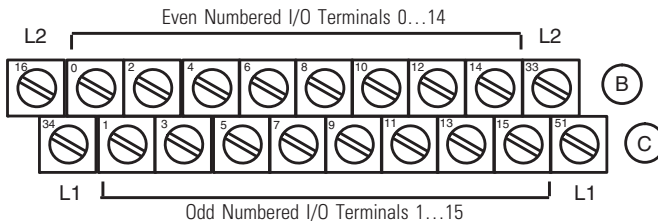

Connect 120V AC (L2) to terminal B-16
 Connect 120V AC power (L1) to terminal C-34
 Use B-33 and C-51 for daisy-chaining to the next terminal base

Connect Wiring for the 1794-0A8I

1. Connect wiring to the different terminal bases as follows:

For 1794-TB2, 1794-TB3, or 1794-TB3S – Connect individual output wiring to the even-numbered terminals on the 0...15 row (A).

For 1794-TBN or 1794-TBNF – Connect individual output wiring to the even-numbered terminals on the 16...33 row (B).

For 1794-TB2, 1794-TB3, or 1794-TB3S – Connect the associated V AC power lead (L1) to the corresponding odd-numbered terminal on the 0...15 row (A) for each output as indicated in the [Wiring Connections for 1794-0A8I](#) table.

For 1794-TBN or 1794-TBNF – Connect the associated VAC power (L1) lead to the odd-numbered terminals on row (C).

IMPORTANT Individual isolated 120V AC common (L2) leads must be run externally to each output device.



WARNING: When used in a Class I, Division 2, hazardous location, this equipment must be mounted in a suitable enclosure with proper wiring method that complies with the governing electrical codes.

Wiring Connections for 1794-0A8I

Output ⁽¹⁾	1794-TB2, 1794-TB3, 1794-TB3S		1794-TBN, 1794-TBNF	
	Output Terminal	120V AC Supply ⁽¹⁾	Output Terminal	120V AC Supply ⁽²⁾
0	A-0	A-1	B-0	C-1
1	A-2	A-3	B-2	C-3
2	A-4	A-5	B-4	C-5
3	A-6	A-7	B-6	C-7
4	A-8	A-9	B-8	C-9
5	A-10	A-11	B-10	C-11
6	A-12	A-13	B-12	C-13
7	A-14	A-15	B-14	C-15

(1) A = Even numbered terminal 0...14 for customer connections; corresponding odd-numbered 120V AC supply L1 terminals 1...15 for customer connections from isolated power supply.
 (2) B = Even-numbered terminal 0...14 for customer connections; C = Odd-numbered 120V AC supply L1 terminals 1...15 for customer connections from isolated power supply.

1794-TB2, 1794-TB3, and 1794-TB3S Terminal Base Wiring for 1794-0A8I

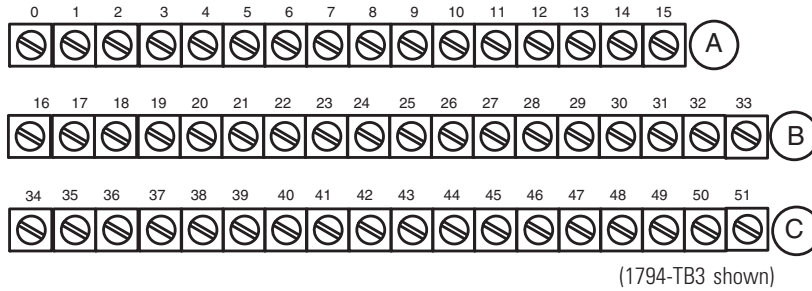

Connect outputs to even numbered terminals on row (A)
 Connect isolated 120V AC (L1) to odd numbered terminals on row (A)
 Individual isolated 120V AC common (L2) must be run externally to each of the output devices
 (Terminals C-35...C-50 are not available on the 1794-TB2.)

1794-TBN and 1794-TBNF Terminal Base Wiring for 1794-0A8I

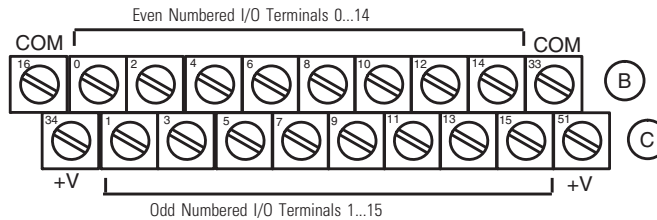

Connect outputs to even numbered terminals on row (B).
 Connect isolated 120V AC (L1) to odd numbered terminals on row (C).
 Individual isolated 120V AC common (L2) must be run externally to each of the output devices.

Connect Wiring for the 1794-0A16 and 1794-0A16K

1. Connect wiring to the different terminal bases as follows:

For 1794-TB2, 1794-TB3, or 1794-TB3S – Connect individual output wiring to numbered terminals on the 0...15 row (A) as indicated in the Wiring Connections for 1794-0A16 table.

For 1794-TBN – Connect individual output wiring to terminals 0...15 on rows B and C.

For 1794-TB2, 1794-TB3, or 1794-TB3S – Connect the associated VAC common (L2) lead of the output device to the corresponding numbered terminal on the 16...33 row (B) for each output as indicated in the [Wiring Connections for 1794-0A16 and 1794-0A16K](#) table. The V AC common terminals of row (B) are internally connected together.

For 1794-TBN – Auxiliary terminal blocks are required to connect the associated L2 common for each channel. Connect the L2 side of the load together and then connect to L2 on the power supply.

2. Connect 120V AC power L1 to terminal 34 on the 34...51 row (C).
3. Connect 120V AC common L2 to terminal 16 on the 16...33 row (B).
4. If daisy chaining power to the next terminal base, connect a jumper from terminal 51 (120V AC L1) on this terminal base to terminal 34 on the next terminal base.
5. If continuing 120V AC common (L2) to the next terminal base, connect a jumper from terminal 33 (120V AC common L2) on this terminal base to terminal 16 on the next terminal base.

IMPORTANT Total current draw through terminal base connection is limited to 10 A. Separate power connections to each terminal base may be necessary.

Wiring Connections for 1794-OA16 and 1794-OA16K

Output Channel	1794-TB2, 1794-TB3, 1794-TB3S		1794-TBN
	Output Terminal	120V AC Common (L2)	Output Terminal ⁽¹⁾
0	A-0	B-17	B-0
1	A-1	B-18	C-1
2	A-2	B-19	B-2
3	A-3	B-20	C-3
4	A-4	B-21	B-4
5	A-5	B-22	C-5
6	A-6	B-23	B-6
7	A-7	B-24	C-7
8	A-8	B-25	B-8
9	A-9	B-26	C-9
10	A-10	B-27	B-10
11	A-11	B-28	C-11
12	A-12	B-29	B-12
13	A-13	B-30	C-13
14	A-14	B-31	B-14
15	A-15	B-32	C-15
120V AC L1 power	Connect V AC L1 to C-34. 1794-TB3, 1794-TB3S – Power terminals C-34...C-51 are internally connected together. 1794-TB2 and 1794-TBN – C-34 and C-51 are internally connected together.		
120V AC L2	Connect 120V AC common L2 to terminal B-16. 1794-TB3, 1794-TB3S – 120V AC common L2 terminals B-16...B-33 are internally connected together. 1794-TB2, 1794-TBN – 120V AC common L2 terminals B-16 and B-33 internally connected together.		

(1) Auxiliary terminal blocks are required to connect the associated L2 common for each channel when using a 1794-TBN terminal base with the 1794-OA16 and 1794-OA16K modules.

1794-TB2, 1794-TB3, and 1794-TB3S Terminal Base Wiring for 1794-OA16 and 1794-OA16K

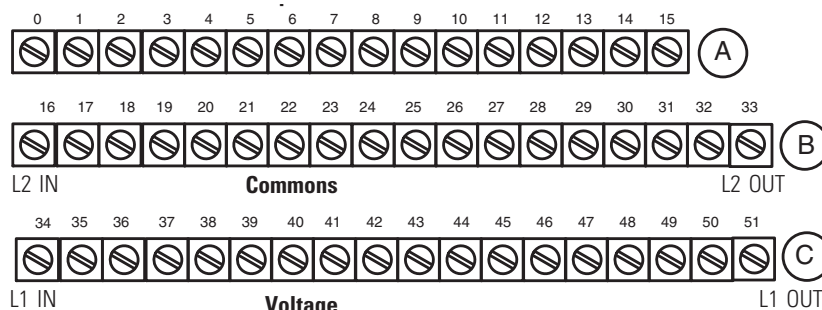

(1794-TB3 shown)

Connect 120V AC common L2 to terminal B-16.
 Connect 120V AC power L1 to terminal C-34.
 (Use B-33 and C-51 for daisy-chaining power to the next terminal base unit.)
 (Terminals C-35...C-50 are not present on the 1794-TB2.)

45675

1794-TBN Terminal Base Wiring for 1794-0A16 and 1794-0A16K

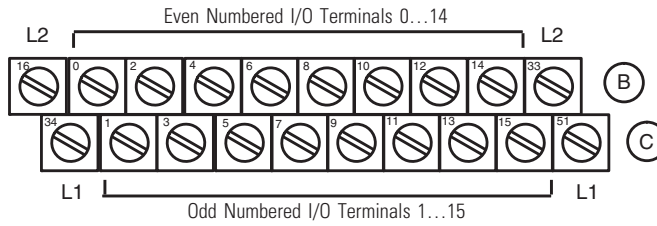

Connect 120V AC (L2) to terminal B-16
 Connect 120V AC power (L1) to terminal C-34
 Use B-33 and C-51 for daisy chaining to the next terminal base
 45676

Configure the FLEX I/O AC Output Module

See [Table 1](#) and [Table 2](#) to configure your FLEX I/O output module.

Table 1 - Image Table Memory Map for the 1794-0A8 and 1794-0A8I Modules

Dec	15	14	13	12	11	10	9	8	7	6	5	4	3	2	1	0
Oct	17	16	15	14	13	12	11	10	7	6	5	4	3	2	1	0
Read	Not used - set to 0															
Write	Not used - set to 0															
Where	0 = Output number															

Table 2 - Image Table Memory Map for the 1794-0A16 and 1794-0A16K Modules

Dec	15	14	13	12	11	10	9	8	7	6	5	4	3	2	1	0
Oct	17	16	15	14	13	12	11	10	7	6	5	4	3	2	1	0
Read	Not used - set to 0															
Write	015	014	013	012	011	010	09	08	07	06	05	04	03	02	01	00
Where	0 = Output number															

Specifications

Specifications - 1794-0A8, 1794-0A8I

Attribute	1794-0A8	1794-0A8I
Number of outputs	8, nonisolated	8, isolated
Recommended terminal base	1794-TBN ⁽¹⁾ , 1794-TBNF, 1794-TB2, 1794-TB3, 1794-TB3S, 1794-TBKD, 1794-TBNK, 1794-TBNFK, 1794-TB3K, 1794-TB3SK	
Output voltage, min	85V AC	
Output voltage, nom	120V AC	
Output voltage, max	132V AC	
Output current rating	4.0 A (8 outputs @ 500 mA)	
On-state current, min	5.0 mA per output	
On-state current, max ⁽²⁾	500 mA per output @ 55 °C (sufficient to operate an Allen-Bradley® Bulletin 500 NEMA size 3 motor starter) 750 mA per output @ 35 °C 1.0 A on 4 non-adjacent outputs, 500 mA on the remaining 4 outputs @ 30 °C	
On-state voltage drop, max	1.0V @ 0.5 A	
Surge current	7 A for 40 ms, repeatable every 8 seconds	
Off-state leakage current, max	2.25 mA	
Isolation voltage	120V (continuous), field to backplane Tested @ 1250V AC for 60 s No isolation between individual channels.	120V (continuous), field to backplane, channel to channel Tested @ 1250V AC for 60 s Isolation between individual channels.
Output signal delays ⁽³⁾	Off to On 1/2 cycle max On to Off 1/2 cycle max	
Flexbus current	80 mA @ 5V DC	

Specifications – 1794-0A8, 1794-0A8I (Continued)

Attribute	1794-0A8	1794-0A8I
Power dissipation, max	4.1 W @ 0.5 A 6.3 W @ 0.75 A 6.3 W @ 1.0 A	
Thermal dissipation, max	14.0 BTU/hr @ 0.5 A 21.2 BTU/hr @ 0.75 A 21.4 BTU/hr @ 1.0 A	
Fusing ⁽⁴⁾	1.6 A, 250V AC slow-blow, Littelfuse 23901.6; San-O SD6-1.6 (1.6 A fuses come installed in 1794-TBNF terminal bases)	

- (1) Auxiliary terminal strips are required when using the 1794-TBN terminal base.
- (2) Below 50 mA the voltage drop across the module will be higher and the voltage waveform may have some small oscillation (less than 5V).
- (3) Output signal delay is the time from receipt of an output on or off command to the output actually turning on or off.
- (4) Module outputs are not fused. Fusing is recommended. If fusing is desired, you must supply external fusing or use the 1794-TBNF terminal base, if recommended.

Specifications – 1794-0A16 and 1794-0A16K

Attribute	Value
Number of outputs	16, nonisolated
Recommended terminal base	1794-TBN ⁽¹⁾ , 1794-TBNF, 1794-TB2, 1794-TB3, 1794-TB3S, 1794-TBKD, 1794-TBNK, 1794-TBNFK, 1794-TB3K, 1794-TB3SK
Mounting	See derating curve
Output voltage range, min	74V AC
Output voltage range, nom	120V AC
Output voltage range, max	132V AC
Output current rating ⁽²⁾	4.0 A (16 outputs @ 250 mA)
On-state current, min	5.0 mA per output
On-state current, max ⁽³⁾	500 mA per output @ 55 °C
On-state voltage drop, max	1.5V @ 0.5 A
Surge current	7 A for 40 ms, repeatable every 8 seconds
Off-state leakage current, max	2.25 mA
Isolation voltage	120V (continuous), field to backplane Tested @ 1250V AC for 60 s No isolation between individual channels.
Output signal delays ⁽⁴⁾	Off to On On to Off
Flexbus current	80 mA @ 5V DC
Power dissipation, max	4.7 W @ 0.5 A
Thermal dissipation, max	16.1 BTU/hr @ 0.5 A
Fusing ⁽⁵⁾	2.5 A, 150V AC normal blow, MQ2

- (1) Auxiliary terminal strips are required when using the 1794-TBN terminal base.
- (2) If using 0.5 A outputs, alternate wiring so that no two 0.5 A outputs are next to each other.
- (3) Below 50 mA the voltage drop across the module will be higher and the voltage waveform may have some small oscillation (less than 5V).
- (4) Output signal delay is the time from receipt of an output on or off command to the output actually turning on or off.
- (5) Module outputs are not fused. Fusing is recommended. If fusing is desired, you must supply external fusing or use the 1794-TBNF terminal base, if recommended.

General Specifications

Attribute	Value
Terminal base screw torque	Determined by installed terminal base
Dimensions, approx. (H x W x D)	94 x 94 x 69 mm (3.7 x 3.7 x 2.7 in.)
Weight, approx.	109 g (3.84 oz.) – 1794-0A8 107 g (3.77 oz.) – 1794-0A8I 96 g (3.38 oz.) – 1794-0A16, 1794-0A16K
Indicators (field side indication)	8 yellow status indicators – 1794-0A8, 1794-0A8I 16 yellow status indicators – 1794-0A16, 1794-0A16K
External AC power supply voltage	120V AC
External AC power voltage range	85...132V AC – 1794-0A8, 1794-0A8I 74...132V AC – 1794-0A16, 1794-0A16K
Keyswitch position	8
Pilot duty rating	5 A Inrush

General Specifications (Continued)

Attribute	Value
North American temp code	T4A - 1794-0A8, 1794-0A8I T4 - 1794-0A16, 1794-0A16K
Enclosure type rating	None (open-style)
Wire size	Determined by installed terminal base
Wiring category ⁽¹⁾	2 - on signal ports

(1) Use this conductor category information for planning conductor routing as described in Industrial Automation Wiring and Grounding Guidelines, publication [1770-4.1](#).

Environmental Specifications

Attribute	Value
Operating temperature	IEC 60068-2-1 (Test Ad, Operating Cold), IEC 60068-2-2 (Test Bd, Operating Dry Heat), IEC 60068-2-14 (Test Nb, Operating Thermal Shock): -20...+55 °C (-4...+131 °F) - 1794-0A8, 1794-0A8I 0 °C < Ta < +55 °C (+32 °F < Ta < +131 °F) - 1794-0A16, 1794-0A16K
Temperature, surrounding air, max	55 °C (131 °F)
Temperature, nonoperating	IEC 60068-2-1 (Test Ab, Unpackaged nonoperating Cold), IEC 60068-2-2 (Test Bb, Unpackaged nonoperating Dry Heat), IEC 60068-2-14 (Test Na, Unpackaged nonoperating Thermal Shock): -40...+85 °C (-40...+185 °F)
Relative humidity	IEC 60068-2-30 (Test Db, Unpackaged Damp Heat): 5...95% noncondensing
Vibration	IEC60068-2-6 (Test Fc, Operating): 5 g @ 10...500 Hz
Shock, operating	IEC60068-2-27 (Test Ea, Unpackaged shock): 30 g
Shock, nonoperating	IEC60068-2-27 (Test Ea, Unpackaged shock): 50 g
Emissions	IEC 61000-6-4
ESD immunity	IEC 61000-4-2: 6 kV contact discharges 8 kV air discharges
Radiated RF immunity	IEC 61000-4-3: 10V/m with 1 kHz sine-wave 80% AM from 80...2000 MHz 10V/m with 200 Hz 50% Pulse 100% AM @ 900 MHz 10V/m with 200 Hz 50% Pulse 100% AM @ 1890 MHz 1V/m with 1 kHz sine-wave 80% AM from 2000...2700 MHz
EFT/B immunity	IEC 61000-4-4: ±2 kV @ 5 kHz on power ports ±2 kV @ 5 kHz on signal ports
Surge transient immunity	IEC 61000-4-5: ±1 kV line-line(DM) and ±2 kV line-earth(CM) on signal ports
Conducted RF immunity	IEC 61000-4-6: 10V rms with 1 kHz sine-wave 80% AM from 150 kHz...80 MHz

Certifications

Certifications (when product is marked) ⁽¹⁾	Value
c-UL-us	<p>For 1794-0A8, 1794-0A81 UL Listed Industrial Control Equipment, certified for US and Canada. See UL File E65584. UL Listed for Class I, Division 2 Group A, B, C, D Hazardous Locations, certified for U.S. and Canada. See UL File E194810.</p> <p>For 1794-0A16, 1794-0A16K UL Listed Industrial Control Equipment, certified for US and Canada. See UL File E322657. UL Listed for Class I, Division 2 Group A, B, C, D Hazardous Locations, certified for U.S. and Canada. See UL File E334470.</p>
CE	European Union 2014/30/EU EMC Directive, compliant with: EN 61326-1; Meas./Control/Lab., Industrial Requirements EN 61000-6-2; Industrial Immunity EN 61000-6-4; Industrial Emissions EN 61131-2; Programmable Controllers (Clause 8, Zone A & B) European Union 2014/35/EU LVD, compliant with: EN 61131-2; Programmable Controllers (Clause 11) European Union 2011/65/EU RoHS, compliant with: EN IEC 63000; Technical Documentation
KC	Korean Registration of Broadcasting and Communications Equipment, compliant with: Article 58-2 of Radio Waves Act, Clause 3
EAC	Russian Customs Union TR CU 020/2011 EMC Technical Regulation Russian Customs Union TR CU 004/2011 LV Technical Regulation
RCM	Australian Radiocommunications Act, compliant with: EN 61000-6-4; Industrial Emissions
Morocco	Arrêté ministériel n° 6404-15 du 1 er muharram 1437 Arrêté ministériel n° 6404-15 du 29 ramadan 1436

(1) See the Product Certification link at rok.auto/certifications for Declarations of Conformity, Certificates, and other certification details.

Derating Curve for 1794-0A16, 1794-0A16K

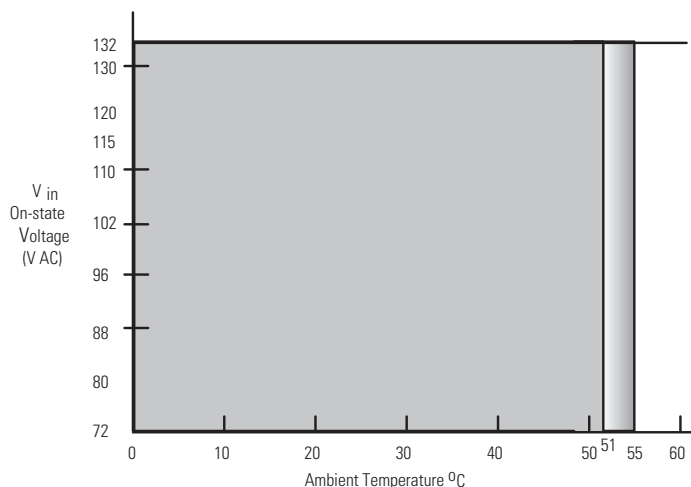

The area within the curve represents the safe operating range for the module under various conditions of user supplied 120V AC supply voltages and ambient temperatures.

= Normal mounting safe operating range. Includes
 = Other mounting positions (including inverted horizontal, vertical) safe operating range

Mounting	Temperature, Max
Normal horizontal	55 °C
Other mounting positions (including inverted horizontal, vertical)	51 °C

Notes:

Rockwell Automation Support

Use these resources to access support information.

Technical Support Center	Find help with how-to videos, FAQs, chat, user forums, and product notification updates.	rok.auto/support
Knowledgebase	Access Knowledgebase articles.	rok.auto/knowledgebase
Local Technical Support Phone Numbers	Locate the telephone number for your country.	rok.auto/phonesupport
Literature Library	Find installation instructions, manuals, brochures, and technical data publications.	rok.auto/literature
Product Compatibility and Download Center (PCDC)	Download firmware, associated files (such as AOP, EDS, and DTM), and access product release notes.	rok.auto/pcdc

Documentation Feedback

Your comments help us serve your documentation needs better. If you have any suggestions on how to improve our content, complete the form at rok.auto/docfeedback.





Waste Electrical and Electronic Equipment (WEEE)



At the end of life, this equipment should be collected separately from any unsorted municipal waste.

Rockwell Automation maintains current product environmental compliance information on its website at rok.auto/pec.

Rockwell Otomasyon Ticaret A.Ş. Kar Plaza İş Merkezi E Blok Kat:6 34752 İçerenköy, İstanbul, Tel: +90 (216) 5698400 EEE Yönetmeliğine Uygundur

Connect with us.    

rockwellautomation.com — expanding **human possibility**[®]

AMERICAS: Rockwell Automation, 1201 South Second Street, Milwaukee, WI 53204-2496 USA, Tel: (1) 414.382.2000, Fax: (1) 414.382.4444

EUROPE/MIDDLE EAST/AFRICA: Rockwell Automation NV, Pegasus Park, De Kleetlaan 12a, 1831 Diegem, Belgium, Tel: (32) 2 663 0600, Fax: (32) 2 663 0640

ASIA PACIFIC: Rockwell Automation, Level 14, Core F, Cyberport 3, 100 Cyberport Road, Hong Kong, Tel: (852) 2887 4788, Fax: (852) 2508 1846

Allen-Bradley, expanding human possibility, FactoryTalk, FLEX, Rockwell Automation, and TechConnect are trademarks of Rockwell Automation, Inc. Trademarks not belonging to Rockwell Automation are property of their respective companies.

Publication 1794-IN103E-EN-P - November 2021 | Supersedes Publication 1794-IN103D-EN-P-July 2018
Copyright © 2021 Rockwell Automation, Inc. All rights reserved.