



Allen-Bradley

Technical Data

1336 PLUS II Adjustable Frequency AC Drive



1336 PLUS II

SENSORLESS VECTOR

**Rockwell
Automation**

A Complete Line of Drives for a Complete Family of Products

Available in ratings from 0.37 to 448 kW (0.5 to 600 horsepower), the drive helps to provide a single solution for virtually all of your speed control requirements. Commonality of design across the entire range, coupled with identical control interface functions, device communications, training and maintenance, provide you with a tremendous advantage in your control needs. Add that to integration with Allen-Bradley SMC™ and SMP™ power products, the 1305 drive, the 1336 IMPACT™ and 1336 FORCE™ field-oriented control drives (all of which use the same control interface and communication options) and you've just gained significant advantage in system design, component integration, operator training and maintenance.



1336 PLUS II Product Data

Product Description	4
Specifications	6
Function Description	11
Fault and Parameter List	18
1336 PLUS II PRE-INSTALLATION	21
IP 20 (NEMA Type 1) Dimensions	22
IP 65/54 (NEMA Type 4/12) Dimensions	28
IP 20 (NEMA Type 1) Bottom View Dimensions	29
Mounting Requirements	31
Input Conditioning	31
AC Supply Source	32
Power Wiring – TB1	36
Control and Signal Wiring	40
General Wiring Information	40
Terminal Block – TB2	41
Terminal Block – TB3	41
Encoder Inputs	45
Pulse Input/Output	46
Digital Outputs	46
Analog Inputs/Outputs	47
Motor Cables	50
User Supplied Enclosures	55
Derating Guidelines	56
1336 PLUS II Remote Device Distances	61
1336 PLUS II SELECTION GUIDE	63
Catalog Number Explanation	63
Constant/Variable Torque Drives and Enclosures	64
Language Groups	65
Dynamic Brake Kits	65
Factory Installed Options	66
Field Installed Options	67
Standard Packaged Drives Program	69-119

Product Description

Features

Protective

- Detection and Trip:
 - Undervoltage*
 - Overtvoltage*
 - Drive Overcurrent*
 - Overtemperature*
 - External Signal*
 - Drive Output Short*
 - Ground Fault*
 - Encoder Loss*
 - At temperature*
 - Load Loss*
 - Single Phase*
- Overcurrent Stall
- Overtvoltage Stall
- Six Drive Alarms
- Fault Reset Input

Special Function

- Auto Economizer
- Process PI Controller
- Traverse Function
- Selectable Fault Reset & Run
- Auto Restart on Power Up
- Speed Sensitive Electronic Overload
- Auto-tuning
- Step Logic

Operational

-  Control
- Selectable Volts/Hertz Mode
- Multi-lingual selection

Programmable

- Dual Accel/Decel Profiles
- Three Skip Frequencies
- DC Injection Braking
- Dynamic Braking
- Slip Compensation
- Negative Slip Compensation (Droop)
- S Curve Accel/Decel Profile
- Line Loss Restart Mode
- Proactive Current Limit
- Last Four Event Fault Memory
- Flying Start
- Seven Preset Speeds

I/O Interface

- Control Output Contacts (2) Form A (N.O.) (2) Form C (N.O. - N.C.) Programmable to 17 different drive variables.
- Flexible Analog Inputs/Outputs
- Pulse Train Input
- Encoder Feedback Closed Loop Speed Control
- High Speed Input

Diagnostics

Real time preventive maintenance coupled with customized status and fault reporting.

Depending upon your particular drive configuration, status and fault conditions can be reported through the Human Interface Module or through the SCANport™ Communications Port. Fault diagnostic routines are started each time the 1336 PLUS II is powered up. Throughout the entire run sequence, the drive will continue to look for potential fault conditions.

To allow real-time preventive maintenance, drive output current and control conditions can be selectively monitored while the drive is running. The operator is made aware of alarm conditions such as current limit, bus voltage status, motor overload or drive overload before the drive reaches a fault level. Should a fault occur, plain language diagnostic messages will help identify and isolate the problem, allowing personnel to take quick, corrective action.

Packaging

Small size conserves expensive panel space.

Planer Construction eliminates most internal cables and connectors. Increases reliability.

Laminar Bus Design reduces internal inductance, thereby reducing snubber losses and improving IGBT performance.

Removable Human Interface provides simplicity of programming and flexibility of operation.

Thermal Dissipation Management. Design and extensive infrared testing minimizes hot spots to maximize reliability.

NEMA and European standards. Designed for acceptability throughout the world.

IP 65 & 54 (NEMA Type 4 & 12) configurations accommodated with "heat sink through the back" design.

Electrical

IGBT's (Insulated Gate Bipolar Transistors)

- Quiet motor operation through programmable carrier frequency.
- Third Generation devices – Reduced switching and conduction losses.
- Used on complete line 0.37-448 kW (0.5-600 HP).

Status LEDs. Four status indicators located on the control board.

Dynamic Current Control

- Multiple sensors.
- Exceptional torque production through  Control.
- Proactive current limit control – Reduces trips.
- Ability to start low inductance motors.

Independent Certification. C-UL Listed for dual U.S. and Canadian Certification. Designed to meet EN, IEC, VDE and other international standards.

Isolated Power and Logic eliminates noise to provide reliable and stable operation.

DC Cooling Fan on many ratings eliminates the need for a transformer and voltage tapping; accommodates global usage.

Internal Logic Supply from DC Bus does not require separate control power wiring, improved ride-thru capability.

Communications. Designed to accommodate on-board communications for all ratings.

The 1336 PLUS II

The standard solution to your application needs.

The 1336 PLUS II provides ratings from 0.37-448 kW (0.5-600 HP) in three voltage ranges – 200-240V AC, 380-480V AC and 500-600V AC. The 1336 PLUS II is a micro-processor based adjustable frequency PWM AC drive. Its advanced design provides

exceptional reliability when controlling 3-phase motors. The output can be tuned to provide optimum performance for virtually any load condition. Selectable  or V/Hz operation provides outstanding motor control.

Simplicity

Design and programming simplicity is evident in:

- **Condensed packaging** that allows for easy mounting, installation and wiring in all types of applications.
- **Common assembly parts** that reduces the need to stock a multitude of parts.
- **Easy to program parameters** that are organized in a group and element structure for quick access to related functions.
- **Simple tuning** for optimum torque performance.

- **An easy to read Supertwist Liquid Crystal Display** gives 2 lines of 16 characters each for easy “one finger” programming and drive monitoring.
- **Serial communications** that provide easy integration and access to peripheral equipment – Fully compatible with all Allen-Bradley PLC® or SLC™ equipment.
- **Common options** that are used throughout the entire family of Drives.

Flexibility

Digitally programmable to help provide precise and accurate control.

The 1336 PLUS II uses digitally programmable features to achieve precise and consistently accurate control, setup and operation. The drive can be programmed locally from the Human Interface Module or through a serial communications port using a PLC, SLC, or **DriveTools™** programming software.

Configurable I/O allows simple connection to many customer preformed control schemes.

Control inputs and outputs can be programmed to meet nearly every application requirement.

Performance

Powerful algorithms provide unparalleled performance.



Starting acceleration and running torque in excess of 250% combined with a constant torque speed range of 120:1 allow the 1336 PLUS II to handle the tough applications other drives can't.

Specifications

Protection Specifications

	200-240V Drive	380-480V Drive	500-600V Drive
AC Input Overvoltage Trip	285V AC	570V AC	690V AC
AC Input Undervoltage Trip	138V AC	280V AC	343V AC
Bus Overvoltage Trip	405V DC	810V DC	1013V DC
Bus Undervoltage Trip	200V DC	400V DC	498V DC
Nominal Bus Voltage	324V DC	648V DC	810V DC
Heat Sink Thermistor	Monitored by microprocessor overtemp trip.		
Drive Overcurrent Trip	Software Current Limit: 20 to 160% of VT rated current. Hardware Current Limit: 180 to 250% of VT rated current (dependent on drive rating). Instantaneous Current Limit: 220 to 300% of VT rated current (dependent on drive rating).		
Line transients	Up to 6000 volts peak per IEEE C62.41-1991.		
Control Logic Noise Immunity	Showering arc transients up to 1500 volts peak.		
Power Ride-Thru	15 milliseconds at full load (refer to Page 13).		
Logic Control Ride-Thru	0.5 seconds minimum, 2 seconds typical (refer to Page 13).		
Ground Fault Trip	Phase-to-Ground on Drive Output.		
Short Circuit Trip	Phase-to-Phase on Drive Output.		

Environmental Specifications

Altitude	1000 m (3300 ft) maximum without derating. (refer to the Derating Guidelines on Pages 56-60).		
Ambient Operating Temperature	IP00, Open: 0 to 50 degrees C (32 to 122 degrees F). IP20, NEMA Type 1: 0 to 40 degrees C (32 to 104 degrees F). IP54, NEMA Type 12: 0 to 40 degrees C (32 to 104 degrees F). IP65, NEMA Type 4: 0 to 40 degrees C (32 to 104 degrees F). (refer to the Derating Guidelines on Pages 56-60).		
Storage Temperature (all constructions)	- 40 to 70 degrees C (- 40 to 158 degrees F).		
Relative Humidity	5 to 95% non-condensing.		
Shock	15G peak for 11 ms duration (±1.0 ms).		
Vibration	0.006 inches (0.152 mm) displacement, 1G peak.		
Agency Certification	U.L. Listed CSA Certified	 	
	Marked for all applicable directives ¹		
Emissions	EN 50081-1 EN 50081-2 EN 55011 Class A EN 55011 Class B		
Immunity	EN 50082-1 EN 50082-2 IEC 801-1, 2, 3, 4, 6, 8 per EN 50082-1, 2		
Low Voltage	EN 60204-1 PREN 50178		

¹ Note: Installation guidelines called out in Appendix C of the 1336 PLUS II User Manual (publication 1336 PLUS-5.3) must be adhered to.

Specifications

Input/Output Ratings

Requirements: Each 1336 PLUS II Drive has constant and variable torque capabilities.

Note: Drive ratings are at nominal values. Refer to Derating Guidelines on **Pages 56-60**.

Cat. No.	Constant Torque				Variable Torque				Variable Torque			
	Input kVA	Input Amps	Output kVA	Output Amps	Input kVA	Input Amps	Output kVA	Output Amps	Input kVA	Input Amps	Output kVA	Output Amps
	200-240V Drives				240V Drives							
AQF05	1.1	2.8	0.9	2.3	1.1	2.8	0.9	2.3				
AQF07	1.4	3.5	1.2	3.0	1.4	3.5	1.2	3.0				
AQF10	2.2	5.4	1.8	4.5	2.2	5.4	1.8	4.5				
AQF15	2.9	7.3	2.4	6.0	2.9	7.3	2.4	6.0				
AQF20	3.9	9.7	3.2	8.0	3.9	9.7	3.2	8.0				
AQF30	5.7	14.3	4.8	12	5.7	14.3	4.8	12				
AQF50	8.5	21.3	7.2	18	8.5	21.3	7.2	18				
AQF75	9.0	22.6	8.8	22	9.0	22.6	8.8	22				
A007	10-12	28	8.8	22	10	23	8.8	22				
A010	12-14	35	14	34	14	35	14	34				
A015	17-20	49	19	48	20	49	19	48				
A020	22-26	63	26	65	26	63	26	65				
A025	26-31	75	31	77	31	75	31	77				
A030	27-33	79	32	80	33	79	32	80				
A040	41-49	119	48	120	49	119	48	120				
A050	52-62	149	60	150	62	149	60	150				
A060	62-74	178	72	180	74	178	72	180				
A075	82-99	238	96	240	99	238	96	240				
A100	100-120	289	116	291	120	289	116	291				
A125	112-134	322	129	325	134	322	129	325				
	380-480V Drives				480V Drives				400V Drives			
BRF05	0.9-1.0	1.3	0.9	1.1	1.1	1.4	1.0	1.2	0.9	1.4	1.0	1.33
BRF07	1.3-1.6	2.0	1.3	1.6	1.7	2.1	1.4	1.7	1.4	2.1	1.4	1.89
BRF10	1.7-2.1	2.6	1.7	2.1	2.2	2.8	1.8	2.3	1.8	2.8	1.8	2.55
BRF15	2.2-2.6	3.3	2.2	2.8	2.8	3.5	2.4	3.0	2.3	3.5	2.4	3.33
BRF20	3.0-3.7	4.6	3.0	3.8	3.8	4.8	3.2	4.0	3.2	4.8	3.2	4.44
BRF30	4.2-5.1	6.4	4.2	5.3	5.7	7.2	4.8	6.0	4.7	7.2	4.8	6.66
BRF50	6.6-8.0	10.0	6.7	8.4	8.5	10.7	7.2	9.0	7.0	10.7	7.2	9.99
BRF75	8.9-11.3	13.6	10.6	13.3	13	15.7	12.3	15.4	10.3	15.7	12.3	19.43
BRF100	10.8-13.6	16.4	12.8	16.1	18.6	22.4	17.5	22	14.7	22.4	17.5	22.00
BRF150	16.1-20.4	24.5	19.1	24	20.4	24.5	19.1	24	16.1	24.5	19.1	24.00
BRF200	18-23	28	22	27	23	28	22	27	18	28	22	27.75
B015	16-21	25	19	24.2	23	28	22	27	18	28	22	29.97
B020	21-26	32	25	31	29	35	27	34	23	35	27	37.74
B025	26-33	40	31	39	36	43	33	42	28	43	33	46.62
B030	30-38	46	36	45	41	49	38	48	32	49	38	53.28
BX040	40-50	61	47	59	50	61	47	59	40	61	47	66.60
B040	38-48	58	48	60	52	63	52	65	41	63	52	72.15
B050	48-60	73	60	75	62	75	61	77	49	75	61	83.25
BX060 ¹	62	75	61	77	62	75	61	77	62	75	61	85.47
B060	54-68	82	68	85	77	93	76	96	61	93	76	106.56
B075	69-87	105	84	106	99	119	96	120	78	119	98	133.20
B100	90-114	137	110	138	124	149	120	150	98	149	120	166.50
B125	113-143	172	138	173	148	178	143	180	117	178	143	199.80
BX150	148	178	143	180	148	178	143	180	148	178	143	199.80
B150	130-164	197	159	199	198	238	191	240	157	238	191	266.40
B200	172-217	261	210	263	241	290	233	292	191	290	233	324.12
B250	212-268	322	259	325	268	322	259	325	212	322	259	360.75
BP/BPR250	212-268	322	259	325	297	357	287	360	235	357	287	399.60
BX250	212-268	322	259	325	297	357	287	360	228	357	279	399.60
B300	235-297	357	287	360	350	421	339	425	261	397	319	471.75
BP/BPR300	235-297	357	287	360	350	421	339	425	277	421	339	471.75
B350	277-350	421	339	425	392	471	378	475	294	446	359	527.25
BP/BPR350	277-350	421	339	425	392	471	378	475	310	471	378	527.25
B400	310-392	471	387	475	433	521	418	525	326	496	398	582.75
BP/BPR400	310-392	471	378	475	438	527	424	532	347	527	424	532.05
B450	343-433	521	418	525	486	585	470	590	372	565	454	654.90
BP/BPR450	347-438	527	424	532	438	527	424	532	347	527	424	532.00
B500	385-486	585	470	590	552	664	534	670	437	664	534	743.70
B600	437-552	664	534	670	552	664	534	670	437	664	534	743.70

¹480 Volts Only.

Specifications

Flexible Analog Inputs and Outputs

<p>Analog Option Card Slot A</p>	<p>No Option Card</p> <p>LA2</p> <p>LA6</p> <p>LA7</p>	<p>Two single-ended, non-isolated inputs configurable for a potentiometer reference, 0-10V, or 0-20 mA signal</p> <p>Dual Isolated Input Card</p> <p>Isolated Bipolar/Isolated Thermistor Input Card</p> <p>Isolated Bipolar Input/Isolated Input Card</p>
<p>Analog Option Card Slot B</p>	<p>No Option Card</p> <p>LA1</p> <p>LA3</p> <p>LA4</p> <p>LA5</p>	<p>One single-ended, non-isolated input configurable for a potentiometer reference, 0-10V, or 0-20 mA signal and two single-ended, non-isolated 0-10V only outputs.</p> <p>Dual Analog Output Card</p> <p>Dual Isolated Output Card</p> <p>Isolated Input/Isolated Output Card</p> <p>Analog Output/Pulse Output/Pulse Input Card</p>

Digital Inputs and Outputs

<p>Digital Input Specifications</p>	<p>Frequency Resolution:</p> <p>Maximum frequency programmed divided by 32767 (15 bits).</p> <p>60 Hz – 0.0018 Hz.</p> <p>100 Hz – 0.003 Hz.</p> <p>400 Hz – 0.012 Hz.</p>
<p>Contact Outputs</p>	<p>115V AC, 30V DC – 5.0 Amp Resistive – 2.0 Amp Inductive.</p> <p>(2) Form C Contacts.</p> <p>(2) Form A Contacts.</p> <p>All contacts are fully programmable for closure relative to 17 different drive variables selected through the “CR1-4 Out Select” parameters.</p>

Encoder Inputs

<p>Requirements</p>	<p>Line Driver Encoder 5V DC or 8-15V DC Output.</p> <p>Minimum Current – 10mA per Channel.</p> <p>Quadrature or Pulse.</p> <p>Single Ended or Differential.</p> <p>Maximum Input Frequency – 250 kHz</p>
---------------------	---

Serial Communications Options

<p>Remote I/O</p>	<p>Single drop remote I/O to Allen-Bradley PLCs and SLC 500. Supports full block transfer and link mode discrete transfer.</p>
<p>RS232/422/485</p>	<p>DFI Protocol – DH485 Protocol – Customer Specific Protocol.</p>
<p>DeviceNet™</p>	<p>DeviceNet to SCANport module – Available for all drive ratings.</p>
<p>Flex™ I/O</p>	<p>Flex I/O to SCANport module – Available for all drive ratings.</p>
<p>SLC</p>	<p>SLC to SCANport module – Available for all drive ratings.</p>

Sensorless Vector Motor Control

New vector control adds exceptional torque performance to the 1336 PLUS II. This powerful algorithm provides the following performance enhancements.



- Outstanding low speed torque at speeds as low as 15 rpm, providing a 120:1 constant torque speed range.
- Improved acceleration control can provide up to 250% breakaway/acceleration torque to move the toughest loads with ease.
- Solid "out-of-the-box" performance. Enhanced performance can be gained by programming the setup parameters with actual motor nameplate values. Optimum results can be achieved by programming the actual amps required to generate no load flux and the actual voltage needed for IR compensation. If these values are not known, setup procedures can determine the exact values.
- A fast accel mode is provided. Disabling the Adaptive Current Limit feature provides the lowest possible acceleration time for low inertia applications.
- A fast flux-up mode is programmable to aid in acceleration with large motors.
- Selectable Volts/Hertz modes are also available. When selected, they provide full functionality including Start Boost and Run Boost, Boost Slope and "Full Custom" V/Hz operation.

Process PI Control

Simple process control, monitoring a feedback device and adjusting drive output according to feedback requirements can be accomplished with the 1336 PLUS II Proportional and integral gain adjustments plus feedback scaling, error inversion, output clamping and integrator reset functions allow the Process PI function to control the output of the 1336 PLUS II based on the PI reference (setpoint) and the PI feedback. If the feedback device indicates that the process is moving away from the desired setpoint, the PI software responds by adjusting the drive output until the feedback again equals the setpoint. Selectable inputs provide "auto/manual" capability for open loop threading operation. Programmable presets and preloads assure smooth transitions.

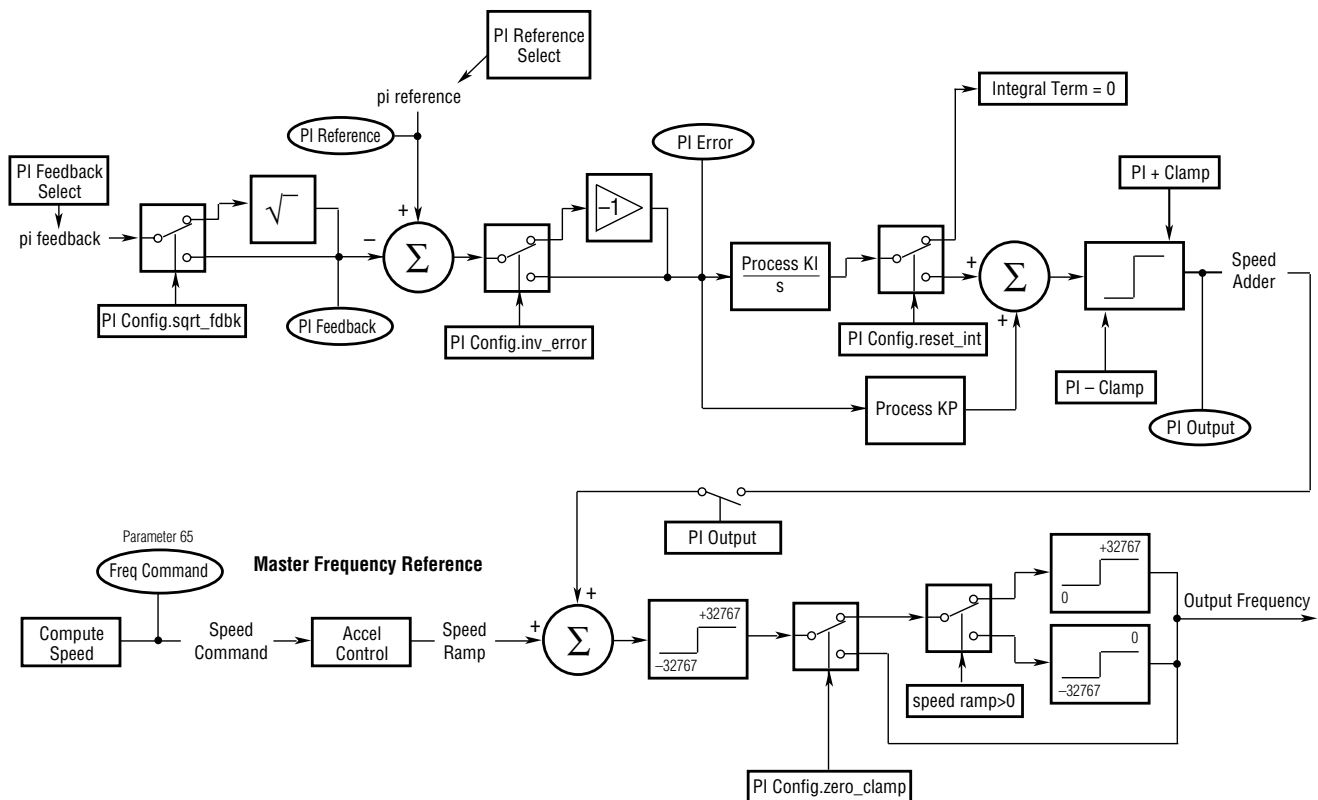

Function Description

Encoder Feedback

For those applications that require excellent speed regulation, the 1336 PLUS II offers optional encoder feedback. This option provides closed loop speed regulation from no load to full load of 0.1%. A feedback encoder and interface board (L4E, L5E or L6E*) with encoder inputs is required.

* The encoder loss detection feature of the 1336 PLUS II requires the use of L7E, L8E or L9E.

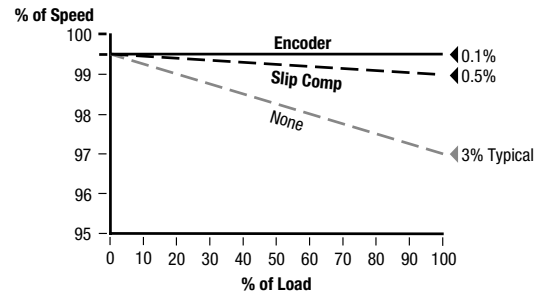

Slip Compensation

To develop torque in an induction motor, rotor speed “slips” relative to stator speed. The amount of slip is proportional to the motor load. While this increased slip provides the necessary torque, load speed is sacrificed. For those applications where this speed decrease is unacceptable, the 1336 PLUS II offers Slip Compensation. As load increases, the drive automatically increases output frequency to provide needed motor slip without a decrease in speed. The amount of compensation is proportional to the load increase, allowing one setting for the entire speed range. The 1336 PLUS II Slip Compensation function can provide typical speed regulation of 0.5%.

- Slip compensation is based on programmed motor flux instead of drive rated amps, providing more accurate speed regulation.
- Slip compensation is active for both steady state and accel/decel conditions.
- Dynamic response to load changes is parameter adjustable.
- Slip compensation enhances torque performance at all speeds.

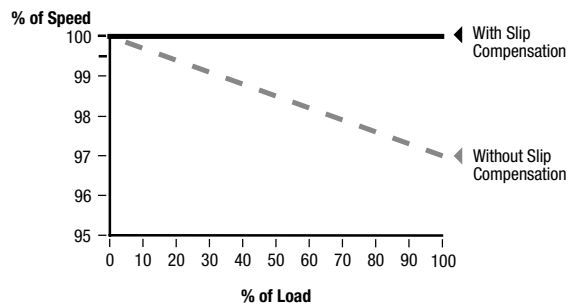

Flying Start

Some applications require that the drive “pick up” a spinning load at its current speed and direction, then accelerate or decelerate to the actual commanded speed and direction. The 1336 PLUS II offers a programmable feature called Flying Start. This feature has the ability to determine the speed and direction of a rotating motor and begin its output at that speed. The drive will then bring the motor to the commanded speed. Flying start can be accomplished with or without a motor mounted encoder.

Step Logic

The 1336 PLUS II can be programmed to perform seven logic steps with or without the use of a programmable controller. These steps can be based on:

- Time
- Digital Input
- Time and Digital Input
- Encoder Feedback Counts or Pulse Input Counts

The Step Logic is selected as a continuous loop or fault (End Fault).

Power Loss Ride-Thru

The 1336 PLUS II has the ability to ride through short power interruptions. On loss of input power to the drive, the drive offers two methods of operation.

With the Line Loss Fault parameter disabled, if a power interruption occurs (**T1**) the drive will continue to operate off stored DC bus energy until bus voltage drops to 85% of its nominal value (**T2**). At this point, the drive output is shut off, allowing the DC bus to discharge more slowly. The drive will retain its logic and operating status as long as bus voltage is above the absolute minimum bus voltage (refer to **Page 7**). If bus voltage should fall below this level (**T5**), the drive will trip and Undervolt Fault will be displayed. If input power is restored before this minimum is reached (**T3**) and bus voltage rises above the 85% level (**T4**), the drive will restore output power to the motor and resume running.

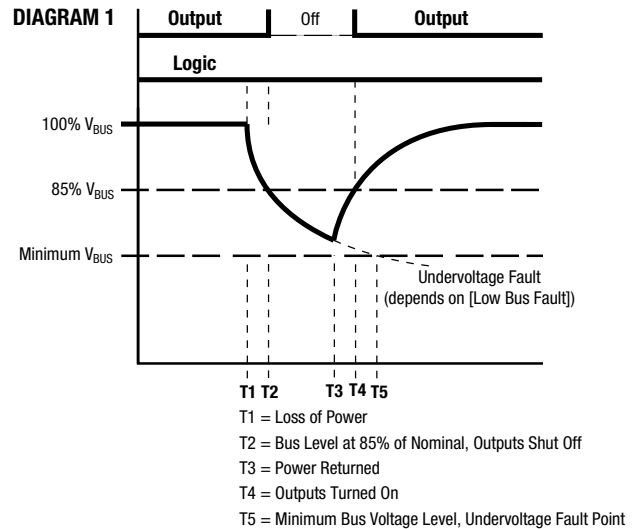

With the Line Loss Fault parameter enabled, if input power is lost (**T1**) the drive will continue to operate until the bus voltage falls below 85% of nominal (**T2**). At this point the drive output is turned off and a 500 mS timer is started. One of the following conditions will then occur:

1. The bus voltage will fall below minimum before the time expires (**T6**). This will generate an Undervoltage Fault.
2. The bus voltage will remain below 85% but above minimum and the timer expires (**T5**). This will generate a Line Loss Fault.
3. The input power is restored (**T3**) and the bus voltage rises above the 85% level before the timer expires (**T4**). This allows the drive to turn its output on and resume running.

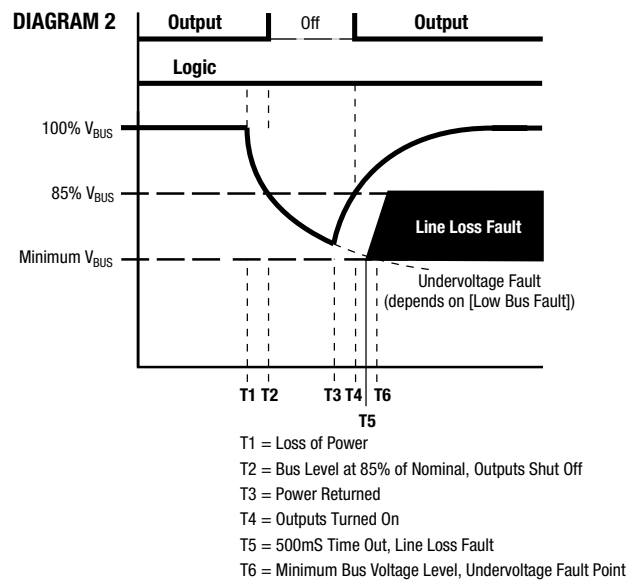

Line Loss Restart

In the event that a line loss condition occurs, the 1336 PLUS II provides a variety of programmable selections to control the timing and method of reconnecting the motor after power returns. Choices include:

- Use flying start to determine motor speed.
- Check for motor terminal voltage to determine motor speed.
- Read the encoder, if present.
- Reconnect at last known output frequency.

Function Description

Volts-per-Hertz

The 1336 PLUS II offers a fully programmable Volts-per-Hertz mode that allows maximum performance for applications requiring multiple motors on a common drive, particularly if the motors are not of equal size and type (i.e. a 3.7 kW/5 HP and 11 kW/15 HP motor on a 15 kW/20 HP drive).

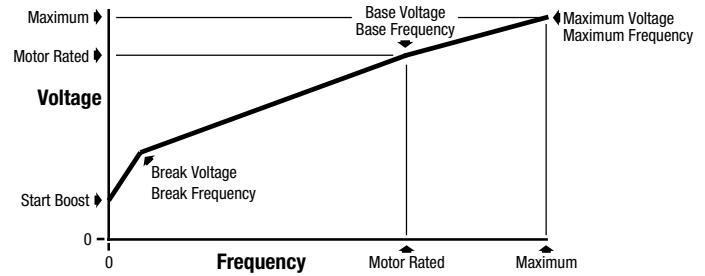

Motor Overload Protection

Motor I²t protection is separated from the drive power overload feature. The electronic motor overload operates independently to provide improved Class 10 protection. Operation at full load amps will raise the overload to approximately 70-80% of its trip level. Overloading beyond FLA will move the value towards tripping level (100%) based on I²t Trip curves are provided for both hot and cold states. Parameter settings include:

- Overload Amps from the motor nameplate FLA.
- Motor OL Fault parameter to disable the fault condition.
- In addition, Bit 14 (Motor OL Trip) of the Drive Alarm parameter is high (1) any time the existing level of output current will cause an Overload Fault to occur.

The overload feature remains speed sensitive with 3 derating choices:

- Max Derate is used for motors not designed for variable speed.
- Min Derate is used for motors with a 4:1 speed range (not intended for operation below 25% of base Speed).
- No Derate is used for variable speed motors with a speed range capability of 10:1 or better.

Overload Patterns

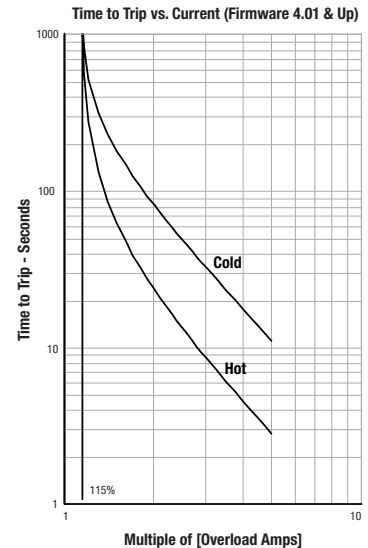
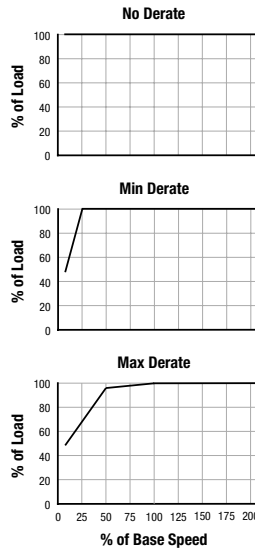

Auto Economizer

This feature combines stator flux control with an economizer routine to help the end user save energy costs. The Auto Economizer monitors drive current and compares it against the full load amps (Overload Amps) that the user has programmed into the drive. In load situations (i.e. idle) where the actual current draw of the motor is significantly less than the programmed overload amps, the drive will automatically begin reducing the output voltage to the motor. This minimizes flux current in a lightly loaded motor and results in a lower kW usage.

Braking

Many applications require a “holding brake” function to stop motor rotation between operations. The 1336 PLUS II provides a programmable DC Hold level and DC Hold time to develop holding torque in the motor after a ramp-to-stop.

For applications that require a quick stopping time, the 1336 PLUS II can “inject” a DC voltage into the motor for a programmed time to brake the motor to a stop. While this does not take the place of an external brake for emergency stopping, it is an effective stopping method under normal operation.

The drive is capable of extended or unlimited injection braking for both stopping and holding a motor. It provides:

- Injection braking at selectable levels for extended periods up to 90 seconds.
- Extended Hold Braking (up to 90 seconds).
- Continuous (event ended) Hold Braking. This is accomplished by setting the Stop mode to “Ramp to Hold”. In this mode, the drive will decelerate according to the programmed decel ramp. When the drive reaches zero Hertz output, it will supply programmed current for hold braking per the DC Hold Level parameter (limited to 70% of drive rating) until;
 - a) a Start command is issued,
 - or
 - b) the Enable input is opened.

Ramp-to-Stop

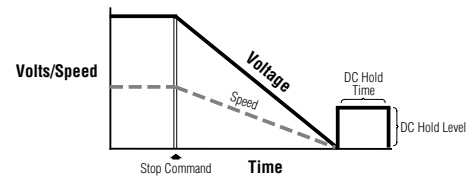

Brake-to-Stop

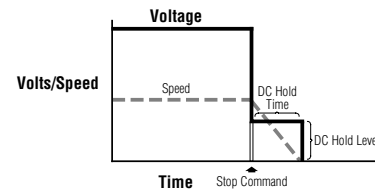

Ramp-to-Hold

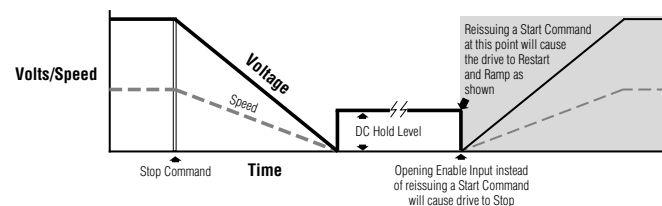

Reset/Run

The 1336 PLUS II offers the ability to automatically reset a fault (if the condition that causes the fault is no longer present) and restart. Both the number of reset attempts (0-9) and the time between reset attempts (0-30 Sec.) are programmable. If the condition causing the fault is still present when the number of “reset/run tries” is exceeded, the drive will shut down and issue a “Max Retries Exceeded” Fault. This feature will not operate for ground faults or shorted output faults.

Owners

The 1336 PLUS II displays which of the available adapters currently “owns” certain control functions. To avoid conflict, some owners are exclusive (only one device can issue a direction command), while others can have multiple control (many devices can simultaneously issue a start command). Owner displays are excellent diagnostic tools, displaying precisely where drive control commands are coming from.

0 0 0 0 0 0 1 0

Typical Owner Direction Command

Adapter 1 currently controlling direction

Masks

All external control connections to the 1336 PLUS II are made through a multi-connection communication bus called SCANport. A Frame drives have 5 available adapter ports while B Frame & larger drives have 6 ports. With the possibility of many devices able to issue drive control functions (start, stop, reverse, speed reference, etc.), the 1336 PLUS II offers a mask for each control function that gives the user complete flexibility to lock out any function (except stop) from any port.

1 1 1 0 1 1 1

Typical Jog Mask

Allows jog from Adapter 1
Denies jog from Adapter 3

Function Description

Traverse Function

The 1336 PLUS II output frequency can be programmed to modulate around a set frequency. This is accomplished by programming three parameters to develop an inertia compensated triangular waveform – Traverse Period, Max Traverse, and P Jump. In surface driven winding applications, the waveform developed can be used by traverse drives to perform the traverse function electronically.

A traverse drive will move the thread back and forth in a diamond pattern to distribute the thread evenly across a tube surface. To prevent a build up of thread at the same points on the surface, this pattern must be altered. This can be accomplished by continuously varying the speed of the traverse in a cyclical manner over a specified speed range. With the use of inertia compensation, the result is a series of distributed diamond patterns over the entire tube surface.

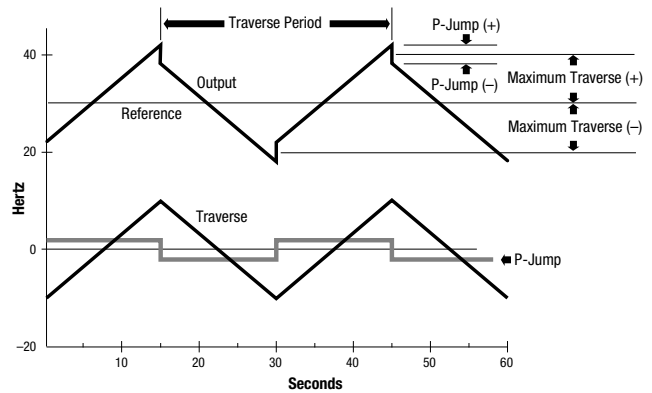

Run On Power Up

For applications that require unattended operation, the 1336 PLUS II offers the ability to resume running once power is restored after a power outage. If "Run On Power Up" is activated and input power is lost, when power is restored the drive will **automatically restart** and run at current command speed if all required signals are present (Enable, Auxiliary, Not-Stop and Start).

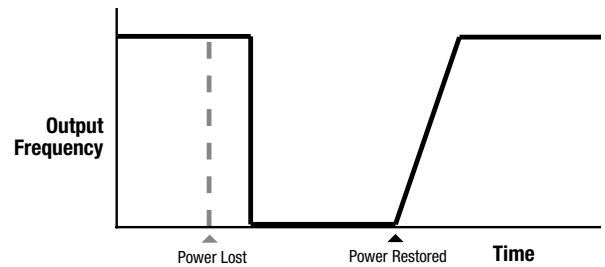

4-20mA Loss Select

Many control systems issue a 4-20 mA control signal for the drive to use as a speed reference. The drive will run at minimum speed with a 4 mA signal and maximum speed with a 20 mA signal. The drive can also invert this signal to run minimum speed at 20 mA and maximum speed at 4 mA. Since a minimum signal of 4 mA is required, the drive must have a "fall back" instruction in the event of a signal loss (failed transducer or broken wire). The 1336 PLUS II contains a "loss select" parameter that offers five choices for signal failure mode.

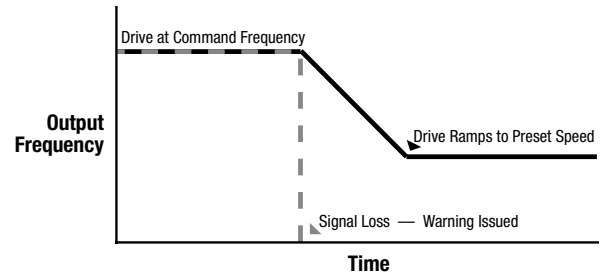

1. Stop the drive and issue a fault.
2. Go to minimum speed and issue a warning.
3. Go to maximum speed and issue a warning.
4. Maintain speed and issue a warning.
5. Go to a preset speed and issue a warning.

Function Description

Skip Frequencies

Many mechanical systems have resonant frequencies that can cause severe vibration. If these systems are run at these speeds continuously, this vibration can cause mechanical breakdowns. The 1336 PLUS II offers three programmable Skip Frequencies that prevent the drive from running continuously at resonant speeds. An additional parameter allows a programmable Skip Bandwidth around the skip frequencies

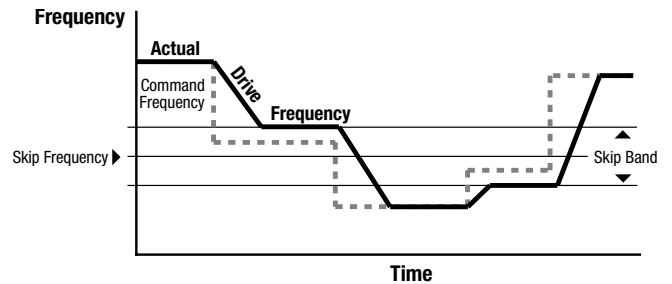

Process Display

In order to provide complete flexibility in monitoring drive performance, the 1336 PLUS II offers a Process Mode for the liquid crystal super-twist display on the Human Interface Module. This feature provides two lines of 16 characters each that can display any two drive parameters scaled into user selectable units. Each line uses 8 value display characters and 8 programmable text characters to create the process display. Simple keystrokes can designate the process display as the standard display shown at power up.

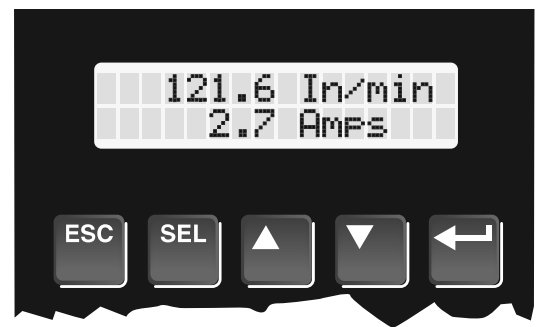

Fault Buffer

The 1336 PLUS II contains a fault buffer that records the last four faults the drive experienced. The buffer stores faults in a first-in first-out manner. Additional diagnostic parameters are listed in the Diagnostic Group (Refer to the Parameter List on **Page 18**).

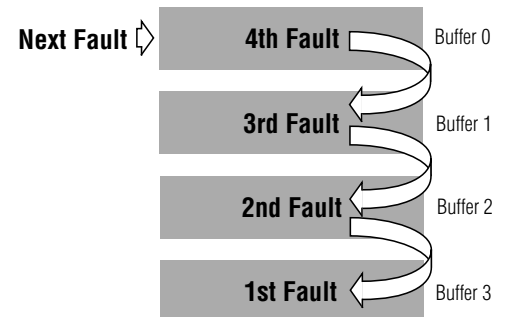

Parameter List

The 1336 PLUS II uses an extensive set of parameters divided into groups for ease of programming. Grouping replaces a sequentially numerical parameter list with functional parameter groups that increase operator efficiency and help reduce programming time.

Group/Param.	No.	Disp. Units	Min./Max. Values	Default
Metering				
Output Current	54	0.1A	0/200% Rtd. Drv. Out. Current	None
Output Voltage	1	1 Volt	0/200% Rtd. Drv. Out. Volts	None
Output Power	23	1 kW	±200% Rtd. Drv. Out. Power	None
DC Bus Voltage	53	1 Volt	0/200% DC Bus Volt Max.	None
Output Freq	66	0.01 Hertz	±400.00 Hz	None
Freq Command	65	0.01 Hertz	±400.00 Hz	None
Anlg In 0 Freq	138	0.01 Hertz	0.00/400.00 Hz	None
Anlg In 1 Freq	139	0.01 Hertz	0.00/400.00 Hz	None
Anlg In 2 Freq	140	0.01 Hertz	0.00/400.00 Hz	None
Encoder Freq	63	0.01 Hertz	0.00/400.00 Hz	None
Pulse Freq	254	0.01 Hertz	0.00/400.00 Hz	None
MOP Freq	137	0.01 Hertz	0.00/400.00 Hz	None
Heatsink Temp	70	1° C	0/255° C	None
Power OL Count	84	1 %	0/200%	None
Motor OL Count	202	1 %	0/200%	None
Last Fault	4	Fault #	None	None
Torque Current	162	0.1A	±200% Drive Rating	None
Flux Current	163	0.1A	±200% Drive Rating	None
% Output Power	3	1 %	±200% Drv. Rated Out. Power	None
% Output Curr	2	1 %	0/200% Rated Drv. Out. Curr.	None
Elapsed Run Time	279	0.1 Hr	0/6553.5	0
Setup				
Input Mode	241	Mode #	None	Status
Freq Select 1	5	Settings	Selection Parameter	Adapter 1
Accel Time 1	7	0.1 Second	0.0/3600.0 Sec	10.0 Sec
Decel Time 1	8	0.1 Second	0.0/3600.0 Sec	10.0 Sec
Minimum Freq	16	1 Hertz	0/120 Hz	0 Hz
Maximum Freq	19	1 Hertz	25/400 Hz	60 Hz
Stop Select 1	10	Settings	Selection Parameter	Coast
Current Limit	36	1%	20/300% (0.0/300.0***) Rated Amps	150%
Current Lmt Sel	232	Settings	Selection Parameter	Current Lmt
Adaptive 1 Lim	227	Settings	Selection Parameter	Coast
Overload Mode	37	Settings	Selection Parameter	No Derate
Overload Amps	38	0.1A	20/115% Drive Rated Amps	115% Drv. Rtd.
VT Scaling	203	Settings	Selection Parameter	Disabled
Motor NP RPM	177	1 RPM	60/24000 RPM	1750 RPM
Motor NP Hertz	178	1 Hertz	1/400 Hz	60 Hz
Motor NP Volts	190	1 Volt	0/2 x Drive Rated Volts	Drv. Rated Volts
Motor NP Amps	191	1 Amp	0/2 x Drive Rated Amps	Drv. Rated Amps
Advanced Setup				
Minimum Freq	16	1 Hertz	0/120 Hz	0 Hz
Maximum Freq	19	1 Hertz	25/400 Hz	60 Hz
PWM Frequency	45	2 kHz	2/8 kHz (A & B Frame)	Based on Drv Type
		2 kHz	2/6 kHz (C Frame & up)	Based on Drv Type
Accel Time 2	30	0.1 Second	0.0/3600.0 Sec	10.0 Sec
Decel Time 2	31	0.1 Second	0.0/3600.0 Sec	10.0 Sec
Sync Time	307	0.0 Second	0.0/6000.0 Sec	0.0 Sec
Stop Select 1	10	Display Drive	None	Coast
DC Hold Time	12	1 Second	0/90.0 Sec	0.0 Sec
DC Hold Level	13	1 %	0/150 %	100 %
Hold Level Sel	231	Settings	Selection Parameter	DC Hold Lvl
Bus Limit En	11	Settings	Selection Parameter	Disabled
Motor Type	41	Settings	Selection Parameter	Induction
Stop Select 2	52	Settings	Selection Parameter	Coast
KP Amps	193	NA	25/400	100
Speed Brake En*	319	Settings	Selection Parameter	Disabled
Frequency Setup				
Freq Select 1	5	Settings	Selection Parameter	Adapter 1
Freq Select 2	6	Settings	Selection Parameter	Preset 1
Jog Frequency	24	0.1 Hertz	0.0/400.0 Hz	10.0 Hz
Preset Freq 1	27	0.1 Hertz	0.0/400.0 Hz	0.0 Hz
Preset Freq 2	28	0.1 Hertz	0.0/400.0 Hz	0.0 Hz
Preset Freq 3	29	0.1 Hertz	0.0/400.0 Hz	0.0 Hz
Preset Freq 4	73	0.1 Hertz	0.0/400.0 Hz	0.0 Hz
Preset Freq 5	74	0.1 Hertz	0.0/400.0 Hz	0.0 Hz
Preset Freq 6	75	0.1 Hertz	0.0/400.0 Hz	0.0 Hz
Preset Freq 7	76	0.1 Hertz	0.0/400.0 Hz	0.0 Hz
Skip Freq 1	32	1 Hertz	0/400 Hz	400 Hz
Skip Freq 2	33	1 Hertz	0/400 Hz	400 Hz
Skip Freq 3	34	1 Hertz	0/400 Hz	400 Hz
Skip Freq Band	35	1 Hertz	0/15 Hz	0 Hz
MOP Increment	22	0.1 Hertz/Sec	0/78% [Max. Freq]/Sec	1.1 Hz/Sec
Save MOP Ref	230	Settings	Selection Parameter	Disabled
Freq Ref SqRoot	229	Settings	Selection Parameter	Disabled

Group/Param.	No.	Disp. Units	Min./Max. Values	Default
Frequency Setup (continued)				
Pulse In Scale	264	Factor	1/4096	1024 PPR
Encoder PPR	46	Factor	1/4096	1024 PPR
Feature Select				
Dwell Frequency	43	0.1 Hertz	0.0/7.0 Hz	0.0 Hz
Dwell Time	44	1 Second	0/10 Sec	0 Sec
Speed Control	77	Settings	Selection Parameter	Slip Comp
Slip @ F.L.A.	42	0.1 Hertz	0.0/10.0 Hz	1.0 Hz
Slip Comp Gain	195	None	1/40	1
Run On Power Up	14	Settings	Selection Parameter	Disabled
Reset/Run Tries	85	1 Try	0/9	0 Tries
Reset/Run Time	15	0.1 Second	0.5/30.0 Sec	1.0 Sec
S Curve Enable	57	Settings	Selection Parameter	Disabled
S Curve Time	56	0.1 Second	0.0/1800.0 Sec	0.0 Sec
Language	47	Settings	Selection Parameter	English
Flying Start En	155	Settings	Selection Parameter	Disabled
FStart Forward	156	1 Hz	0/400 Hz	60 Hz
FStart Reverse	157	1 Hz	0/400 Hz	0 Hz
LLoss Restart	228	Settings	Selection Parameter	Track Volts
LLoss Mode	256	Settings	Selection Parameter	LoBus>Off
LLoss Volts	320	1 Volt	40/80/100 Volts/200/400/500 Volts	59/117/146 Volts
Loss Recover	321	1 Volt	20/40/50 Volts/200/400/500 Volts	29/59/73 Volts
Ride Thru Volts	322	1 Volt	40/80/100 Volts/200/400/500 Volts	29/59/73 Volts
Min Bus Volts	323	1 Volt	100/200/250 Volts/200/400/500 Volts	194/388/485 Volts
Traverse Inc	78	0.01 Sec	0.00/30.00 Sec	0.00 Sec
Traverse Dec	304	0.01 Sec	0.00/30.00 Sec	0.00 Sec
Max Traverse	79	0.01 Hz	0.00/50% [Maximum Freq]	0.00 Hz
P Jump	80	0.01 Hz	0.00/25% [Maximum Freq]	0.00 Hz
Bus Regulation	288	Settings	Selection Parameter	Disabled
Load Loss Det	290	Settings	Selection Parameter	Disabled
Load Loss Level	291	1 %	0/100 %	0 %
Load Loss Time	292	1 Second	0/30 Sec	0 Sec
Bus Reg Level**/ Max Bus Volts*	325	1 Volt	358/716/895 Volts 403/807/1009 Volts	358/716/895 Volts
Digital I/O				
Input Mode	241	Mode #	Selection Parameter	Status
TB3 Term 22	242	Settings	Selection Parameter	Rev/For Input 3
TB3 Term 23	243	Settings	Selection Parameter	Jog Input 4
TB3 Term 24	244	Settings	Selection Parameter	Aux Fault Input 5
TB3 Term 26	245	Settings	Selection Parameter	Spd Sel 3 Input 6
TB3 Term 27	246	Settings	Selection Parameter	Spd Sel 2 Input 7
TB3 Term 28	247	Settings	Selection Parameter	Spd Sel 1 Input 8
Input Status	55	Settings	Selection Parameter	
CR1 Out Select	158	Settings	Selection Parameter	At Speed
CR2 Out Select	174	Settings	Selection Parameter	Running
CR3 Out Select	175	Settings	Selection Parameter	Fault
CR4 Out Select	176	Settings	Selection Parameter	Alarm
Dig Out Freq	159	0.01 Hz	0.00 Hz [Maximum Freq]	0.00 Hz
Dig Out Current	160	0%	0/200%	0%
Dig Out Torque	161	0.1A	0.0/200% of [Rated Amps]	0.0A
Dig At Temp	267	1° C	0/255° C	0
PI Max Error	293	0.01 Hz	±400.00 Hz	None
Pulse Out Select	280	Settings	Selection Parameter	Output Freq
Pulse Out Scale	281	Factor	1/4096	1024 PPR
Pulse In Scale	264	Factor	1/4096	1024 PPR
At Time*	327	0.01 Sec	0.00/360.00	0.00 Sec
Remote CR Output*	326	Settings	None	xxxx0000
Analog I/O				
Anlg In 0 Lo	237	0.1 %	±300.0%	0.0%
Anlg In 0 Hi	238	0.1 %	±300.0%	100.0%
Anlg In 1 Lo	239	0.1%	±300.0%	0.0%
Anlg In 1 Hi	240	0.1%	±300.0%	100.0%
Anlg In 2 Lo	248	0.1%	±300.0%	0.0%
Anlg In 2 Hi	249	0.1%	±300.0%	100.0%
Analog Trim En	90	Settings	Selection Parameter	Disabled
Anlg Signal Loss	250	Settings	Selection Parameter	Disabled
4-20mA Loss Sel	150	Settings	Selection Parameter	Min/Alarm
Anlg Out 0 Sel	25	Settings	Selection Parameter	Frequency
Anlg Out 0 Offset	154	Disabled	Selection Parameter	Disabled
Anlg Out 0 Abs	233	Disabled	Selection Parameter	Enabled
Anlg Out 0 Lo	234	0.1%	±300.0%	0.0%
Anlg Out 0 Hi	235	0.1%	±300.0%	100.0%
Anlg Out 1 Sel	274	Settings	Selection Parameter	Current
Anlg Out 1 Abs	277	Enabled	Selection Parameter	Enabled
Anlg Out 1 Offset	278	Enabled	Selection Parameter	Disabled
Anlg Out 1 Lo	275	0.1%	±300.0%	0.0%
Anlg Out 1 Hi	276	0.1%	±300.0%	100.0%
Slot A Option	252	Settings	Selection Parameter	Standard
Slot B Option	253	Settings	Selection Parameter	Standard
*Firmware 3.001 & later				
**Firmware 4.001 & later				
***Firmware 5.001 & later				

Parameter List

Group/Param.	No.	Disp. Units	Min./Max. Values	Default
Faults				
Fault Buffer 0	86	Fault Code	Fault Storage	None
Fault Buffer 1	87	Fault Code	Fault Storage	None
Fault Buffer 2	88	Fault Code	Fault Storage	None
Fault Buffer 3	89	Fault Code	Fault Storage	None
Clear Fault	51	Settings	Selection Parameter	Ready
Cur Lim Trip En	82	Settings	Selection Parameter	Disabled
Shear Pin Fault	226	Settings	Selection Parameter	Disabled
Motor OL Fault	201	Settings	Selection Parameter	Enabled
Motor Therm Fit	268	Fault Code	Fault Storage	Enabled
Line Loss Fault	40	Settings	Selection Parameter	Disabled
Blwn Fuse Fit	81	Settings	Selection Parameter	Enabled
Low Bus Fault	91	Settings	Selection Parameter	Enabled
Fault Data	207	Param. #	1/255	None
Fit Motor Mode	143	Settings	Read Only	None
Fit Power Mode	144	Settings	Read Only	None
Fault Frequency	145	0.01 Hertz	0.00/400.00 Hz	None
Fault Status 1	146	Bit 1/0	Read Only	None
Fault Status 2	286	Fault Code	Fault Storage	None
Fault Alarms 1	173	Bit 1/0	Read Only	None
Fault Alarms 2	287	Fault Code	Fault Storage	None
Fit Clear Mode	39	Settings	Selection Parameter	Enabled
Ground Warning	204	Settings	Selection Parameter	Disabled
Phase Loss Mode*	330	Settings	Selection Parameter	Disabled
Phase Loss Level*	331	0.1 Volts	5.1/10.1/12.7volts/22.5/45.0/56.2 Volts	9.0/18.0/22.5 Volts
Precharge Fault*	332	Settings	Selection Parameter	Enabled
Diagnostics				
Drive Status 1	59	Bit 1/0	Read Only	None
Drive Status 2	236	Bit 1/0	Read Only	None
Application Sts	316	Bit 1/0	Read Only	None
Drive Alarm 1	60	Bit 1/0	Read Only	None
Drive Alarm 2	269	Bit 1/0	Read Only	None
Latched Alarms 1	205	Bit 1/0	Read Only	None
Latched Alarms 2	270	Bit 1/0	Read Only	None
Input Status	55	Bit 1/0	Read Only	None
Freq Source	62	Settings	Read Only	Use Last
Freq Command	65	0.01 Hertz	±400.00	None
Drive Direction	69	Settings	Read Only	None
Stop Mode Used	26	Settings	Read Only	Coast
Motor Mode	141	Settings	Read Only	None
Power Mode	142	Settings	Read Only	None
Output Pulses	67	1 Pulse	0/65535	None
Current Angle	72	1 Deg.	Read Only	None
Heatsink Temp	70	1° C.	0/255° C	None
Set Defaults	64	Settings	Selection Parameter	Ready
DC Bus Memory	212	1 Volt	Read Only	None
Meas. Volts	272	1 Volt	Read Only	None
EEPROM Cksum	172	None	Read Only	None
Ratings				
Rated Volts	147	1 Volt	Read Only	Drive Rating
Rated Amps	170	0.1 A	Read Only	Drive Rating
Rated kW	171	kW	Read Only	Drive Rating
Firmware Ver.	71	None	Read Only	0.00
Cntrl Board Rev	251	None	Read Only	0.00
Rated CT Amps	148	0.1A	Read Only	Drive Rating
Rated CT kW	149	kW	Read Only	Drive Rating
Rated VT Amps	198	0.1A	Read Only	Drive Rating
Rated VT kW	199	kW	Read Only	Drive Rating
Drive Type	61	None	Read Only	Drive Rating
Masks				
Direction Mask	94	Bit 1/0	0/1	01111110
Start Mask	95	Bit 1/0	0/1	01111111
Jog Mask	96	Bit 1/0	0/1	01111111
Reference Mask	97	Bit 1/0	0/1	01111111
Accel Mask	98	Bit 1/0	0/1	01111111
Decal Mask	99	Bit 1/0	0/1	01111111
Fault Mask	100	Bit 1/0	0/1	01111111
MOP Mask	101	Bit 1/0	0/1	01111111
Traverse Mask	305	Bit 1/0	0/1	01111111
Sync Mask	308	Bit 1/0	0/1	01111111
Logic Mask	92	Bit 1/0	0/1	01111111
Local Mask	93	Bit 1/0	0/1	01111111
Alarm Mask 1	206	Bit 1/0	0/1	01111111
Alarm Mask 2	271	Bit 1/0	0/1	01111111
Owners				
Stop Owner	102	Bit 1/0	Read Only	None
Direction Owner	103	Bit 1/0	Read Only	None
Start Owner	104	Bit 1/0	Read Only	None
Jog Owner	105	Bit 1/0	Read Only	None
Reference Owner	106	Bit 1/0	Read Only	None
Accel Owner	107	Bit 1/0	Read Only	None
Decal Owner	108	Bit 1/0	Read Only	None
Fault Owner	109	Bit 1/0	Read Only	None

Group/Param.	No.	Disp. Units	Min./Max. Values	Default
Owners (continued)				
MOP Owner	110	Bit 1/0	Read Only	None
Traverse Owner	306	Bit 1/0	Read Only	None
Sync Owner	309	Bit 1/0	Read Only	None
Local Owner	179	Bit 1/0	Read Only	None
Adapter I/O				
Data In (8)	111-118	Parameter #	None	0
Data Out (8)	119-126	Parameter #	None	0
Alt Type 2 Cmd	315	Settings	Selection Parameter	Disabled
Process Display				
Process 1 Par	127	Parameter #	None	1
Process 1 Scale	128	Numeric	±327.67	+1.00
Process 1 Txt 1-8	129-136	ASCII Code	None	Volts
Process 2 Par	180	Parameter #	None	54
Process 2 Scale	181	Numeric	±327.67	+1.00
Process 2 Txt 1-8	182-189	ASCII Code	None	Amps
Encoder Feedback				
Speed Control	77	Settings	Selection Parameter	Slip Comp
Encoder Type	152	Settings	Selection Parameter	Quadrature
Encoder PPR	46	Factor	1/4096	1024 PPR
Maximum Speed	151	1 Hertz	0/400 Hz	400 Hz
Motor Poles	153	1 Pole	Read Only	None
Speed KI	165	Numeric	0/20000	100
Speed KP	164	Numeric	0/20000	0
Speed Error	166	0.01 Hz	±8.33% [Base Frequency]	None
Speed Integral	167	0.01 Hz	±8.33% [Base Frequency]	None
Speed Adder	168	0.01 Hz	±8.33% [Base Frequency]	None
Slip Adder	255	0.01 Hz	±8.33% [Base Frequency]	None
Motor NP RPM	177	1 RPM	60/24000 RPM	1750 RPM
Motor NP Hertz	178	1 Hertz	1/400 Hz	60 Hz
Encoder Counts	283	1 Count	±32767	0
Enc Count Scale	282	Settings	0/4096	None
Encoder Loss Sel	284	Settings	Selection Parameter	Disabled
Encoder Freq	63	0.01 Hertz	0.00/400.00 Hz	None
Max Enc Counts*	328	1 Count	0/32767	0
Process PI				
Speed Control	77	Settings	Selection Parameter	Slip Comp
PI Config	213	Bit 1/0	0/1	00000000
PI Status	214	Bit 1/0	Read Only	None
PI Ref Select	215	Settings	Selection Parameter	Preset 1
PI Fdbk Select	216	Settings	Selection Parameter	Analog In 1
PI Reference	217	0.01 Hertz	±400.00 Hz	None
PI Feedback	218	0.01 Hertz	±400.00 Hz	None
PI Error	219	0.01 Hertz	±400.00 Hz	None
PI Output	220	0.01 Hertz	±400.00 Hz	None
KI Process	221	N/A	0/1024	128
KP Process	222	N/A	0/1024	256
PI Neg Limit	223	0.01 Hz	±400.00 Hz	-8.33% [Max Freq]
PI Pos Limit	224	0.01 Hz	±400.00 Hz	+8.33% [Max Freq]
PI Preload	225	0.01 Hz	±8.33 [Max Freq]	0.00 Hz
Motor Control				
Control Select	9	Settings	Selection Parameter	Sens Vector
Flux Amps Ref	192	0.1A	0.0/75% Drive VT Rtd. Amps	0.0A
IR Drop Volts	194	1 Volt	0/25% Drive Rated Voltage	0 Volts
Flux Up Time	200	0.1 Sec	0.0/5.0 Sec	0.0 Sec
Start Boost	48	1 Volt	0/9.5% Drive Rated Voltage	0 Volts
Run Boost	83	1 Volt	0/9.5% Drive Rated Voltage	0 Volts
Boost Slope	169	None	1.0/8.0	1.5
Break Voltage	50	1 Volt	0/50% Drive Rated Voltage	25% Drive Rtd. V
Break Frequency	49	1 Hertz	0/120 Hz	25% [Max. Freq]
Base Voltage	18	1 Volt	25/120% Drive Rated Voltage	Drive Rtd. Volts
Base Frequency	17	1 Hertz	25/400 Hz	60 Hz
Maximum Voltage	20	1 Volt	25/120% Drive Rated Voltage	Drive Rtd. Volts
Run/Accel Volts	317	1%	50%/100%	100%
Sync Loss Sel	310	Settings	Selection Parameter	Disabled
Sync Loss Gain	311	Numeric	0/100	40
Sync Loss Comp	313	1 Volt	0/25% of Drive Rtd. Volts	0 Volts
Sync Loss Time	312	1 Sec	1/30 Sec	5 Sec
PWM Comp Time**	333	None	20/90	80
Break Freq**	334	0.01 Hz	0/30 Hz	0 Hz
Step Logic				
SLx Logic Step***	335-371	Settings	Selection Parameter	Step On Time
SLx Logic Jump***	336-372	Settings	Selection Parameter	Do Not Step
SLx Step Jump***	337-373	Settings	Selection Parameter	Jump to 0
SLx Step Setting***	338-374	Bit 1/0	0/1	xxxx0000
SLx Time***	339-375	0.01 Sec	0.00/600.00	0.00 Sec
SLx Encoder Cnts****	340-376	1 Count	±32767	0
Current Step	377	None	0/9	0

*Firmware 3.001 & later
 **Firmware 4.001 & later
 ***Firmware 5.001 & later

Fault List

Over 40 faults can be displayed through the Human Interface Module. The display indicates a fault by showing a brief text statement relating to the fault that will be displayed until a drive reset is initiated.

Fault No.	Display Name	Fault Description
02	Auxiliary Fault	The auxiliary input interlock is open
03	Power Loss Fault	DC bus voltage remained below 85% of nominal for longer than 500ms
04	Undervolt Fault	DC Bus voltage fell below the minimum value
05	Overvolt Fault	DC bus voltage exceeded maximum value
06	Motor Stall Fault	Current remained over 150% of [Rated Amps] for more than 4 seconds
07	Overload Fault	Internal electronic overload trip
08	Overtemp Fault	Heatsink temperature exceeds a predefined value of 90° C (195° F)
09	Open Pot Fault	An external pot is connected and the common side of the pot is open
10	Serial Fault	A SCANport adapter has been disconnected and the [Logic Mask] bit for that adapter is set to "1"
11	Op Error Fault	A SCANport device requests a Read or Write of data type not supported
12	Overcurrent Flt	Overcurrent is detected in instantaneous overcurrent trip circuit
13	Ground Fault	A current path to earth ground in excess of 100A has been detected at one or more of the drive output terminals
14	Option Error	An analog option board has been installed in the wrong slot
15	Motor Thermistor	An analog option board with thermistor input is installed and the value at the terminals is less than 60 ohms or greater than 3300 ohms
16	Bipolar Dir Flt	3 Wire-Bipolar input is the active frequency reference and direction control is not possible 2 Wire-Run Forward or Run Reverse commands attempt direction control, but bipolar input is not masked from direction control
19	Precharge Fault	The precharge device was open 20ms after the end of a line loss condition or the bus charging alarm remains on for 20 seconds
22	DSP Reset Fault	Power-up has been attempted with an Open Stop contact or Closed Start contact
23	Loop Overrn Fault	An overrun of the 2.5ms control loop has occurred
24	Motor Mode Fault	A fault has been detected originating from the Control Board
26	Power Mode Fault	The internal power mode variable received an incorrect value
29	Hertz Err Fault	This fault indicates that there is not a valid operating frequency
30	Hertz Sel Fault	A frequency select parameter has been programmed with an out-of-range value
32	EEPROM Fault	EEPROM is being programmed and will not write a new value
33	Max Retries Fault	Drive unsuccessfully attempted to reset a fault and resume running for the programmed number of tries
34	Prm Access Flt	A communication error occurred between the microprocessor and serial EEPROM or DSP
35	Neg Slope Fault	Drive software detected a portion of the v/hz curve with a negative slope
36	Diag C Lim Flt	The [Cur Lim Trip En] parameter was enabled
38	Phase U Fault	A phase-to-ground fault has been detected between the drive and motor in this phase
39	Phase V Fault	A phase-to-ground fault has been detected between the drive and motor in this phase
40	Phase W Fault	A phase-to-ground fault has been detected between the drive and motor in this phase
41	UV Short Fault	Excessive current has been detected between these two output terminals
42	UW Short Fault	Excessive current has been detected between these two output terminals
43	VW Short Fault	Excessive current has been detected between these two output terminals
47	Xsistr Desat Flt	Output transistor(s) operating in the active region instead of desaturation. (Frame C & Above)
48	Reprogram Fault	The drive was commanded to write default values to EEPROM
49	Input Phase Flt	The drive is operated on single phase power
50	Poles Calc Fault	Generated if the calculated value of [Motor Poles] is less than 2 or greater than 32
51	Bgnd 10ms Over	Microprocessor loop fault
52	Fgnd 10ms Over	Microprocessor loop fault
53	EE Init Read	Trouble reading EEPROM during initialization or gate drive board needs replacing
54	EE Init Value	Stored parameter value out of range on initialization
55	Temp Sense Open	Heatsink thermistor is open or malfunctioning
56	Precharge Open	The precharge circuit was commanded to close, but was detected to be open
57	Ground Warning	A current path to earth ground in excess of 2A has been detected at one or more of the drive output terminals
58	Blwn Fuse Flt	The bus fuse in 30kW (40 HP) and up drives has blown
61	Mult Prog Input	A single source input function has been programmed to more than one input or more than one "Run Reverse" input
62	Ill Prog Input	[Fault Data] = 98: "3 Wire" is selected as the [Input Mode] and one or more digital inputs are programmed to "Run Reverse"
63	Shear Pin Fault	Programmed [Current Limit] amps has been exceeded
64	Power Overload	The drive rating of 150% for 1 minute has been exceeded
65	Adptr Freq Err	The SCANport adapter sent an illegal frequency reference to the drive
66	EEPROM Checksum	The checksum read from the EEPROM does not match the checksum calculated from the EEPROM data
68	ROM or RAM Flt	Internal power-up ROM or RAM tests have not executed properly
69	Step Logic Flt	[SLx Step Jump] is set to "End Fault" or [Encoder Counts] has reached the endpoint of ±32767

1336 PLUS II Pre-Installation

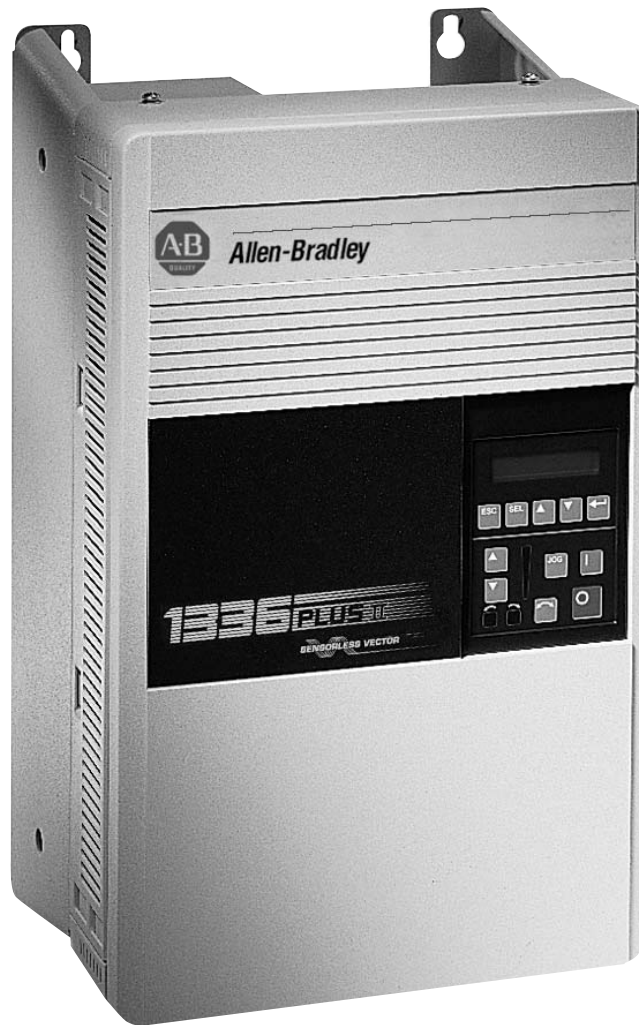

ATTENTION: The following information is merely a guide for proper installation. The Allen-Bradley Company cannot assume responsibility for the compliance or the noncompliance to any code, national, local or otherwise for the proper installation of this drive or associated equipment.

A hazard of personal injury and/or equipment exists if codes are ignored during installation.

Pre-Installation

IP 20 (NEMA Type 1) Dimensions – Frames A1 Through A4

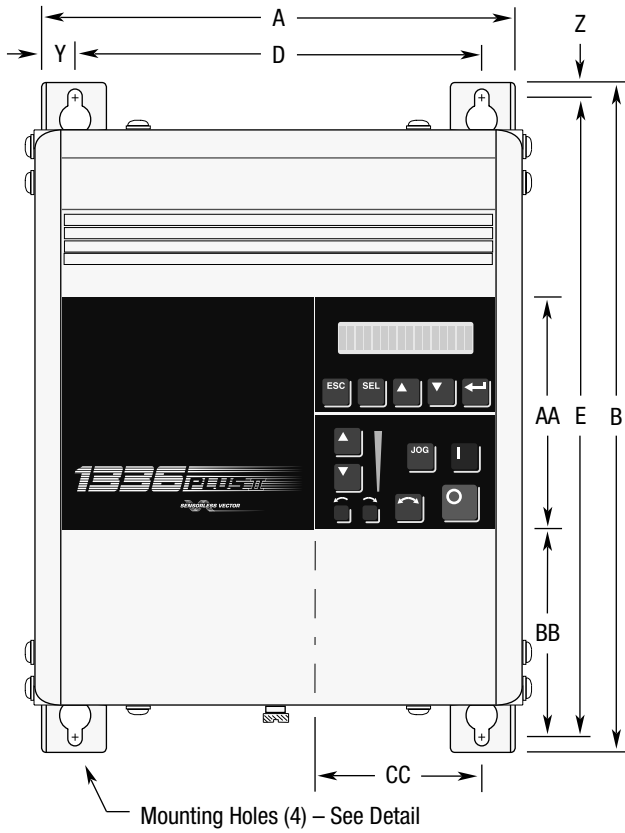

Mounting Hole Detail

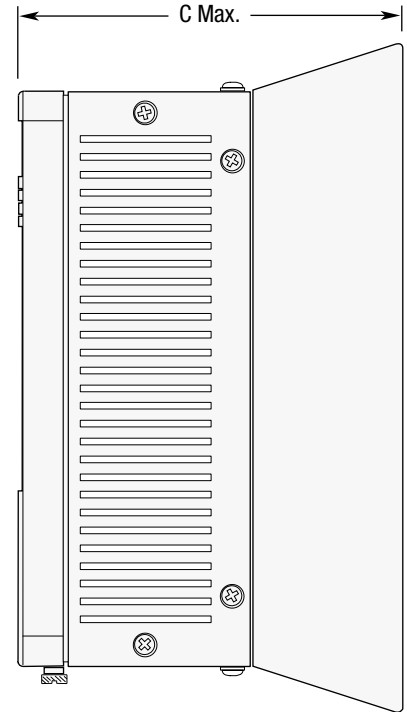
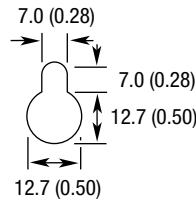

Bottom View Will Vary with HP – See Bottom View Dimensions

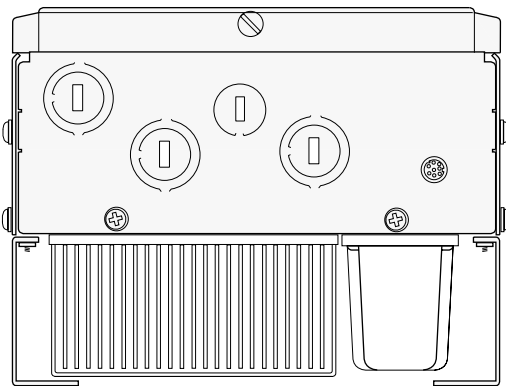

Three-Phase Rating ^{1,2}			Frame Reference
200-240V	380-480V	500-600V	A1
0.37-0.75 kW	0.37-1.2 kW	–	
0.5-1 HP	0.5-1.5 HP	–	
1.2-1.5 kW	1.5-2.2 kW	–	A2
1.5-2 HP	2-3 HP	–	
2.2-3.7 kW	3.7 kW	–	A3
3-5 HP	5 HP	–	
–	5.5-15 kW *	0.75-15 kW	A4
–	7.5-20 HP	1-20 HP	
5.5-11 kW	11-22 kW *	–	B1/B2
7.5-15 HP	15-30 HP	–	
15-22 kW	30-45 kW	18.5-45 kW	C
20-30 HP	40-60 HP	25-60 HP	
30-45 kW	45-112 kW	56-93 kW	D
40-60 HP	60-150 HP	75-125 HP	
56-93 kW	112-187 kW	112-187 kW	E
75-125 HP	150-250 HP	150-300 HP	
–	187-336 kW	261-298 kW	F
–	250-450 HP	350-400 HP	
–	187-448 kW	224-448 kW	G
–	250-600 HP	300-600 HP	

All Dimensions in Millimeters and (Inches)
All Weights in Kilograms and (Pounds)

* Use care when choosing Frame Reference - Some ratings may exist in another frame size.

Frame Reference	A	B	C Max.	D	E	Y	Z	AA	BB	CC	Shipping Weights
A1	215.9 (8.50)	290.0 (11.42)	160.0 (6.30)	185.2 (7.29)	275.0 (10.83)	15.35 (0.60)	7.5 (0.30)	130.0 (5.12)	76.2 (3.00)	85.3 (3.36)	4.31 (9.5)
A2	215.9 (8.50)	290.0 (11.42)	180.5 (7.10)	185.2 (7.29)	275.0 (10.83)	15.35 (0.60)	7.5 (0.30)	130.0 (5.12)	76.2 (3.00)	85.3 (3.36)	5.49 (12.1)
A3	215.9 (8.50)	290.0 (11.42)	207.0 (8.15)	185.2 (7.29)	275.0 (10.83)	15.35 (0.60)	7.5 (0.30)	130.0 (5.12)	76.2 (3.00)	85.3 (3.36)	6.71 (14.8)
A4	260.0 (10.24)	350.0 (13.78)	212.0 (8.35)	230.0 (9.06)	320.0 (12.60)	15.35 (0.60)	15.35 (0.60)	130.0 (5.12)	133.0 (5.23)	86.0 (3.39)	15.90 (35.0)

¹ Refer to the Derating Guidelines on Pages 56-60 for derating information.

² kW/HP are constant torque (CT) ratings.

IP 20 (NEMA Type 1) Dimensions – Frames B, C, D

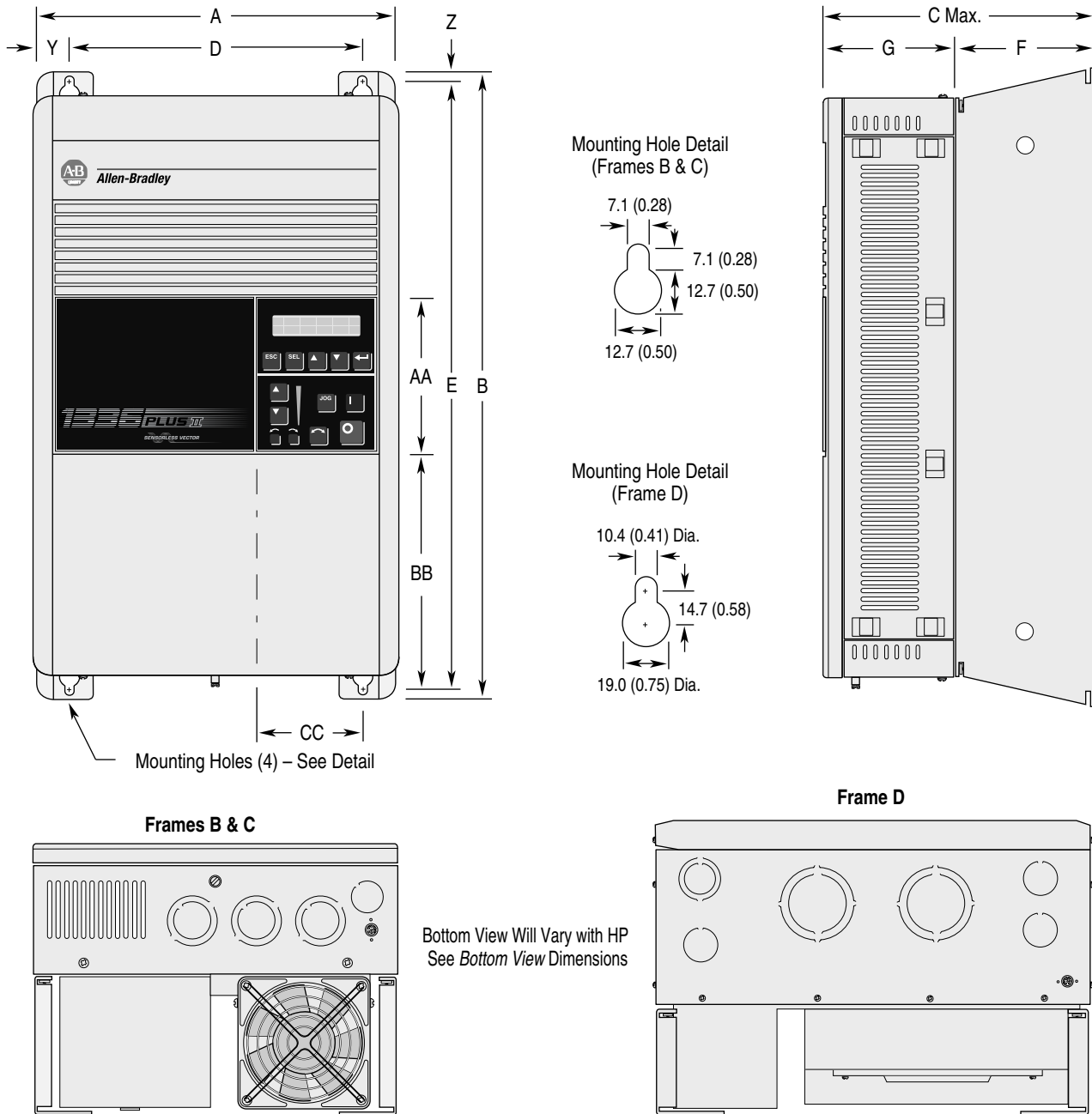

All Dimensions in Millimeters and (Inches)
All Weights in Kilograms and (Pounds)

Frame Reference	A	B	C Max.	D	E	F	G		Y	Z	AA	BB	CC	Shipping Weight
							Encl.	Open						
B1/B2	276.4 (10.88)	476.3 (18.75)	225.0 (8.86)	212.6 (8.37)	461.0 (18.15)	131.6 (5.18)	93.5 (3.68)	88.9 (3.50)	32.00 (1.26)	7.6 (0.30)	131.1 (5.16)	180.8 (7.12)	71.9 (2.83)	22.7 kg (50 lbs.)
C	301.8 (11.88)	701.0 (27.60)	225.0 (8.86)	238.0 (9.37)	685.8 (27.00)	131.6 (5.18)	93.5 (3.68)	88.9 (3.50)	32.00 (1.26)	7.6 (0.30)	131.1 (5.16)	374.7 (14.75)	71.9 (2.83)	38.6 kg (85 lbs.)
D	381.5 (15.02)	1240.0 (48.82)	270.8 (10.66)	325.9 (12.83)	1216.2 (47.88)	81.3 (3.20)	189.5 (7.46)	184.9 (7.28)	27.94 (1.10)	11.94 (0.47)	131.1 (5.16)	688.6 (27.11)	83.6 (3.29)	108.9 kg (240 lbs.)

IP 20 (NEMA Type 1) & Open Dimensions – Frame F

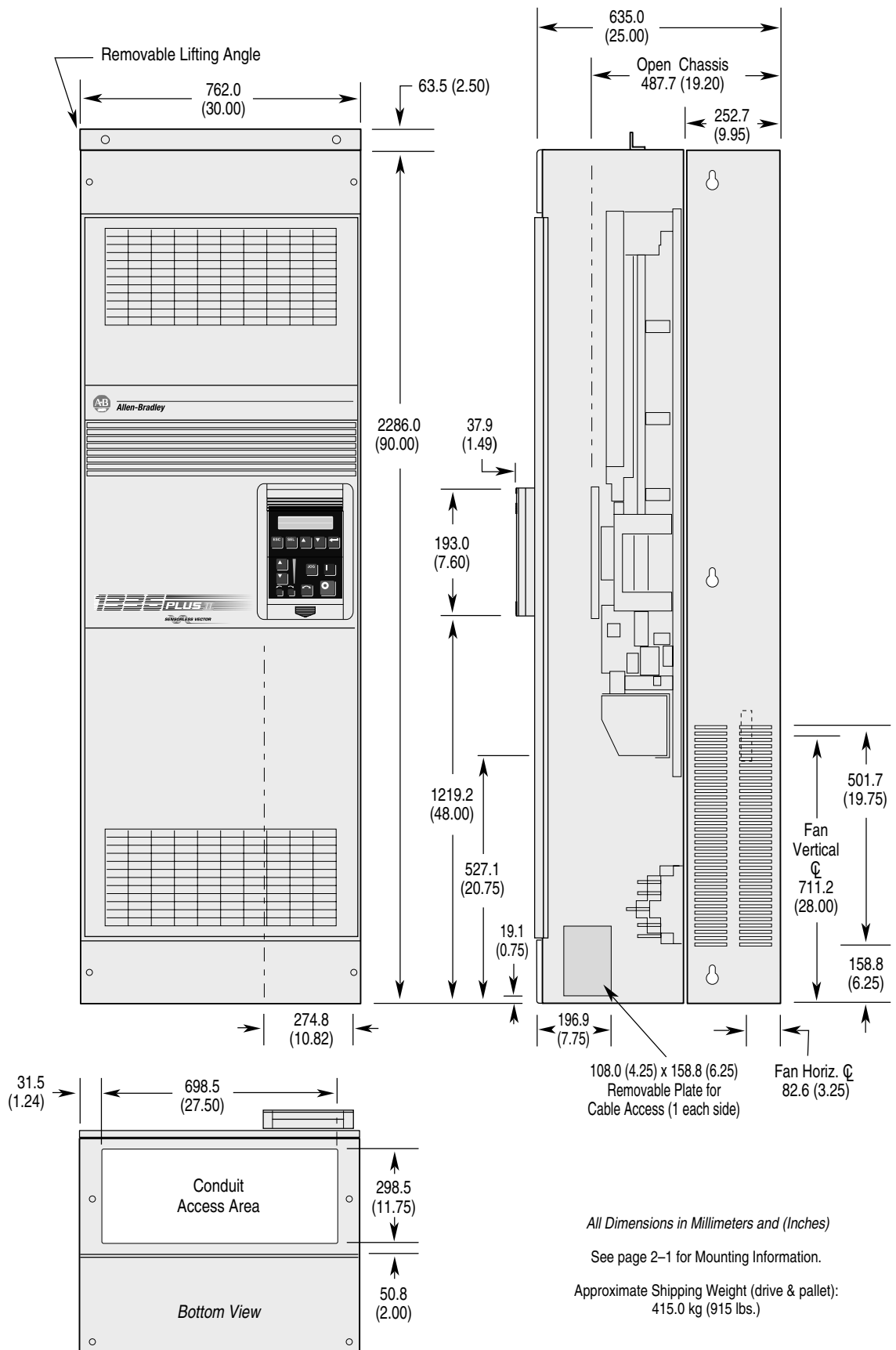

Pre-Installation

Open Dimensions – Frame F “Roll-In” Chassis

All Dimensions in Millimeters and (Inches)

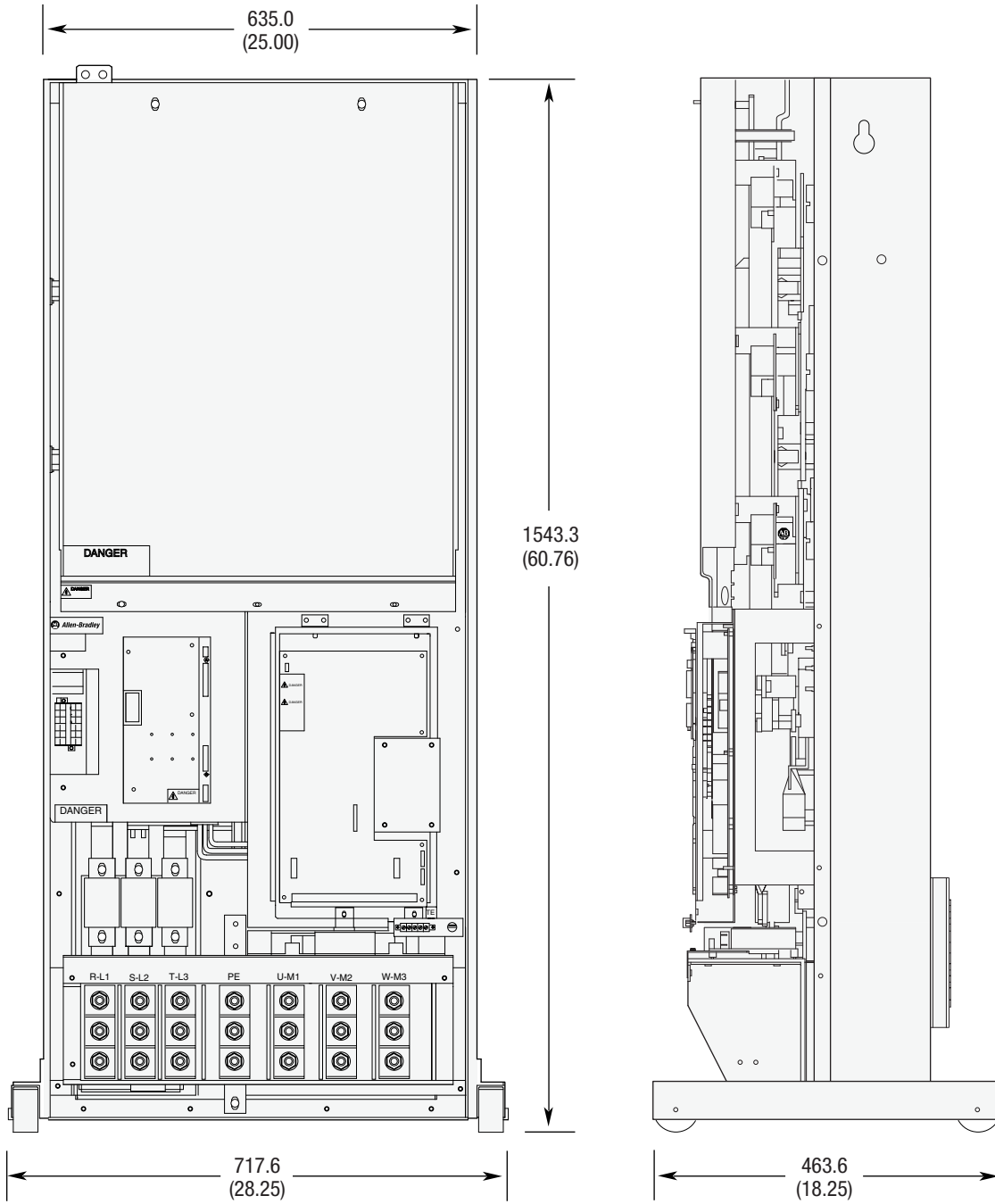

IP 20 (NEMA Type 1) & Open Dimensions – Frame G

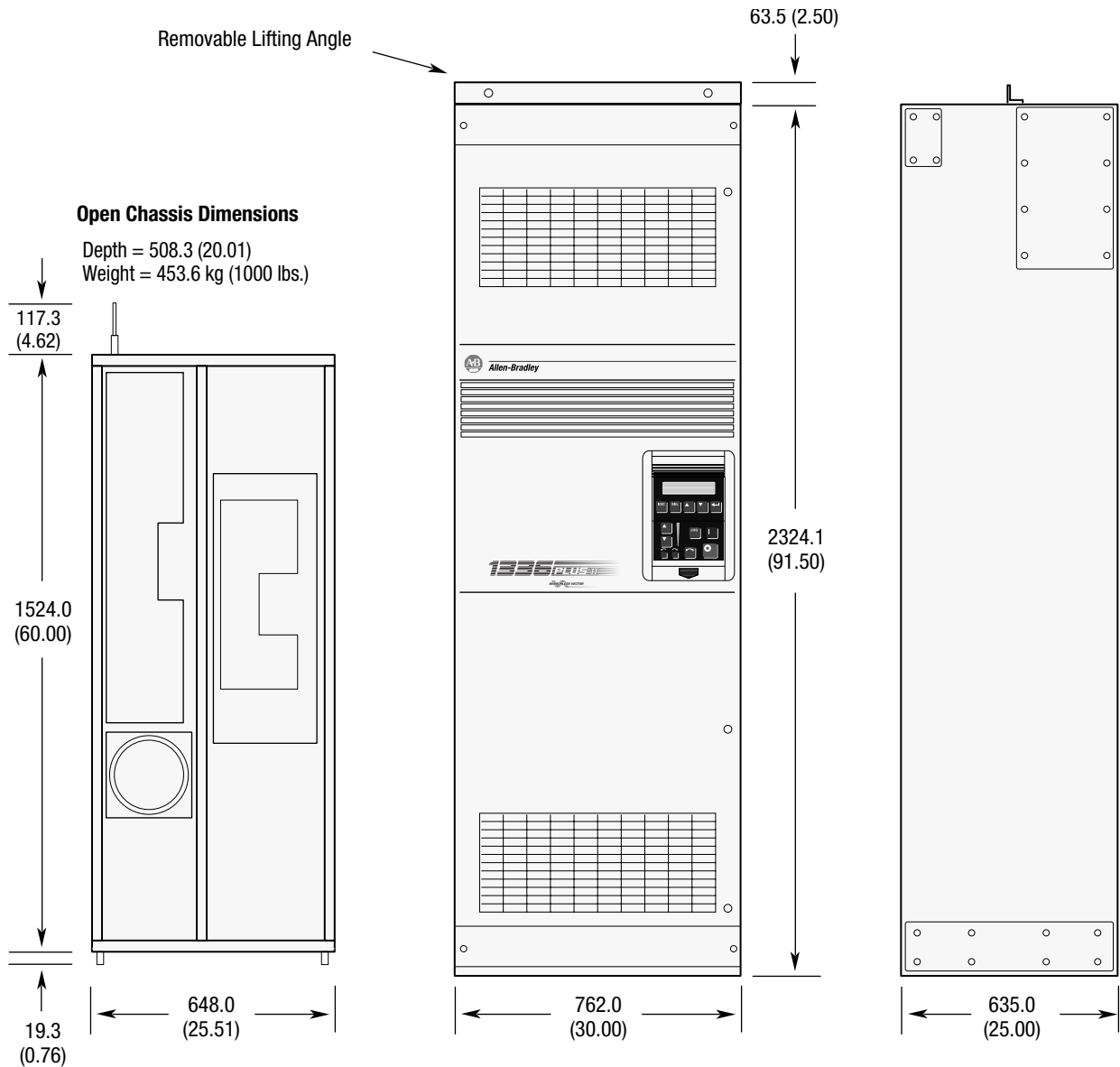

Important: Two (2) 725 CFM fans are required if an open type drive is mounted in a user supplied enclosure.

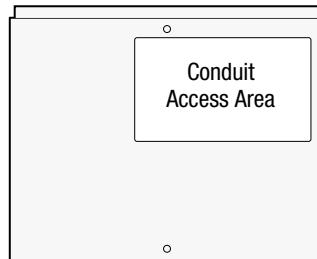

All Dimensions in Millimeters and (Inches)

See Bottom View Dimensions for Details

Pre-Installation

IP 65/54 (NEMA Type 4/12) Dimensions

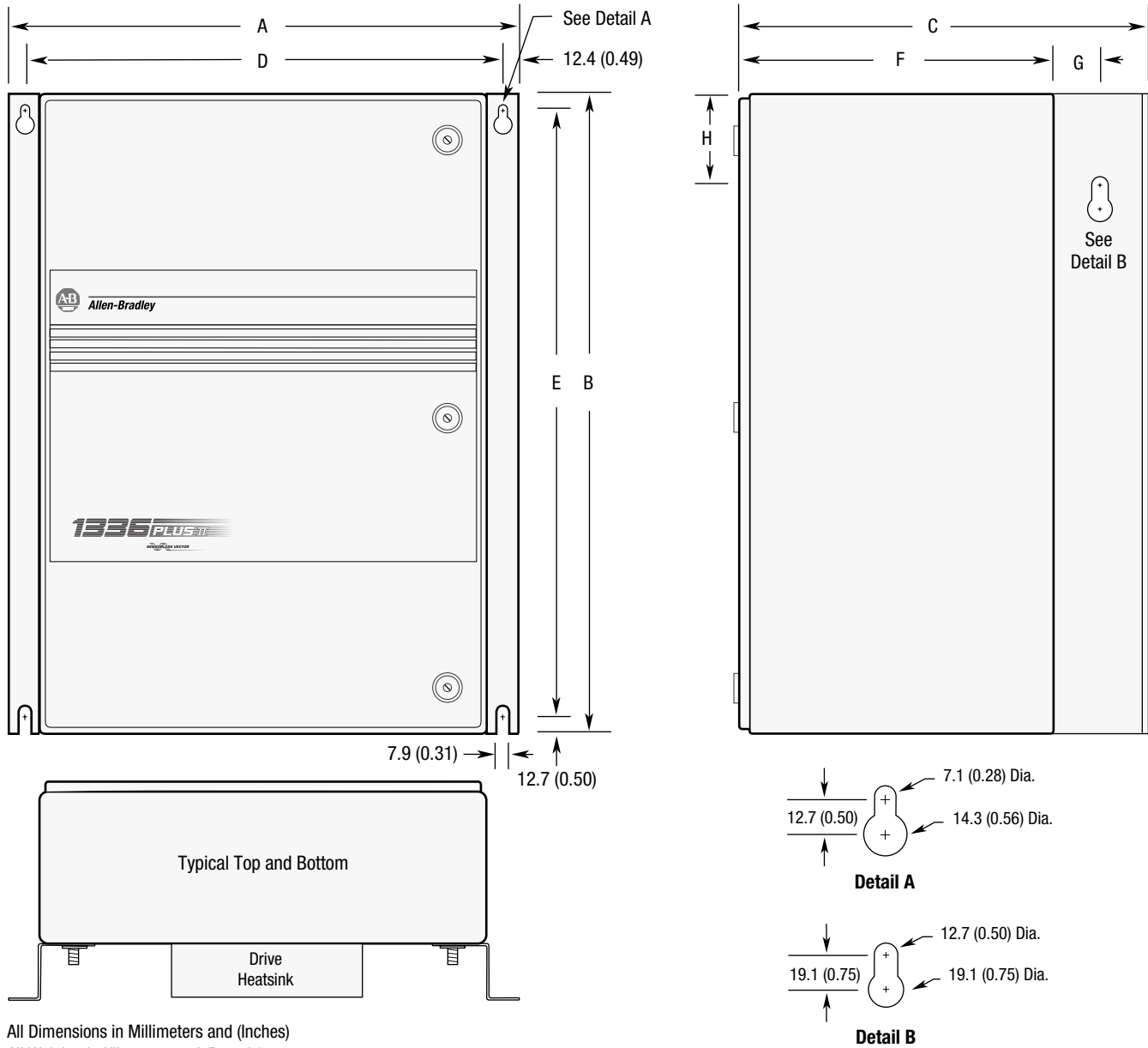

All Dimensions in Millimeters and (Inches)
 All Weights in Kilograms and (Pounds)

Frame Reference	A	B	C	D	E	F	G	H	Approx. Ship Weight
A1	430.0 (16.93)	525.0 (20.67)	350.0 (13.78)	404.9 (15.94)	500.1 (19.69)	250.0 (9.84)	N/A	N/A	16.8 (37.0)
A2	430.0 (16.93)	525.0 (20.67)	350.0 (13.78)	404.9 (15.94)	500.1 (19.69)	250.0 (9.84)	N/A	N/A	17.9 (39.4)
A3	430.0 (16.93)	525.0 (20.67)	350.0 (13.78)	404.9 (15.94)	500.1 (19.69)	250.0 (9.84)	N/A	N/A	18.6 (41.0)
A4	655.0 (25.79)	650.0 (25.59)	425.0 (16.74)	629.9 (24.80)	625.1 (24.61)	293.0 (11.54)	63.5 (2.50)	76.2 (3.00)	39.5 (87.0)
B1 5.5 kW (7.5 HP) at 200-240V AC 11 kW (15 HP) at 380-480V AC	655.0 (25.79)	650.0 (25.59)	425.0 (16.74)	629.9 (24.80)	625.1 (24.61)	293.0 (11.54)	63.5 (2.50)	76.2 (3.00)	44.7 (98.5)
B2 7.5-11 kW (10-15 HP) at 200-240V AC 15-22 kW (20-30 HP) at 380-480V AC	655.0 (25.79)	900.0 (35.43)	425.0 (16.74)	629.9 (24.80)	875.0 (34.45)	293.0 (11.54)	63.5 (2.50)	76.2 (3.00)	56.5 (124.5)
C	655.0 (25.79)	1200.0 (47.24)	425.0 (16.74)	629.9 (24.80)	1174.5 (46.22)	293.0 (11.54)	63.5 (2.50)	76.2 (3.00)	80.7 (178.0)

IP 20 (NEMA Type 1) Bottom View Dimensions – Frames A-C

Frames A1 through A4

Fans are present on these drives

Input Voltage	Frame	Catalog Number	kW/HP Rating
230	A4	F75	5.5 (7.5)
460	A4	F75	5.5 (7.5)
		F100	7.5 (10)
		F150	11 (15)
		F200	15 (20)
575	A4	F30	2.2 (3)
		F50	3.7 (5)
		F75	5.5 (7.5)
		F100	7.5 (10)
		F150	11 (15)
		F200	15 (20)

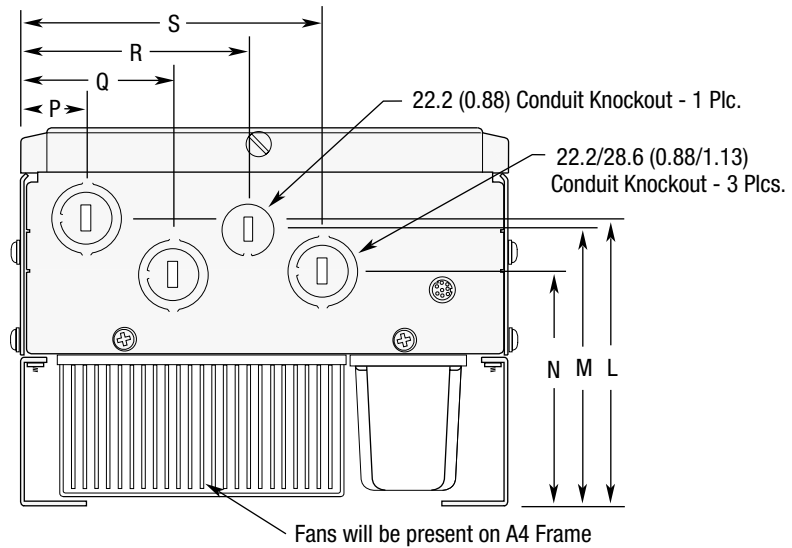

Frame Reference	L	M	N	P	Q	R	S
A1	111.8 (4.40)	105.4 (4.15)	86.3 (3.40)	31.0 (1.22)	69.1 (2.72)	102.1 (4.02)	135.4 (5.33)
A2	132.3 (5.21)	126.0 (4.96)	106.9 (4.21)	31.0 (1.22)	69.1 (2.72)	102.1 (4.02)	135.4 (5.33)
A3	158.8 (6.25)	152.4 (6.00)	133.4 (5.25)	31.0 (1.22)	69.1 (2.72)	102.1 (4.02)	135.4 (5.33)
A4	164.0 (6.45)	164.0 (6.45)	139.0 (5.47)	27.0 (1.06)	65.0 (2.56)	97.0 (3.82)	128.7 (5.07)

Frames B and C

All Dimensions in Millimeters and (Inches)

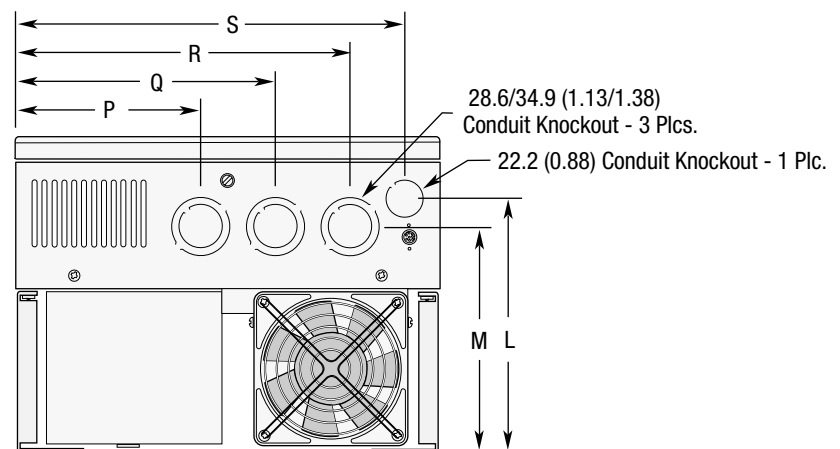

Frame Reference	L	M	P	Q	R	S
B1/B2	181.6 (7.15)	167.1 (6.58)	112.8 (4.44)	163.6 (6.44)	214.4 (8.44)	249.9 (9.84)
C	181.6 (7.15)	167.1 (6.58)	119.1 (4.69)	182.6 (7.19)	233.4 (9.19)	275.3 (10.84)

Pre-Installation

IP 20 (NEMA Type 1) Bottom View Dimensions – Frames D-G

All Dimensions in Millimeters and (Inches)

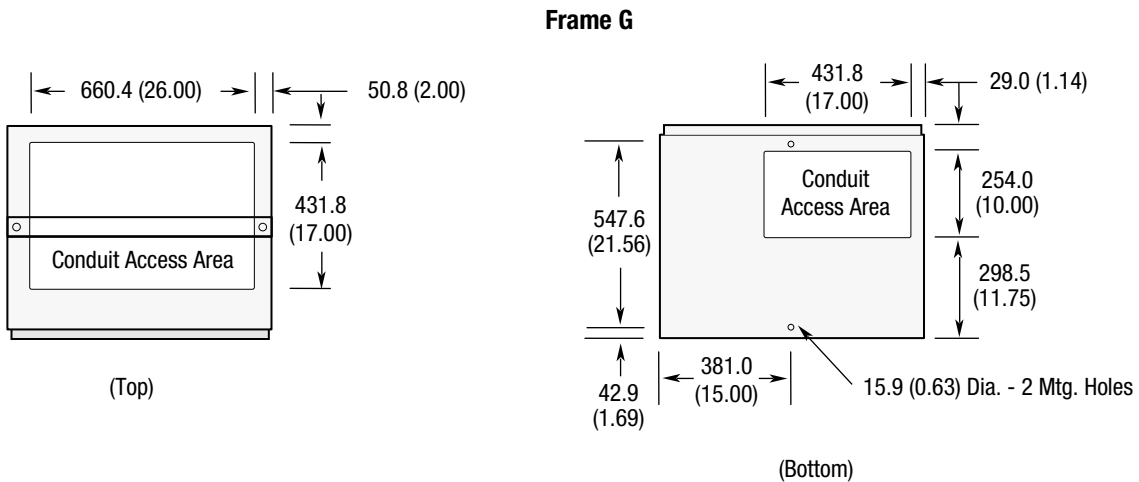
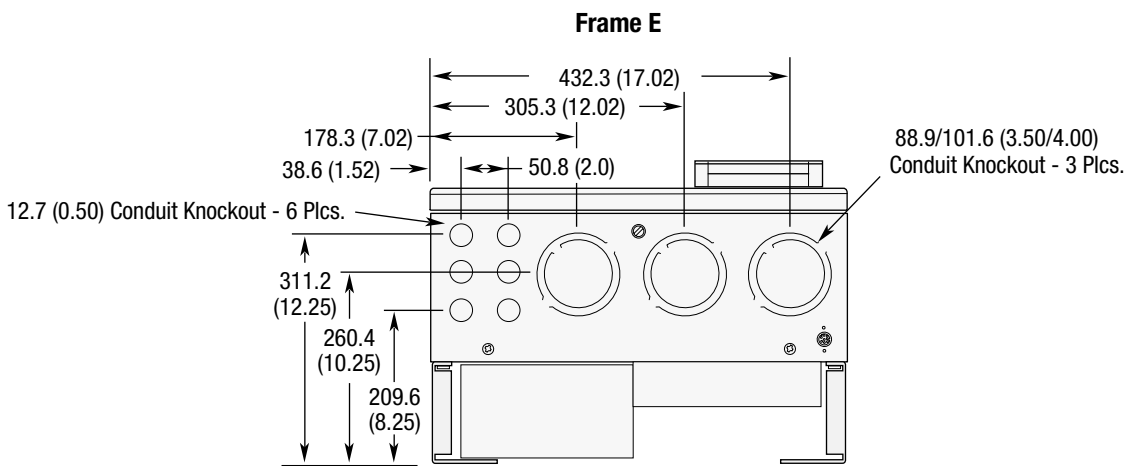
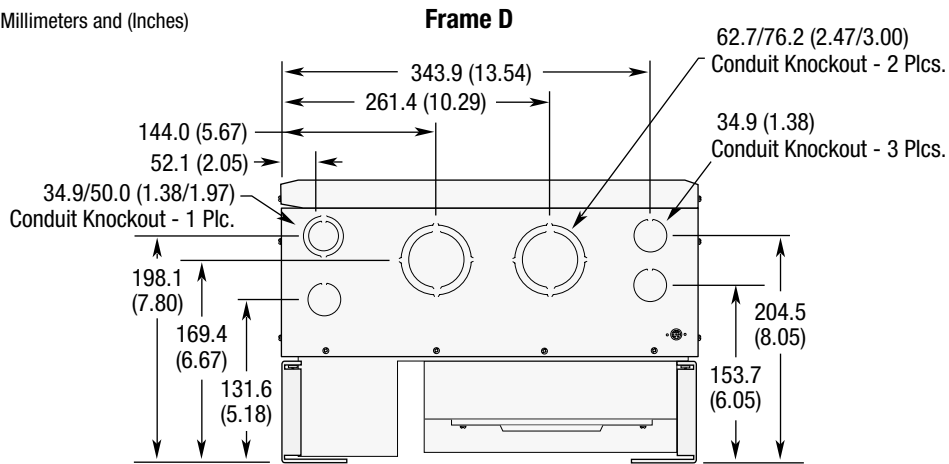

Mounting Requirements

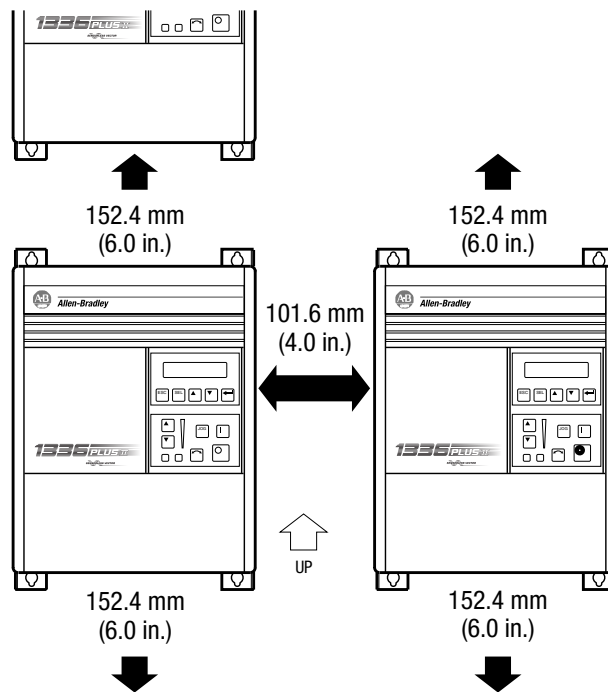

NOTE: F Frame drives require 152.4 mm (6.0 in.) on the sides and/or back for proper air flow.

Input Power Conditioning

In general, the 1336 PLUS II is suitable for direct connection to a correct voltage AC line that has a minimum impedance of 1% (3% for 0.37-22 kW/0.5-30 HP drives) relative to the rated drive input kVA. If the line has a lower impedance, a line reactor or isolation transformer must be added before the drive to increase line impedance. If the line impedance is too low, transient voltage spikes or interruptions can create excessive current spikes that will cause nuisance input fuse blowing, overvoltage faults and may cause damage to the drive power structure.

The basic rules for determining if a line reactor or isolation transformer is required are as follows:

1. If the AC input power system does not have a neutral or one phase referenced to ground (see *Unbalanced Distribution Systems* on next page), an isolation transformer with the neutral of the secondary grounded is **highly recommended**. If the line-to-ground voltages on any phase can exceed 125% of the nominal line-to-line voltage, an isolation transformer with the neutral of the secondary grounded, is **highly recommended**.
2. If the AC line supplying the drive has power factor correction capacitors that are switched in and out, an isolation transformer or 5% reactors are recommended between the drive and capacitors. If the capacitors are permanently connected and not switched, the general rules for impedance mismatch (see above) apply.
3. If the AC line frequently experiences transient power interruptions or significant voltage spikes, an isolation transformer or 5% reactors are recommended.

Refer to *Unbalanced Distribution Systems* on next page.

Pre-Installation

AC Supply Source

1336 PLUS II drives are suitable for use on a circuit capable of delivering up to a maximum of 200,000 rms symmetrical amperes, 600 volts maximum when used with the AC input line fuses specified on Page 37.



ATTENTION: To guard against personal injury and/or equipment damage caused by improper fusing, use only the recommended line fuses specified on Page 37.

Unbalanced Distribution Systems

This drive is designed to operate on three-phase supply systems whose line voltages are symmetrical. Surge suppression devices are included to protect the drive from lightning induced overvoltages between line and ground. Where the potential exists for abnormally high phase-to-ground voltages (in excess of 125% of nominal), or where the supply ground is tied to another system or equipment that could cause the ground potential to vary with operation, suitable isolation is required for the drive. Where this potential exists, an isolation transformer is strongly recommended.

Ungrounded Distribution Systems

All 1336 PLUS II drives are equipped with an MOV (Metal Oxide Varistor) that provides voltage surge protection and phase-to-phase plus phase-to-ground protection which is designed to meet IEEE 587. The MOV circuit is designed for surge suppression only (transient line protection), not continuous operation.

With ungrounded distribution systems, the phase-to-ground MOV connection could become a continuous current path to ground. Energy ratings are listed below. Exceeding published line-to-line and line-to-ground energy ratings may cause physical damage to the MOV.

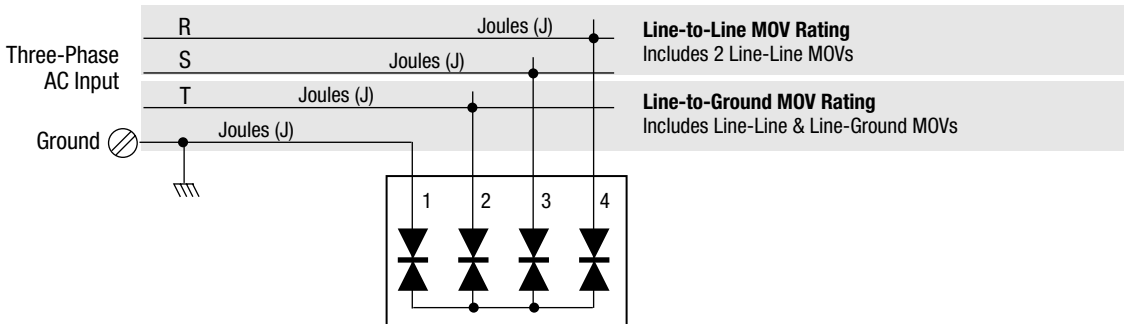

Frame Reference	A		B-C		D-G	
Device Rating (V AC)	240	480/600	240/480	600	240/480	600
Line-Line Total	160J	320J	280J	320J	280J	300J
Line-Ground Total	220J	380J	360J	410J	360J	370J

Input Fuses and Circuit Breakers

1336 PLUS II can be installed with either input fuses or an input circuit breaker. Local/national electrical codes may determine additional requirements for these installations.

Installations Per U.S. NEC/UL/CSA

Fuses

In general, the specified fuses are suitable for branch short circuit protection and provide excellent short circuit protection for the drive. The fuses offer a high interrupting capacity and are fast acting. Refer to the North American selections in the table on page **37**.

Circuit Breakers

The Westinghouse HMCP breakers specified in the table on pages **34-35** also provide branch short circuit protection. Because circuit breakers are typically slower than fuses and those listed are magnetic trip only, they may not be as effective in offering short circuit protection to the drive in the event of an internal drive short circuit. They may not be as effective in limiting damage to the drive.

IEC Installations

Fuses

For those installations that are not required to meet the U.S. NEC/UL/CSA, the specified fuses are suitable for branch short circuit protection and provide excellent short circuit protection for the drive. The fuses offer a high interrupting capacity and are fast acting. Refer to the European selections in the table on page **37**.

Circuit Breakers

For those installations that are not required to meet the U.S. NEC/UL/CSA requirements, additional devices are available as input circuit breakers. The Bulletin 140 and KTA3 devices meet the circuit breaker requirements of IEC947-2, but do not meet UL/CSA circuit breaker requirements. They can be used in "non-U.S." installations where local/national codes allow, if they are installed per their installation instructions.



ATTENTION: The 1336 PLUS II does not provide input power short circuit protection. Specifications for the recommended fuse or circuit breaker to provide drive input power protection against short circuits are provided.

Pre-Installation

Recommended Protection Devices (user supplied)

240 Volt Input																	
Frame	Drive Catalog Number	HP	Input Rating		Output Rating		Dual-Element Time Delay Fuse		Non-Time Delay Fuse		Circuit Breaker ²		Motor Circuit Protector ¹		140M Motor Starter with Adjustable Current Range ^{5,6}		
			Amps	Amps	Min. ¹	Max. ²	Min. ¹	Max. ²	Amps	Amps	Amps	Amps	Available Catalog Numbers ⁷				
A1	F05	0.5	2.8	2.3	4	5	4	6	15	3	140M-C2E-B40	140M-D8E-B40	—	—	—	—	
	F07	0.75	3.5	3.0	4	6	4	9	15	7	140M-C2E-B40	140M-D8E-B40	—	—	—	—	
	F10	1	5.4	4.5	6	9	6	12	15	7	140M-C2E-B63	140M-D8E-B63	—	—	—	—	
A2	F15	1.5	7.3	6.0	8	12.5	8	15	20	15	140M-C2E-C10	140M-D8E-C10	140M-F8E-C10	—	—	—	
	F20	2	9.7	8.0	10	15	10	20	25	15	140M-C2E-C10	140M-D8E-C10	140M-F8E-C10	—	—	—	
A3	F30	3	14.3	12.0	15	20	15	25	35	15	140M-C2E-C16	140M-D8E-C16	140M-F8E-C16	—	—	—	
	F50	5	21.3	18.0	25	30	25	45	60	30	140M-C2E-C25	140M-D8E-C25	140M-F8E-C25	140M-CMN-2500	—	—	
	F75	7.5	22.6	22.0	30	45	30	60	80	50	140M-C2E-C25	140M-D8E-C25	140M-F8E-C25	140M-CMN-2500	—	—	
B	007	7.5	28.0	27.0	40	45	40	60	80	80	50	—	—	140M-F8E-C32	140M-CMN-4000	—	—
	010	10	35.0	34.0	50	60	50	80	100	50	—	—	—	—	140M-CMN-4000	—	
	015	15	49.0	48.0	70	90	70	110	150	70	—	—	—	—	140M-CMN-6300	—	
C	020	20	63.0	65.0	100	110	100	125	200	100	—	—	—	—	140M-CMN-9000	—	
	025	25	75.0	77.0	100	150	100	200	250	100	—	—	—	—	140M-CMN-9000	—	
	030	30	79.0	80.0	125	175	125	225	300	150	—	—	—	—	140M-CMN-9000	—	
D	040	40	119.0	120.0	120	225	120	300	300	150	—	—	—	—	—	—	
	050	50	149.0	150.0	200	250	200	350	350	250	—	—	—	—	—	—	
	060	60	178.0	180.0	250	300	250	450	450	250	—	—	—	—	—	—	
E	075	75	238.0	240.0	300	400	300	500	500	250	—	—	—	—	—	—	
	100	100	289.0	291.0	400	500	400	700	700	400	—	—	—	—	—	—	
	125	125	322.0	325.0	450	700	450	800	800	600	—	—	—	—	—	—	

480 Volt Input																			
Frame	Drive Catalog Number	CT Ratings			VT Ratings			Dual Element Time Delay Fuse		Non-Time Delay Fuse		Circuit Breaker 3		Circuit Protector 4		140M Motor Starter with Adjustable Current Range ^{5,6}			
		HP	Amps	Amps	HP	Amps	Amps	Min. ¹	Max. ²	Min. ¹	Max. ²	Amps	Amps	Amps	Amps	Available Catalog Numbers - 140 . . . 7			
A1	F05	0.5	1.3	1.1	0.5	1.4	1.2	3	2.5	3	3	15	3	3	M-C2E-B16	—	—	—	
	F07	0.75	2.0	1.6	0.75	2.1	1.7	3	3	3	6	15	3	6	M-C2E-B25	—	—	—	
	F10	1	2.6	2.1	1	2.8	2.3	3	4.5	3	8	15	3	8	M-C2E-B40	M-D8E-B40	—	—	
	F15	1.5	3.3	2.8	1.5	3.5	3.0	4	6	4	12	15	7	12	M-C2E-B40	M-D8E-B40	—	—	
A2	F20	2	4.6	3.8	2	4.8	4.0	5	6	5	12	15	7	12	M-C2E-C63	M-D8E-C63	—	—	
	F30	3	6.4	5.3	3	7.2	6.0	8	10	8	15	25	7	15	M-C2E-C10	M-D8E-C10	M-F8E-C10	—	
A3	F50	5	10.0	8.4	5	10.7	9.0	12	15	12	30	35	15	30	M-C2E-C16	M-D8E-C16	M-F8E-C16	—	
A4	F75	7.5	13.6	13.3	10	15.7	15.4	20	30	20	50	50	30	50	M-C2E-C16	M-D8E-C16	M-F8E-C16	—	
	F100	10	16.4	16.1	15	22.4	22.0	30	40	30	80	80	30	80	M-C2E-C25	M-D8E-C25	M-F8E-C25	-CMN-2500	
	F150	15	24.5	24.0	20	24.5	24.0	35	60	35	100	100	50	100	M-C2E-C25	M-D8E-C25	M-F8E-C25	-CMN-2500	
	F200	20	28.0	27.0	20	28.0	27.0	35	60	35	100	100	50	—	—	M-F8E-C32	-CMN-4000	—	
B	015	15	25.0	24.2	20	28.0	27.0	35	60	35	100	100	50	—	—	M-F8E-C32	-CMN-4000	—	
	020	20	32.0	31.0	25	35.0	34.0	45	70	45	125	125	50	—	—	M-F8E-C45	-CMN-4000	—	
	025	25	40.0	39.0	30	43.0	42.0	60	90	60	150	150	70	—	—	M-F8E-C45	-CMN-6300	—	
	030	30	46.0	45.0	30	49.0	48.0	70	90	70	150	150	70	—	—	—	-CMN-6300	—	
C	X040	40	61.0	59.0	40	61.0	59.0	80	110	80	200	200	70	—	—	—	—	-CMN-6300	
	040	40	58.0	60.0	50	63.0	65.0	80	125	80	250	250	100	—	—	—	—	-CMN-6300	
	050	50	73.0	75.0	60	75.0	77.0	100	150	100	300	300	100	—	—	—	—	-CMN-9000	
	X060	60	75.0	77.0	60	75.0	77.0	100	150	100	300	300	100	—	—	—	—	-CMN-9000	
	060	60	82.0	85.0	75	93.0	96.0	125	200	125	350	350	150	—	—	—	—	—	
	075	75	105.0	106.0	100	119.0	120.0	150	250	150	450	450	250	—	—	—	—	—	
D	100	100	137.0	138.0	125	149.0	150.0	200	350	200	600	600	450	250	—	—	—	—	—
	125	125	172.0	173.0	150	178.0	180.0	250	400	250	600	600	500	250	—	—	—	—	—
	X150	150	178.0	180.0	150	178.0	180.0	250	400	250	600	600	500	250	—	—	—	—	—
	150	150	197.0	199.0	200	238.0	240.0	300	500	300	700	700	400	—	—	—	—	—	—
	200	200	261.0	263.0	250	290.0	292.0	400	600	400	800	800	400	—	—	—	—	—	—
E	250	250	322.0	325.0	250	322.0	325.0	450	600	450	800	800	400	—	—	—	—	—	—
	P250	250	322.0	325.0	300	357.0	360.0	450	—	—	—	—	—	Semiconductor fuse supplied with drive. Refer to the 1336 Spare Parts list (publication 1336-6.5) for replacement information.					
	P300	300	357.0	360.0	350	421.0	425.0	500	—	—	—	—							
	P350	350	421.0	425.0	400	471.0	475.0	600	—	—	—	—							
	P400	400	471.0	475.0	450	527.0	532.0	600	—	—	—	—							
P450	450	527.0	532.0	—	—	—	700	—	—	—	—								
G	X250	250	322.0	325.0	300	357.0	360.0	450	—	—	—	—	Bussmann Type FWP, SPP, or 170M Series Ferraz Shawmut Type A-70Q, A-70QS or A070URD Series						
	300	300	357.0	360.0	350	421.0	425.0	500	—	—	—	—							
	350	350	421.0	425.0	400	471.0	475.0	500	—	—	—	—							
	400	400	471.0	475.0	450	521.0	525.0	600/630	—	—	—	—							
	450	450	521.0	525.0	500	585.0	590.0	800	—	—	—	—							
	500	500	585.0	590.0	600	664.0	670.0	800	—	—	—	—							
	600	600	664.0	670.0	600	664.0	670.0	900	—	—	—	—							

Recommended Protection Devices (user supplied)

575 Volt Input														
Frame	Drive Catalog Number 1336F-	CT Ratings			Dual Element Time Delay Fuse		Non-Time Delay Fuse		Circuit Breaker 3	Circuit Protector 4	140M Motor Starter with Adjustable Current Range ^{5,6}			
		HP	Input Amps	Output Amps	Min. ¹	Max. ²	Min. ¹	Max. ²	Amps	Amps	Available Catalog Numbers ⁷			
A4	F10	1	2.4	2.0	3	3	3	6	15	3	140M-C2E-B25	–	–	–
	F20	2	4.8	4.0	6	6	6	10	15	7	140M-C2E-C63	140M-D8E-C63	–	–
	F30	3	7.2	6.0	10	12	10	15	15	7	140M-C2E-C10	140M-D8E-C10	140M-F8E-C10	–
	F50	5	9.6	8.0	15	20	15	20	20	15	140M-C2E-C10	140M-D8E-C10	140M-F8E-C10	–
	F75	7.5	10.0	10.0	15	20	15	30	35	15	140M-C2E-C10	140M-D8E-C10	140M-F8E-C10	–
	F100	10	12.0	12.0	20	25	20	40	40	15	140M-C2E-C16	140M-D8E-C16	140M-F8E-C16	–
	F150	15	19.0	19.0	25	35	25	60	60	30	140M-C2E-C20	140M-D8E-C20	140M-F8E-C20	140-CMN-2500
	F200	20	25.0	24.0	30	45	30	80	80	30	140M-C2E-C25	140M-D8E-C25	140M-F8E-C25	140-CMN-2500
C	025	25	31.0	30.0	40	60	40	100	100	50	–	–	140M-F8E-C32	140-CMN-4000
	030	30	36.0	35.0	50	70	50	125	125	50	–	–	140M-F8E-C45	140-CMN-4000
	040	40	44.0	45.0	60	90	60	150	150	70	–	–	140M-F8E-C45	140-CMN-6300
	050	50	55.0	57.0	80	110	80	200	200	70	–	–	–	140M-CMN-6300
	060	60	60.0	62.0	90	125	90	225	225	100	–	–	–	140M-CMN-6300
	075	75	84.0	85.0	110	150	110	300	300	100	–	–	–	140M-CMN-9000
D	100	100	108.0	109.0	150	200	150	350	350	150	–	–	–	–
	125	125	137.0	138.0	175	250	175	500	350	250	–	–	–	–
	150	150	167.0	168.0	225	300	225	500	400	250	–	–	–	–
E	200	200	251.0	252.0	350	400	350	600	500	250	–	–	–	–
	250	250	282.0	284.0	400	500	400	700	700	400	–	–	–	–
	X300	300	295.0	298.0	400	600	400	800	800	400	–	–	–	–
											–	–	–	–
F	P350	350	347.0	350.0	450						Semiconductor fuse supplied with drive.			
	P400	400	397.0	400.0	500						Refer to the 1336 Spare Parts list (publication 1336-6.5) for replacement information.			
G	300	300	297.0	300.0	400						Bussmann Type FWP, SPP, or 170M Series Ferraz Shawmut Type A-70Q, A-70QS or A070URD Series			
	350	350	347.0	350.0	450									
	400	400	397.0	400.0	500									
	450	450	446.0	450.0	600/630									
	500	500	496.0	500.0	800									
	600	600	595.0	600.0	800									

- Minimum protection device size is the lowest rated device that supplies maximum protection without nuisance tripping.
- Maximum protection device size is the highest rated device that supplies drive protection.
- Circuit Breaker - inverse time breaker.
- Motor Circuit Protector - instantaneous trip circuit breaker.
- Bulletin 140M with adjustable current range should have the current trip set to the minimum range that the device will not trip.
- Manual Self-Protected (Type E) Combination Motor Controller, UL listed for 208 Wye or Delta, 240 Wye or Delta, 480Y/277 or 600Y/ 347. Not UL listed for use on 480V or 600V Delta/Delta systems.
- The AIC ratings of the Bulletin 140M Motor Protector may vary. See publication 140M-SG001B-EN-P.

Pre-Installation

Power Wiring – TB1

Input and output power connections are performed through terminal block, TB1.
For maintenance and setup procedures, the drive may be operated without a motor connected.





ATTENTION: An incorrectly applied or installed bypass system can result in component damage or reduction in product life. The most common causes are:

- Wiring AC line to drive output or control terminals.
- Improper bypass or output circuits not approved by Allen-Bradley.
- Output circuits which do not connect directly to the motor.

Contact Allen-Bradley for assistance with application or wiring.

TB1 SIGNALS

Terminal	Description
PE 	Potential Earth Ground
TE 	Shield Termination - True Earth
R (L1), S (L2), T (L3)	AC Line Input Terminals
+DC, -DC	DC Bus Terminals
U (T1), V (T2), W (T3)	Motor Connection

TB1 SPECIFICATIONS – USE 75° C RATED COPPER WIRE ONLY

Terminal Block Type	Max./Min. Wire Size ¹ mm ² (AWG)	Maximum Torque N-m (lb.-in.)
A1-A4 (Page 50)	5.3/0.8 (10/18)	1.81 (16)
B1 (Page 50)	8.4/0.8 (8/18)	1.81 (16)
B2 (Page 50)	13.3/0.5 (6/20)	1.70 (15)
C (Page 50)	26.7/0.8 (3/18)	5.65 (50)
D (Page 51) ³	127.0/2.1 (250 MCM / 14) 67.4/2.1 (00/14) ²	6.00 (52) 6.00 (52)
E (Page 51) ³	253.0/2.1 (500 MCM/14)	10.00 (87)
F (Page 52) ³	303.6/2.1 (600 MCM/14)	23.00 (200)
G (Page 52) ³	303.6/2.1 (600 MCM/14)	23.00 (200)

¹ Wire sizes given are maximum/minimum sizes that TB1 will accept – these are not recommendations.

² Applies to 30 kW (40 HP) 200-240V, 45 & 56 kW (60 & 75 HP) 380-480V, 56 kW (75 HP) 500-600V drives only.

³ These configurations of TB1 are stud type terminations and require the use of lug type connectors to terminate the field installed conductors.

Power Wiring – TB1

A1-A3 Frame

200-240V, 0.37-3.7 kW (0.5-5 HP) Terminal Designations
 380-480V, 0.37-3.7 kW (0.5-5 HP) Terminal Designations

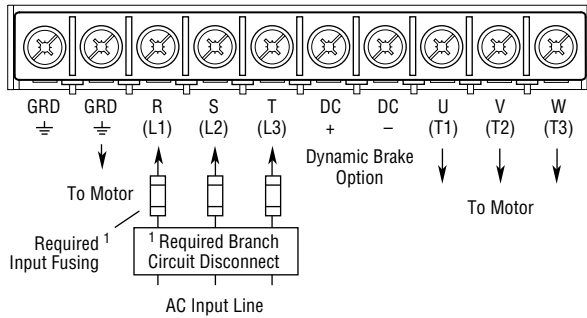

A4 Frame

380-480V, 5.5-15 kW (7.5-20 HP) Terminal Designations
 500-600V, 0.75-15 kW (1-20 HP) Terminal Designations

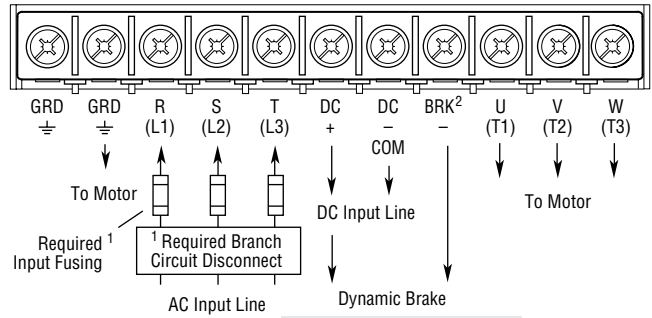

Important: A brake malfunction will occur if the Dynamic Brake is connected to "DC – COM"

B1 Frame

200-240V, 5.5 kW (7.5 HP) Terminal Designations

380-480/500-600V, 5.5-11 kW (7.5-15 HP) Terminal Designations

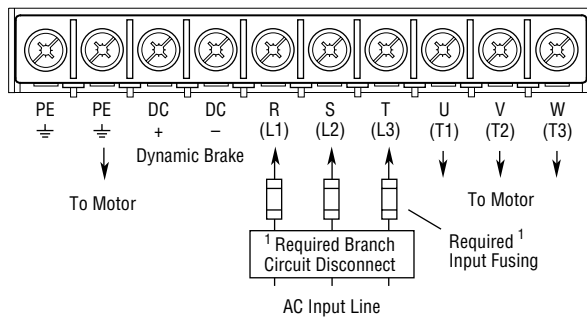

B2 Frame

200-240V, 7.5-11 kW (10-15 HP) Terminal Designations

380-480V, 15-22 kW (20-30 HP) Terminal Designations

500-600V, 15 kW (20 HP) Terminal Designations

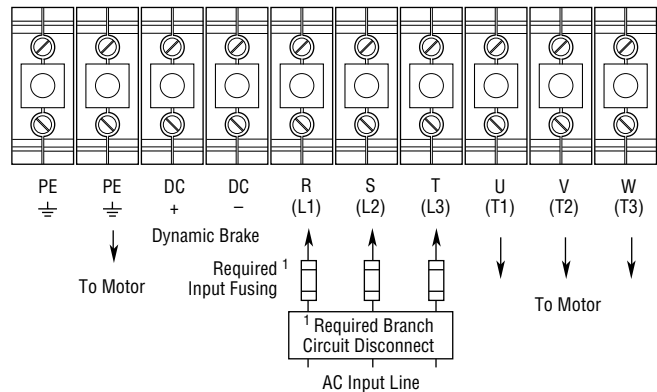

C Frame

200-240V, 15-22 kW (20-30 HP) Terminal Designations

380-480V, 30-45 kW (40-60 HP) Terminal Designations

500-600V, 18.5-45 kW (25-60 HP) Terminal Designations

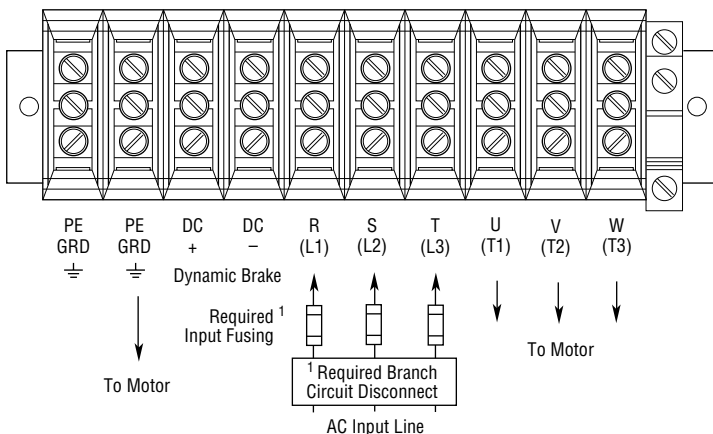

¹ User supplied.

² Terminal located separately on Series A Drives.

Pre-Installation

Power Wiring – TB1

D Frame

200-240V, 30-45 kW (40-60 HP) Terminal Designations
 380-480V, 45-112 kW (60-150 HP) Terminal Designations
 500-600V, 56-112 kW (75-150 HP) Terminal Designations

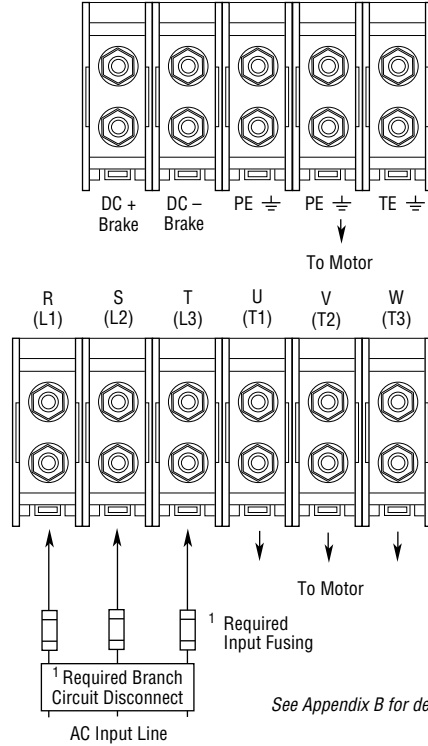

E Frame

200-240V, 56-75 kW (75-100 HP) Terminal Designations
 380-480V, 112-187 kW (150-250 HP) Terminal Designations
 500-600V, 112-224 kW (150-300 HP) Terminal Designations

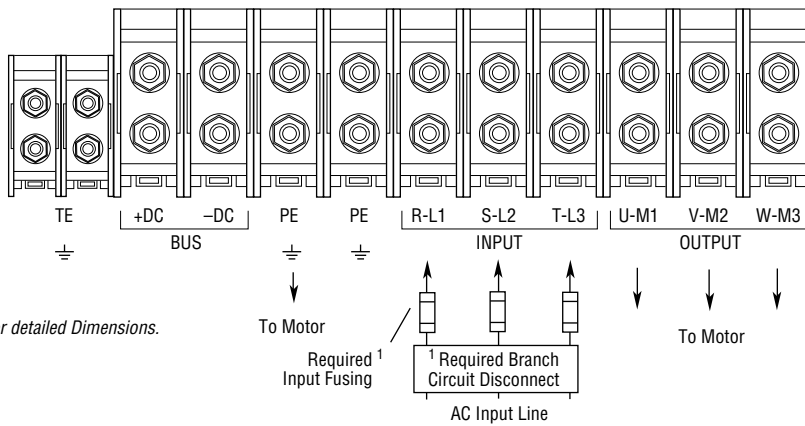

¹ User supplied.

Power Wiring – TB1

F Frame

380-480V, 187-336 kW (250-450 HP) Terminal Designations

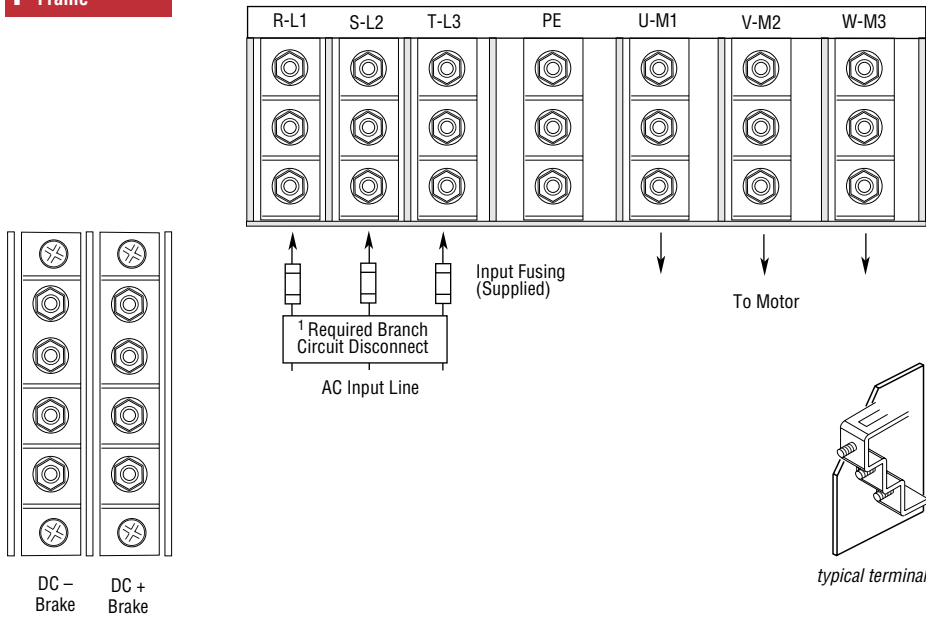

G Frame

380-480V, 224-448 kW (300-600 HP) Terminal Designations
500-600V, 187-448 kW (250-600 HP) Terminal Designations

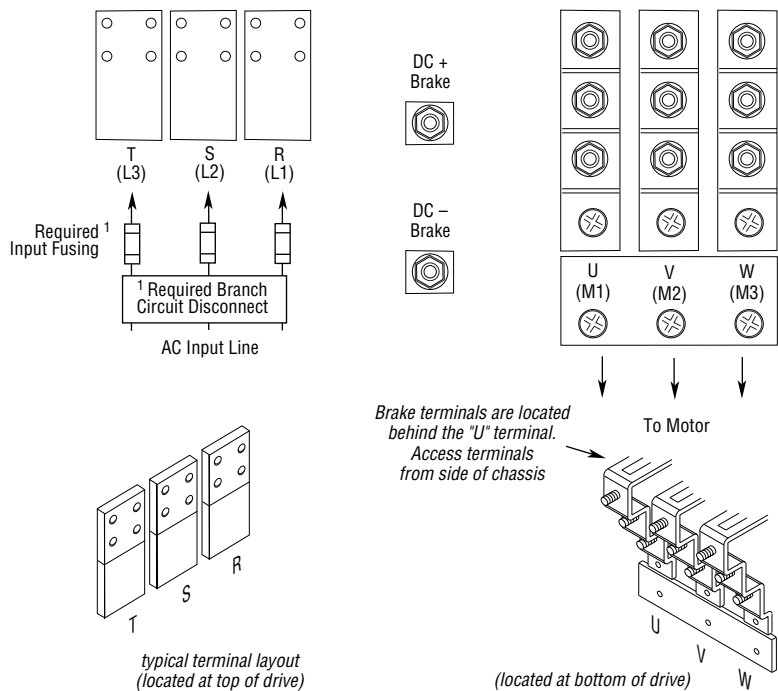

¹ User supplied.

Pre-Installation

Control and Signal Wiring

General Wiring Information

General requirements for analog signal wire include: stranded copper 0.750-0.283 mm² (18-22 AWG), twisted-pair, 100% shield with drain wire, 300V minimum insulation rating and a temperature rating suitable for the application (not less than 60 degrees C). The recommended signal (analog I/O) wire is:

- Belden 8760/9460 (or equiv.) – 0.750 mm² (18 AWG), twisted pair, shielded.
- Belden 8770 (or equiv.) – 0.750 mm² (18 AWG), 3 conductor, shielded for remote pot only.

The recommended wire for encoder inputs/outputs is:

- Lengths less than or equal to 30 meters (98 feet) Belden 9730 (or equiv.) – 0.196 mm² (24 AWG), individually shielded
- Lengths greater than 30 meters (98 feet) Belden 9773 (or equiv.) – 0.750 mm² (18 AWG), twisted pair, shielded

Signal Connections

If the drive control connections are to be linked to an electronic circuit or device, the common or 0V line should, if possible, be grounded at the device (source) end only.

Important: Signal Common – User speed reference signals are terminated to logic common at TB2, terminal 5. This puts the negative (or common) side of these signals at earth ground potential. Control schemes must be examined for possible conflicts with this type of grounding scheme.

Shield Termination – TE (True Earth)

The TE terminal block (not available on 0.37-7.5 kW (0.5-10 HP) A Frame drives) provides a terminating point for signal wiring shields.

The maximum and minimum wire size accepted by this block is 2.1 and 0.30 mm² (14 and 22 AWG). Maximum torque is 1.36 N-m (12 lb.-in.). Use Copper wire only and always separate control and power cabling.

Cable Routing

If unshielded cable is used, control signal circuits should not run parallel to motor cables or unfiltered supply cables with a spacing less than 0.3 meters (1 foot). Cable tray metal dividers or separate conduit should be used.

Important: When user-installed control and signal wiring with an insulation rating of less than 600V is used, this wiring must be routed inside the drive enclosure and separated from any other wiring and/or uninsulated live parts.

Terminal Block – TB2

TB2 is located at the bottom of the Main Control Board. 0.37-7.5 kW (0.5-10 HP) A Frame drives have 18 positions. Remaining frame sizes from 5.5 kW (7.5 HP) and up have 22 positions. The maximum and minimum wire size accepted by TB2 is 2.1 and 0.30 mm² (14 and 22 AWG). Maximum torque for all terminals is 1.36 N-m (12 lb.-in.). Use Copper wire only.

Terminal Block – TB3

The Control Interface Option provides a means of interfacing various signals and commands to the 1336 PLUS II by using contact closures. Six different versions of the option are available:

- L4 Contact Closure Interface¹
- L4E/L7E2 Contact Closure Interface¹ with Encoder Feedback Inputs
- L5 +24V AC/DC Interface
- L5E/L8E2 +24V AC/DC Interface with Encoder Feedback Inputs
- L6 115V AC Interface
- L6E/L9E2 115V AC Interface with Encoder Feedback Inputs

The user inputs are connected to the option board through TB3 (see Figure 2.1 for location). The L4, L5 and L6 options each have nine control inputs. The function of each input must be selected through programming as explained later in this section. The L4E/L7E, L5E/L8E and L6E/L9E2 options are similar to L4, L5 and L6 with the addition of encoder feedback inputs. Refer to Appendix A in Pub. 1336 PLUS – 5.3 for input impedance values.

The maximum and minimum wire size accepted by TB3 is 2.1 and 0.30mm² (14 and 22 AWG). Recommended torque for all terminals is 0.90-1.13 N-m (8-10 lb.-in.). Use Copper wire only.

Digital Inputs

Digital inputs are connected at TB3.

Input Mode Select

A number of combinations are available by first programming [Input Mode] to the desired control scheme (i.e. 2-wire, 3-wire or Status). The remaining inputs can then be configured by programming [TB3 Term 22 Sel] through [TB3 term 28 Sel]. Refer to the Digital I/O parameter group in Chapter 6 of Pub. 1336 PLUS – 5.3 for programming information.

¹ Uses internal +5V DC supply.

² The encoder loss detection feature of the 1336 PLUS II requires the use of L7E, L8E or L9E.

Pre-Installation

Digital I/O Default Settings – TB3

		Input Mode (Start/Stop Functions Only)		
		Status ² (Factory Default)	2-Wire Control Single-Source Control	3-Wire Control Single-Source Reversing
Input 1	19	Status	Run Forward	Start
Input 2	20	Stop/Fault Reset ³	Stop/Fault Reset ³	Stop/Fault Reset ³
Common	21	Status Only Default Mode shown at right is not active when [Input Mode] is set to "Status"	Individually Programmable Inputs	
Input 3	22		Rev/For ⁴ (Factory Default)	(programmable)
Input 4	23		Jog (Factory Default)	(programmable)
Input 5	24		Auxiliary ³ (Factory Default)	(programmable)
Common	25		Common	
Input 6	26		Speed Select 3 ¹ (Factory Default)	(programmable)
Input 7	27		Speed Select 2 ¹ (Factory Default)	(programmable)
Input 8	28		Speed Select 1 ¹ (Factory Default)	(programmable)
Common	29		Common	
Input 9	30		Enable ³	(not programmable)
Encoder B	31	Included on L4E/L7E, L5E/L8E & L6E/L9E ⁵		
Encoder NOT A	32			
Encoder NOT B	33			
Encoder A	34			
+12V (200mA max.)	35			
Encoder Common	36			

¹ See Speed Select Table.

² If this mode is selected, the status of all inputs can be read at the [Input Status] parameter. However, only "Stop/Fault Reset" and "Enable" will have control function.

³ These inputs must be present before drive will start.

⁴ Bit 0 of [Direction Mask] must = 1 to allow TB3 direction change.

⁵ The encoder loss detection feature of the 1336 PLUS II requires the use of L7E, L8E or L9E.



ATTENTION: Two-wire control uses maintained Run contacts that act as both Run (closed) and Stop (open) devices. Opening the Stop contact (terminal 20) will stop the drive. If this contact is reclosed, any fault will be reset. If a valid Start command is still present, the drive will restart.

If a three-wire device (i.e. HIM) is also used, pressing the HIM Stop key will also stop the drive. Releasing the Stop key will clear any faults that are present, but the drive will not restart without cycling the Start contact.

Digital I/O Default Settings – TB3

Available Functions for Inputs 3 through 8

A variety of combinations made up of the following inputs are available.

Input	Description
1st/2nd Accel 1st/2nd Decel	Closing these inputs (1st or 2nd Accel, 1st or 2nd Decel) commands the corresponding rate. If both inputs are open or both are closed, the current rate is maintained.
1st/2nd Accel/Decel	Allows selection of the accel or decel time used by the drive. 1=2nd, 0=1st
Auxiliary	Faults the drive via external devices (i.e. motor thermoswitch, O.L. relays, etc.). Opening this contact will fault (F02 - Aux Fault) the drive and shut the output off, ignoring the programmed stop mode.
Clear Fault	If drive has faulted, closing this input will clear the fault.
Digital Pot (MOP) Up/Down	These inputs increase (up) or decrease (down) the drive commanded frequency when MOP (Motor Operated Potentiometer) is chosen as the frequency command source. The rate of increase/decrease is programmable.
Forward	Closing these inputs (Forward or Reverse) commands the corresponding direction. If both inputs are open or both are closed, the current direction is maintained.
Forward/Reverse	Available only with three-wire control - Closing this input commands reverse direction and opening this input commands forward direction.
Jog	Closing this input starts the drive and causes it to run at programmed jog frequency. Opening this input stops the drive using the programmed stop mode.
Line Loss	Closing this input gives exclusive control of drive logic to the inputs at terminal block TB3. No other devices may issue logic commands (excluding Stop) to the drive.
Output Contactor Closed	Output contactor auxiliary contact indicates that the output contactor is closed.
Reverse	See "Forward" above.
PI Enable	Enables the output of the process PI loop.
PI Reset	Opening this input clamps the process PI integrator value at zero. Closing this input allows the integrator to continue to operate.
Run Reverse	Available only with two-wire control - Closing this input issues both a start command and a reverse command to the drive. Opening the input issues a stop command to the drive.
Speed Select 1, 2, 3	These inputs choose the frequency command source for the drive. See following pages for details.
Stop Type	Closing this input selects the stop mode in [Stop Select 2] as the method of stopping when a stop command is issued. Opening this input selects the stop mode in [Stop Select 1] as the method of stopping.
Sync	Normally wired to multiple drives – When the Sync input is low, the drive operates normally. When the input is high, the speed of the drive will be held constant and the speed command will have no effect. During this period the speed input of the drive will normally be changed to a different source and/or value. Allows synchronized change of frequency command to multiple drives.
Traverse	Setting this input low disables the traverse function. When the input is high, the traverse function will be active. [Speed Control] must also be set to "P Jump" for the function to be active.

Important: If a Control Interface Option is not installed, the [Input Mode] parameter must be set to "Status" (default) and jumpers must be installed. If the drive was shipped from the factory without the option, these jumpers will have been installed.

Important: The [Input Mode] and [TB3 Term 22-28 Sel] parameters can be changed at any time, but the change will not affect drive operation until power to the drive has been removed and bus voltage has decayed completely. When changing either parameter, it is important to note that the functions of the Start and Stop inputs will change when power is reapplied to the drive.

Pre-Installation

Digital I/O Default Settings – TB3

The programming options of the Control Interface Option allow the user to select an input combination to meet the needs of a specific installation. The firmware will verify programming, to assure an appropriate combination has been selected.

Speed Select/Frequency Reference

The drive speed command can be obtained from a number of different sources. The source is determined by drive programming and the condition of the Speed Select Inputs on TB3 (or reference select bits of command word if PLC controlled - Refer to Appendix A in Publication 1336 PLUS - 5.3).

The default source for a command reference (all speed select inputs open) is the selection programmed in [Freq Select 1]. If any of the speed select inputs are closed, the drive will use other parameters as the speed command source. Refer to the table below and the examples that follow.

Speed Select Input State vs. Frequency Source

Speed Select 3	Speed Select 2	Speed Select 1	Frequency Source
Open	Open	Open	[Freq Select 1]
Open	Open	Closed	[Freq Select 2]
Accessed through [Freq Select 2] parameter			[Preset Freq 1]
Open	Closed	Open	[Preset Freq 2]
Open	Closed	Closed	[Preset Freq 3]
Closed	Open	Open	[Preset Freq 4]
Closed	Open	Closed	[Preset Freq 5]
Closed	Closed	Open	[Preset Freq 6]
Closed	Closed	Closed	[Preset Freq 7]

Important: The final speed command may be affected by the type of modulation selected with [Speed Control], parameter 77.

Example

Application is to follow a local HIM unless a preset speed is selected. The drive is programmed as follows:

- [Freq Select 1] = Adapter 1
- [Freq Select 2] = Preset Freq 1
- [Preset Freq 1] = 10 Hz.
- [Preset Freq 2] = 20 Hz.
- [Preset Freq 3] = 30 Hz.

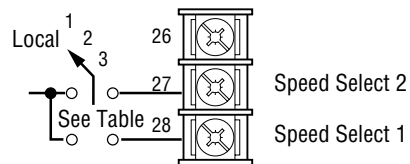

Contact operation for the speed select switch is described in the table below. If the user does not select an input as Speed Select 3, [Preset Freq 4-7] would not be available.

Switch Position	Speed Select Input		Parameter Used for Speed Ref.	Programmed Setting
	1 (#28)	2 (#27)		
Local	Open	Open	[Freq Select 1]	Adapter 1
1	Closed	Open	[Freq Select 2]	Preset Freq 1
2	Open	Closed	[Preset Freq 2]	20 Hz.
3	Closed	Closed	[Preset Freq 3]	30 Hz.

Encoder Inputs

Encoders must be line driver type, quadrature or pulse, 5V DC or 8-15V DC output, single-ended or differential and capable of supplying a minimum of 10mA per channel. Maximum input frequency is 250 kHz.

Encoder inputs are available at TB3. The interface board is jumper selectable to accept a 5V TTL or 12V DC square-wave with a minimum high state voltage of 3.0V DC (TTL) or 7.0V DC (12 volt encoder). Maximum low state voltage is 0.4V DC.

Encoder Signal Wiring

Single-Ended, Dual-Channel ¹

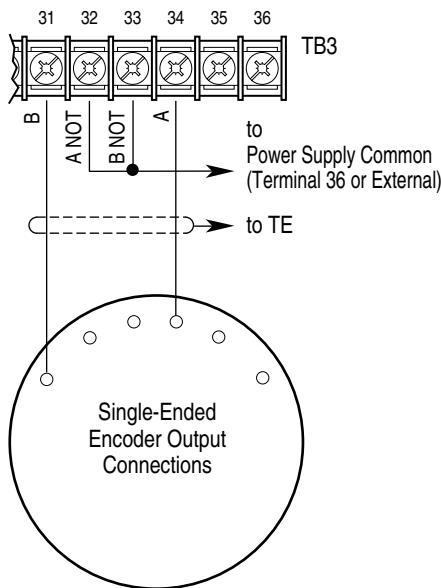

Differential

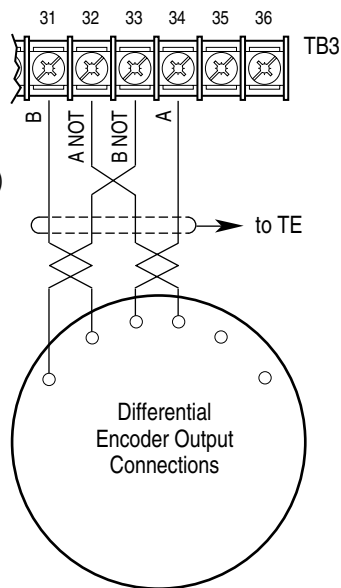

¹ For Single-Ended, Single-Channel (pulse) applications, eliminate the B and B (NOT) connections. Some encoders may label the "A" connection as "Signal."

Important: Correct direction of motor rotation as determined during start-up may require that the A or B channel wiring be reversed.

Encoder Power Wiring

Internal

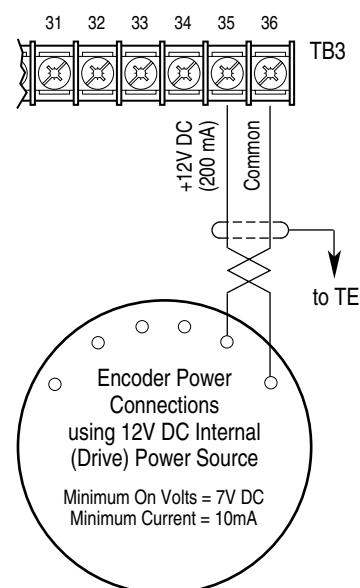

External

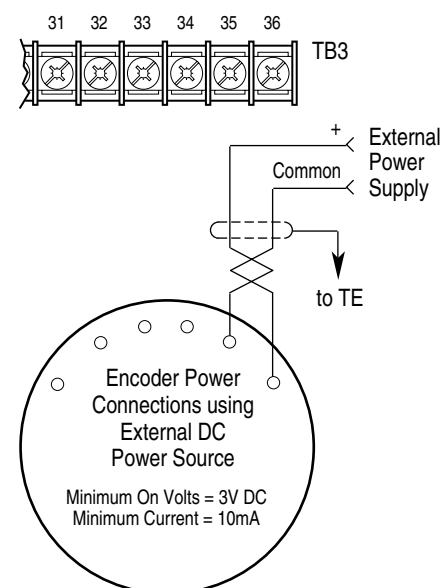

Important: Control Interface Board jumpers JP3 & JP4 must be set for the voltage level of the encoder output.

Pre-Installation

Pulse Input/Output Option

Pulse Input

The pulse input signal must be an externally powered square-wave pulse at a 5V TTL logic level. As measured at the terminal block, circuits in the high state must generate a voltage between 3.6 and 5.5V DC at 8 mA. Circuits in the low state must generate a voltage between 0.0 and 0.8V DC. Maximum input frequency is 250kHz. Scale factor [Pulse/Enc Scale] must be set.

ATTENTION: If input voltages are maintained at levels above $\pm 12V$ DC, signals may be degraded and component damage may result.

Pulse Output

Provides a TTL pulse train suitable for driving up to three 1336 PLUS II pulse inputs or a separate 125-ohm load at TTL levels (4V at 32 mA source, 0.8V at 3.2 mA sink).

The digital outputs are at terminals 10 through 18 of TB2.

Digital Outputs – TB2

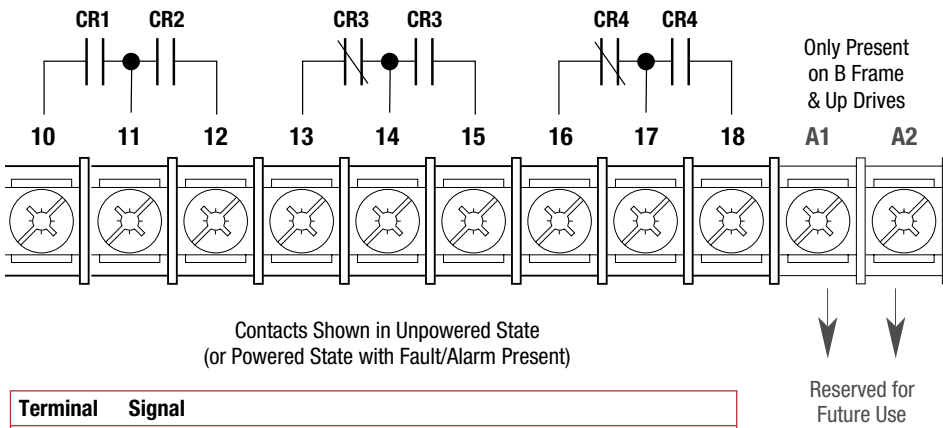

Contacts Shown in Unpowered State
(or Powered State with Fault/Alarm Present)

Terminal	Signal	
TE	True Earth - Shield Termination	
10, 11	CR1 Programmable Contact	
11, 12	CR2 Programmable Contact	
13, 14 14, 15	CR3 Programmable Contact	Resistive Rating = 115V AC/30V DC, 5.0A Inductive Rating = 115V AC/30V DC, 2.0A
16, 17 17, 18	CR4 Programmable Contact	
A1, A2	Reserved for Future Use	

Analog Inputs/Outputs

The 1336 PLUS II analog I/O configuration provides a standard set of inputs and outputs with the capability to install up to 2 option boards, thus replacing the standard I/O with a variety of options. All connections are performed at TB2. Installing an option board in the slot A or B location will change the function of those terminals on TB2 from standard. Only one option board can be installed in each slot. The standard and optional I/O configurations are shown below.

Analog I/O – TB2

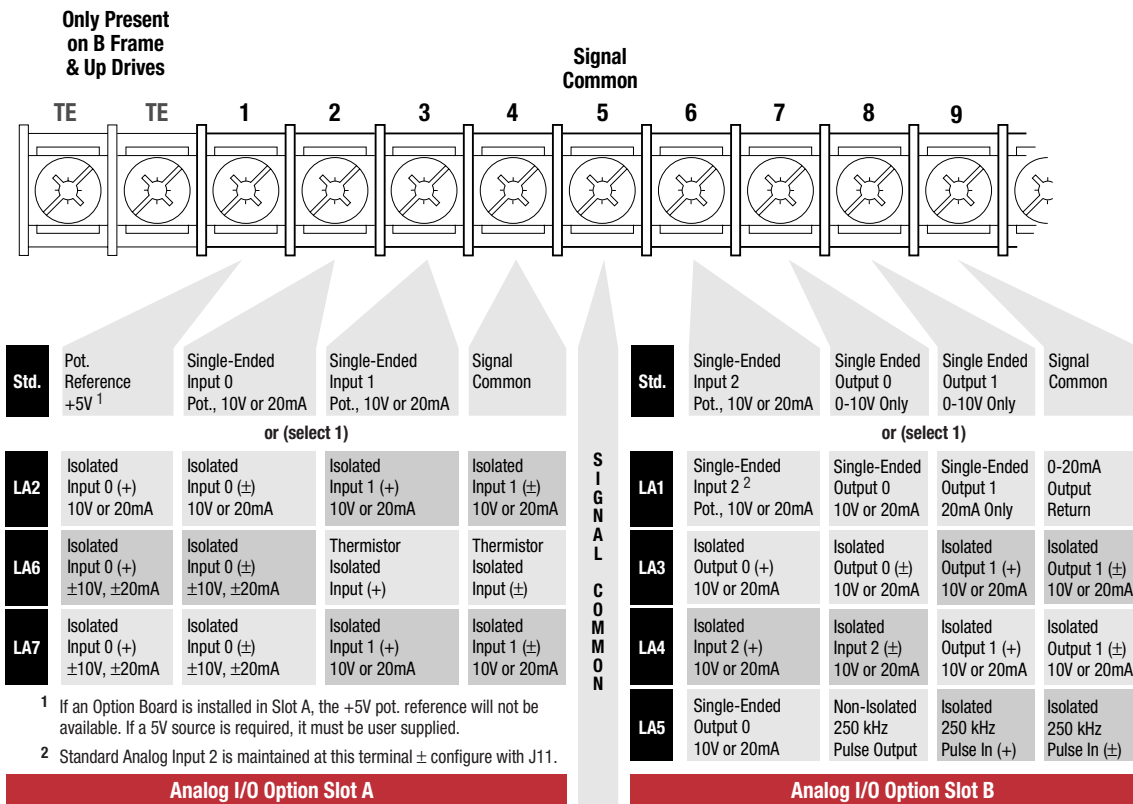

Pre-Installation

Analog Inputs/Outputs

All isolated I/O is designed with full galvanic (greater than 10 meg ohms, less than 50 pf) isolation. This results in an insulation withstand capability of 200V AC from each channel to True Earth (TE) ground and between channels. The Analog I/O Option Boards are summarized below.

Option	Board Type	Slot	Description
LA1 (LA1C)²	Dual Analog Output	B	This option replaces both standard analog outputs with two single-ended high resolution analog outputs. Analog Output 0 is configurable to 0-10V or 0-20 mA operation while Analog Output 1 is for 0-20 mA operation only. This option maintains access to the standard (non-isolated) Analog Input 2 through TB2-6 – Configuration remains with jumper J11.
LA2 (LA2C)²	Dual Isolated Input	A	This option replaces the two standard analog inputs with two galvanically isolated analog inputs. Both analog input channels are configurable for 0-10V or 0-20 mA operation.
LA3 (LA3C)²	Dual Isolated Output	B	Replaces Analog Input 2 and both standard analog outputs with two galvanically isolated high resolution analog outputs. Both analog output channels are configurable for 0-10V or 0-20 mA operation.
LA4 (LA4C)²	Isolated Input/ Isolated Output	B	This option replaces Analog Input 2 and both standard analog outputs with a galvanically isolated analog input and a galvanically isolated high resolution analog output. Both analog channels are configurable for 0-10V or 0-20 mA operation.
LA5 (LA5C)²	Analog Output/Pulse Output/Pulse Input	B	This option replaces Analog Input 2 and both standard analog outputs with a single-ended high resolution analog output, a single-ended 5V pulse output, and galvanically isolated 5V pulse input. The analog output channel is configurable for 0-10V or 0-20 mA operation.
LA6¹ (LA6C)²	Isolated Bipolar/ Isolated Thermistor Input	A	This option replaces the two standard analog inputs with a galvanically isolated analog input and a galvanically isolated thermistor input. Analog Input 0 is configurable for $\pm 10V$ or ± 20 mA operation, with polarity determining forward or reverse operation. Analog Input 0 is suitable for use with PTC sensor chains with a maximum total resistance at normal operating temperature of 1.8k ohms. An indication occurs in short circuit or over-temperature conditions. A short circuit condition is when the total resistance of the sensor chain is less than 60 ohms with reset from the short circuit condition occurring when the resistance exceeds 70 ohms. An over-temperature condition is when the total resistance of the sensor chain exceeds 3.3k ohms with reset from the over-temperature condition occurring when the resistance is less than 2.2k ohms.
LA7¹ (LA7C)²	Isolated Bipolar Input/Isolated Input	A	This option replaces the two standard analog inputs with two galvanically isolated analog inputs. Analog Input 0 is configurable for $\pm 10V$ or ± 20 mA operation, with polarity determining forward or reverse operation, while Analog Input 1 is configurable for 0-10V or 0-20 mA operation.

¹ If a bi-polar input option (LA6 or LA7) is installed, the signal is designated "Analog Input 0." Note the following:

3-Wire Control – If [Input Mode] is set to "3 Wire" and the bi-polar input is selected as the active frequency reference [Freq Select 1 or 2], it is assumed that direction control is desired via analog polarity. If another source has control of direction, a "Bipolar Direction" fault (F16) will occur. If direction control via polarity is not required, bit 7 of [Direction Mask] should be set to "0". This causes the input to be treated as a 0-10V frequency reference only. Negative analog signals are treated as zero and direction control must come from another source.

2-Wire Control – If [Input Mode] is set to "2 Wire," it is assumed that direction control is provided via the 2 wire inputs (Run Forward and Run Reverse). Bit 7 of [Direction Mask] must be set to "0". This causes the input to be treated as a 0-10V frequency reference only. Negative analog signals are treated as zero. Failure to set the Mask will generate a "Bipolar Direction" (F16) fault.

² Packaged Drives Program options which are typical of North America. Other locations should contact their local Rockwell Automation office for availability of similar product.

Standard Analog I/O Setup

The 1336 PLUS II has a series of jumpers to connect the standard I/O to TB2 when no analog options (LA1, LA2, etc.) are present. Connectors J9 and J10 (see below) each have four jumpers connecting pins 1-2, 3-4, 5-6 and 7-8. These jumpers must be in place for the inputs and outputs to be active at TB2.

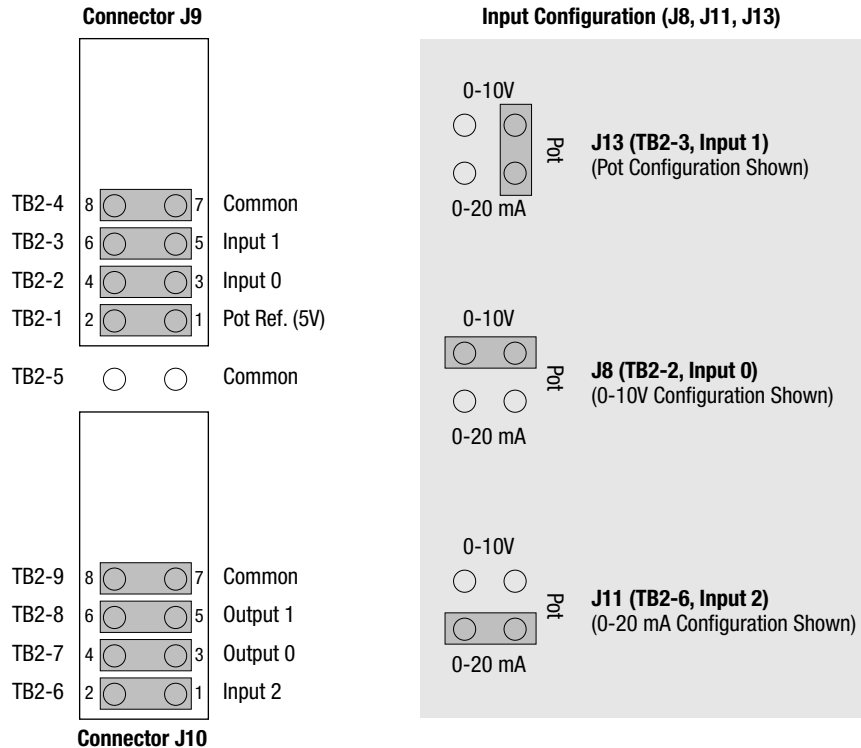

In addition, each input can be configured (see figure above) for 0-10V, 0-20 mA or potentiometer. Placing a jumper across the top of the connector configures that input for 0-10V operation. The bottom provides 0-20 mA and the right-side provides potentiometer operation.

Analog Option Board Installation and Removal

If the drive is not factory configured with Analog Options (LA1, LA2, etc.), the desired option boards can be user installed. Prior to installation, the jumpers at J9 and/or J10 must be removed. If a board is removed at a later time, the jumpers must be reinstalled. Refer to the detailed instructions supplied with the option boards.

Pre-Installation

Motor Cables

A variety of cable types are acceptable for drive installations. For many installations, unshielded cable is adequate, provided it can be separated from sensitive circuits. As an approximate guide, allow a spacing of 0.3 meters (1 foot) for every 10 meters (32.8 feet) of length. In all cases, long parallel runs must be avoided. Do not use cable with an insulation thickness less than or equal to 15 mils (0.4mm/0.015 in.). The cable should be 4-conductor with the ground lead being connected directly to the drive ground terminal (PE) and the motor frame ground terminal.

Shielded Cable

Shielded cable is recommended if sensitive circuits or devices are connected or mounted to the machinery driven by the motor. The shield must be connected to both the drive ground (drive end) and motor frame ground (motor end). The connection must be made at both ends to minimize interference.

If cable trays or large conduits are to be used to distribute the motor leads for multiple drives, shielded cable is recommended to reduce or capture the noise from the motor leads and minimize "cross coupling" of noise between the leads of different drives. The shield should be connected to the ground connections at both the motor and drive end.

Armored cable also provides effective shielding. Ideally it should be grounded only at the drive (PE) and motor frame. Some armored cable has a PVC coating over the armor to prevent incidental contact with grounded structure. If, due to the type of connector, the armor is grounded at the cabinet entrance, shielded cable should be used within the cabinet if power leads will be run close to control signals.

In some hazardous environments it is not permissible to ground both ends of the cable armor because of the possibility of high current circulating at the input frequency if the ground loop is cut by a strong magnetic field. This only applies in the proximity of powerful electrical machines. In such cases, consult factory for specific guidelines.

Conduit

If metal conduit is preferred for cable distribution, the following guidelines must be followed.

- Drives are normally mounted in cabinets and ground connections are made at a common ground point in the cabinet. Normal installation of conduit provides grounded connections to both the motor frame ground (junction box) and drive cabinet ground. These ground connections help minimize interference. This is a noise reduction recommendation only, and does not affect the requirements for safety grounding.
- No more than three sets of motor leads can be routed through a single conduit. This will minimize "cross talk" that could reduce the effectiveness of the noise reduction methods described. If more than three drive/motor connections per conduit are required, shielded cable as previously described must be used. If practical, each conduit should contain only one set of motor leads.



ATTENTION: To avoid a possible shock hazard caused by induced voltages, unused wires in the conduit must be grounded at both ends. For the same reason, if a drive sharing a conduit is being serviced or installed, all drives using this conduit should be disabled. This will eliminate the possible shock hazard from "cross coupled" drive motor leads.

Motor Cables

Motor Lead Lengths

Installations with long cables to the motor may require the addition of output reactors or cable terminators to limit voltage reflections at the motor. Refer to the following tables for the maximum length cable allowed for various installation techniques. For installations that exceed the recommended maximum lengths listed, contact the factory.

MAXIMUM MOTOR CABLE LENGTH RESTRICTIONS IN METERS (FEET) - 380V-480V DRIVES ¹																		
No External Devices							w/1204-TFB2 Term.			w/1204-TFA1 Terminator				Reactor at Drive ²				
Motor							Motor			Motor				Motor				
Drive Frame	Drive kW (HP)	Motor kW (HP)	1600V or 1329R/L (1850V)				A or B			A		B		1329				
			Any Cable	Any Cable	Any Cable	Any Cable ⁶	Cable Type Shld. ³	Unshld.	Any Cable	Cable Type Shld. ³	Unshld.	Cable Type Shld. ³	Unshld.	Any Cable	Any Cable	Any Cable		
A1	0.37 (0.5)	0.37 (0.5)	12.2 (40)	33.5 (110)	91.4 (300)	91.4 (300)	Use 1204-TFA1			30.5 (100)	61.0 (200)	30.5 (100)	61.0 (200)	91.4 (300)	22.9 (75)	182.9 (600)		
			12.2 (40)	33.5 (110)	91.4 (300)	91.4 (300)				30.5 (100)	30.5 (100)	30.5 (100)	30.5 (100)	91.4 (300)	22.9 (75)	182.9 (600)		
	0.37 (0.5)	12.2 (40)	33.5 (110)	91.4 (300)	91.4 (300)	30.5 (100)				61.0 (200)	30.5 (100)	61.0 (200)	91.4 (300)	22.9 (75)	182.9 (600)			
	1.2 (1.5)	1.2 (1.5)	12.2 (40)	33.5 (110)	91.4 (300)	91.4 (300)				30.5 (100)	30.5 (100)	61.0 (200)	61.0 (200)	91.4 (300)	22.9 (75)	182.9 (600)		
	0.75 (1)	12.2 (40)	33.5 (110)	91.4 (300)	91.4 (300)	30.5 (100)				30.5 (100)	61.0 (200)	61.0 (200)	91.4 (300)	22.9 (75)	182.9 (600)			
	0.37 (0.5)	12.2 (40)	33.5 (110)	114.3 (375)	121.9 (400)	30.5 (100)				30.5 (100)	61.0 (200)	61.0 (200)	121.9 (400)	22.9 (75)	182.9 (600)			
	A2	1.5 (2)	1.5 (2)	7.6 (25)	12.2 (40)	91.4 (300)				91.4 (300)	91.4 (300)	91.4 (300)	91.4 (300)	30.5 (100)	30.5 (100)	91.4 (300)	61.0 (200)	91.4 (300)
7.6 (25)				12.2 (40)	114.3 (375)	182.9 (600)	182.9 (600)	182.9 (600)	30.5 (100)	30.5 (100)	91.4 (300)	61.0 (200)	182.9 (600)	22.9 (75)	182.9 (600)			
0.75 (1)		7.6 (25)	12.2 (40)	114.3 (375)	182.9 (600)	182.9 (600)	182.9 (600)	182.9 (600)	30.5 (100)	30.5 (100)	91.4 (300)	61.0 (200)	182.9 (600)	22.9 (75)	182.9 (600)			
0.37 (0.5)		7.6 (25)	12.2 (40)	114.3 (375)	182.9 (600)	182.9 (600)	182.9 (600)	182.9 (600)	30.5 (100)	30.5 (100)	91.4 (300)	61.0 (200)	182.9 (600)	22.9 (75)	182.9 (600)			
2.2 (3)		2.2 (3)	7.6 (25)	12.2 (40)	91.4 (300)	91.4 (300)	182.9 (600)	182.9 (600)	182.9 (600)							22.9 (75)	182.9 (600)	
																7.6 (25)	12.2 (40)	114.3 (375)
A3		3.7 (5)	3.7 (5)	7.6 (25)	12.2 (40)	114.3 (375)	Note For applications/ installations using new motors, no restrictions in lead length due to voltage reflection are necessary. You should observe standard practices for voltage drop, cable capacitance, and other issues.	182.9 (600)	182.9 (600)	182.9 (600)	Use 1204-TFB2						22.9 (75)	182.9 (600)
				2.2 (3)	7.6 (25)	12.2 (40)		114.3 (375)	182.9 (600)	182.9 (600)							182.9 (600)	22.9 (75)
		1.5 (2)	7.6 (25)	12.2 (40)	114.3 (375)	182.9 (600)		182.9 (600)	182.9 (600)	22.9 (75)							182.9 (600)	
		0.75 (1)	7.6 (25)	12.2 (40)	114.3 (375)	182.9 (600)		182.9 (600)	182.9 (600)	22.9 (75)							182.9 (600)	
	0.37 (0.5)	7.6 (25)	12.2 (40)	114.3 (375)	182.9 (600)	182.9 (600)		182.9 (600)	22.9 (75)	182.9 (600)								
A4	5.5-15 (7.5-20)	5.5-15 (7.5-20)	7.6 (25)	12.2 (40)	114.3 (375)	182.9 (600)	182.9 (600)	182.9 (600)							24.4 (80)	182.9 (600)		
B	11-22 (15-30)	11-22 (15-30)	7.6 (25)	12.2 (40)	114.3 (375)	182.9 (600)	182.9 (600)	182.9 (600)							24.4 (80)	182.9 (600)		
C	30-45 (X40-X60)	30-45 (40-60)	7.6 (25)	12.2 (40)	114.3 (375)	182.9 (600)	182.9 (600)	182.9 (600)							76.2 (250)	182.9 (600)		
D	45-112 (60-X150)	45-112 (60-150)	12.2 (40)	30.5 (100)	114.3 (375)	182.9 (600)	182.9 (600)	182.9 (600)							61.0 (200)	91.4 (300)		
E	112-187 (150-250)	112-224 (150-300)	12.2 (40)	53.3 (175)	114.3 (375)	182.9 (600)	182.9 (600)	182.9 (600)							182.9 (600)	182.9 (600)		
F	187-336 (250-450)	187-336 (250-450)	18.3 (60)	53.3 (175)	114.3 (375)	182.9 (600)	182.9 (600)	182.9 (600)							182.9 (600)	182.9 (600)		
G	187-448 (X250-600)	187-448 (250-600)	18.3 (60)	53.3 (175)	114.3 (375)	182.9 (600)	182.9 (600)	182.9 (600)							182.9 (600)	182.9 (600)		

Type A Motor Characteristics: No phase paper or misplaced phase paper, lower quality insulation systems, corona inception voltages between 850 and 1000 volts.

Type B Motor Characteristics: Properly placed phase paper, medium quality insulation systems, corona inception voltages between 1000 and 1200 volts.

1329R/L Motors: These AC Variable Speed motors are "Control-Matched" for use with Allen-Bradley Drives. Each motor is designed to meet or exceed the requirements of the Federal Energy Act of 1992. All 1329R/L motors are optimized for variable speed operation and include premium inverter grade insulation systems which meet or exceed NEMA MG1, Part 31.40.4.2.

Pre-Installation

Motor Cables

MAXIMUM MOTOR CABLE LENGTH RESTRICTIONS IN METERS (FEET) - 500V-600V DRIVES ⁴																		
			No External Devices			w/1204-TFB2 Terminator			w/1204-TFA1 Terminator			Reactor at Drive ²						
			Motor			Motor			Motor			Motor						
			A	B	1329R/L ⁵	A	B	1600V or 1329R/L ⁵ (1850V)	A	B	1600V or 1329R/L ⁵ (1850V)	A	B	1600V or 1329R/L ⁵ (1850V)				
Drive Frame (HP)	Drive kW (HP)	Motor kW (HP)	Any Cable	Any Cable	Any Cable	Any Cable	Any Cable	Any Cable	Any Cable	Any Cable	Any Cable	Any Cable	Any Cable	Any Cable				
A4	0.75 (1)	0.75 (1)	NR	NR	NA	NR	182.9 (600)	335.3 (1100)	NR	61.0 (200)	NA	Not Recommended						
		0.37 (0.5)	NR	NR	NA	NR	182.9 (600)	335.3 (1100)	NR	61.0 (200)	182.9 (600)							
	1.5 (2)	1.5 (2)	NR	NR	NA	NR	NA	335.3 (1100)	NR	61.0 (200)	NA							
		1.2 (1.5)	NR	NR	NA	NR	182.9 (600)	335.3 (1100)	NR	61.0 (200)	182.9 (600)							
	2.2 (3)	0.75 (1)	NR	NR	182.9 (600)	NR	182.9 (600)	335.3 (1100)	NR	61.0 (200)	182.9 (600)							
		0.37 (0.5)	NR	NR	182.9 (600)	NR	182.9 (600)	335.3 (1100)	NR	61.0 (200)	182.9 (600)							
		2.2 (3)	NR	NR	NA	NR	182.9 (600)	335.3 (1100)	NR	61.0 (200)	NA							
		1.5 (2)	NR	NR	NA	NR	182.9 (600)	335.3 (1100)	NR	61.0 (200)	NA							
	3.7 (5)	0.75 (1)	NR	NR	182.9 (600)	NR	182.9 (600)	335.3 (1100)	NR	61.0 (200)	182.9 (600)							
		0.37 (0.5)	NR	NR	182.9 (600)	NR	182.9 (600)	335.3 (1100)	NR	61.0 (200)	182.9 (600)							
		3.7 (5)	NR	NR	NA	NR	182.9 (600)	NA	NR	61.0 (200)	NA							
		2.2 (3)	NR	NR	NA	NR	182.9 (600)	NA	NR	61.0 (200)	NA							
		1.5 (2)	NR	NR	182.9 (600)	NR	182.9 (600)	NA	NR	61.0 (200)	NA							
		0.75 (1)	NR	NR	182.9 (600)	NR	182.9 (600)	335.3 (1100)	NR	61.0 (200)	182.9 (600)							
	5.5-15 (7.5-20)	5.5-15 (7.5-20)	NR	9.1 (30)	182.9 (600)	91.4 (300)	182.9 (600)	182.9 (600)	NR	61.0 (200)	182.9 (600)				30.5 (100)	91.4 (300)	182.9 (600)	
		18.5-45 (25-60)	NR	9.1 (30)	182.9 (600)	91.4 (300)	182.9 (600)	182.9 (600)	NR	61.0 (200)	182.9 (600)				30.5 (100)	91.4 (300)	182.9 (600)	
	D	56-93 (75-125)	56-93 (75-125)	NR	9.1 (30)	182.9 (600)	91.4 (300)	182.9 (600)	182.9 (600)	NR	61.0 (200)				182.9 (600)	61.0 (200)	91.4 (300)	182.9 (600)
				NR	9.1 (30)	182.9 (600)	91.4 (300)	182.9 (600)	182.9 (600)	NR	61.0 (200)				182.9 (600)	182.9 (600)	182.9 (600)	182.9 (600)
E	112-224 (150-X300)	112-224 (150-X300)	NR	9.1 (30)	182.9 (600)	91.4 (300)	182.9 (600)	182.9 (600)	NR	61.0 (200)	182.9 (600)	182.9 (600)	182.9 (600)	182.9 (600)				
			NR	9.1 (30)	182.9 (600)	91.4 (300)	182.9 (600)	182.9 (600)	NR	61.0 (200)	182.9 (600)	182.9 (600)	182.9 (600)	182.9 (600)				
F	261-298 (350-400)	261-298 (350-400)	NR	9.1 (30)	182.9 (600)	91.4 (300)	182.9 (600)	182.9 (600)	NR	61.0 (200)	182.9 (600)	182.9 (600)	182.9 (600)	182.9 (600)				
			NR	9.1 (30)	182.9 (600)	91.4 (300)	182.9 (600)	182.9 (600)	NR	61.0 (200)	182.9 (600)	182.9 (600)	182.9 (600)	182.9 (600)				
G	224-448 (300-600)	224-448 (300-600)	NR	9.1 (30)	182.9 (600)	91.4 (300)	182.9 (600)	182.9 (600)	NR	61.0 (200)	182.9 (600)	182.9 (600)	182.9 (600)	182.9 (600)				
			NR	9.1 (30)	182.9 (600)	91.4 (300)	182.9 (600)	182.9 (600)	NR	61.0 (200)	182.9 (600)	182.9 (600)	182.9 (600)	182.9 (600)				

NR = Not Recommended

NA = Not Available at time of printing

¹ Values shown are for 480V nominal input voltage, drive carrier frequency of 2 kHz and ambient temperature at the motor of 40°C. Consult factory regarding operation at carrier frequencies above 2 kHz. Multiply values by 0.85 for high line conditions. For input voltages of 380, 400 or 415V AC, multiply the table values by 1.25, 1.20 or 1.15, respectively.

² A 3% reactor reduces motor and cable stress but may cause a degradation of motor waveform quality. Reactors must have a turn-turn insulation rating of 2100 volts or higher.

³ Includes wire in conduit.

⁴ Values shown are for nominal input voltage and drive carrier frequency of 2 kHz. Consult factory regarding operation at carrier frequencies above 2 kHz. Multiply values by 0.85 for high line conditions.

⁵ When used on 600V systems, 1329R or 1329L motors have a corona inception voltage rating of approximately 1850V.

⁶ These distance restrictions are due to charging of cable capacitance and may vary from application to application.

Output Devices

Drive Output Disconnection



ATTENTION: The hazard for injury or death from electric shock may exist if a disconnecting means is wired to drive output terminals and is opened during drive operation. Any disconnecting means wired to drive output terminals U, V, and W must be capable of disabling the drive if opened during drive operation. An auxiliary contact must be used to simultaneously disable the drive.

Common Mode Cores

Common Mode Cores will help reduce the common mode noise at the drive output and guard against interference with other electrical equipment (programmable controllers, sensors, analog circuits, etc.). In addition, reducing the PWM carrier frequency will reduce the effects and lower the risk of common mode noise interference. Refer to the table below.

1336 PLUS Common Mode Chokes

Catalog Number	Used with . . .	Description
1321-M001	Communications Cables, Analog Signal Cables, etc.	Open Style - Signal Level
1321-M009	All 1336 PLUS Drives Rated: 480V, 0.37-3.7 kW (0.5-5 HP)	Open Style with Terminal Block, 9A
1321-M048	All 1336 PLUS Drives Rated: 480V, 5.5-22 kW (7.5-30 HP) 600V, 5.5-30 kW (7.5-40 HP)	Open Style, 48A
1321-M180	All 1336 PLUS Drives Rated: 480V, 30-112 kW (40-X150 HP) 600V, 37-93 kW (50-125 HP)	Open Style, 180A
1321-M670	All 1336 PLUS Drives Rated: 480V, 112-448 kW (150-600 HP) 600V, 149-448 kW (200-600 HP)	Open Style, 670A

Pre-Installation

Cable Termination

Optional Cable Terminator

Voltage doubling at motor terminals, known as reflected wave phenomenon, standing wave or transmission line effect, can occur when using drives with long motor cables.

Inverter duty motors with phase-to-phase insulation ratings of 1200 volts or higher should be used to minimize effects of reflected wave on motor insulation life.

Applications with non-inverter duty motors or any motor with exceptionally long leads may require an output filter or cable terminator. A filter or terminator will help limit reflection to the motor, to levels which are less than the motor insulation rating.

The tables on pages **52** and **53** list the maximum recommended cable length for unterminated cables, since the voltage doubling phenomenon occurs at different lengths for different drive ratings. If your installation requires longer motor cable lengths, a reactor or cable terminator is recommended. Also, refer to these tables for frequency, cable length and voltage restrictions of 1204-TFA1 or 1204-TFB2 terminators.

Optional Output Reactor

Bulletin 1321 Reactors listed in the 1336 PLUS-3.0 Price Sheet can be used for drive input and output. These reactors are specifically constructed to accommodate IGBT inverter applications with switching frequencies up to 20 kHz. They have a UL approved dielectric strength of 4000 volts, opposed to a normal rating of 2500 volts. The first two and last two turns of each coil are triple insulated to guard against insulation breakdown resulting from high dv/dt. When using motor line reactors, it is recommended that the drive PWM frequency be set to its lowest value to minimize losses in the reactors.

Important: By using an output reactor the effective motor voltage will be lower because of the voltage drop across the reactor - this may also mean a reduction of motor torque.

User Supplied Enclosures

1336 PLUS II drives installed in user supplied enclosures may be mounted within an enclosure or may be mounted to allow the heatsink to extend outside the enclosure. Use the following information in combination with the enclosure manufacturer's guidelines for sizing.

User Supplied Enclosures

Cat No.	Base Derate Amps ¹	Derate Curve ^{2, 3}	Heat Dissipation Drive Watts ^{2, 3, 4}	Heatsink Watts ²	Total Watts ²
200-240V DRIVES					
AQF05	2.3	Figure A	13 (9)	15 (11)	28 (20)
AQF07	3.0	Figure A	15 (11)	21 (15)	36 (26)
AQF10	4.5	Figure A	17 (12)	32 (23)	49 (35)
AQF15	6.0	Figure A	21 (15)	42 (30)	63 (46)
AQF20	8.0	Figure A	25 (18)	56 (40)	81 (59)
AQF30	12	Figure A	33 (24)	72 (52)	105 (76)
AQF50	18	Figure A	42 (30)	116 (84)	158 (114)
AQF75	22	Figure A	58	186	244
A007	27	No Derate	156	486	642
A010	34	Figure B	200	721	921
A015	48	Figure D	205	819	1024
A020	65	No Derate	210	933	1143
A025	77	No Derate	215	1110	1325
A030	80	No Derate	220	1110	1330
A040	120	Figure G	361	1708	2069
A050	150	Figure H	426	1944	2370
A060	180	Figure J	522	2664	3186
A075	240	Figure L	606	2769	3375
A100	291	Figure M	755	3700	4455
A125	325	Figure N	902	4100	5002
380-480V DRIVES					
BRF05	1.2	Figure A	12	9	21
BRF07	1.7	Figure A	13	15	28
BRF10	2.3	Figure A	15	20	35
BRF15	3.0	Figure A	16 (12)	27 (21)	43 (33)
BRF20	4.0	Figure A	19 (15)	36 (28)	55 (43)
BRF30	6.0	Figure A	23 (18)	54 (42)	77 (60)
BRF50	9.0	Figure A	29 (23)	84 (65)	113 (88)
BRF75	15.4	Figure A	58	186	244
BRF100	22.0	Figure A	68	232	300
BRF150	24.0	Figure A	88	332	420
BRF200	27.0	Figure A	96	356	452
B015	27	No Derate	117	486	603
B020	34	Figure B	140	628	768
B025	42	Figure C	141	720	861
B030	48	Figure D	141	820	961
BX040	59	Figure E	175	933	1108
B040	65	Figure E	175	933	1108
B050	77	Figure F	193	1110	1303
BX060	77	Figure F	193	1110	1303
B060	96	No Derate	361	1708	2069
B075	120	Figure G	361	1708	2069
B100	150	Figure H	426	1944	2370
B125	180	Figure J	522	2664	3186
BX150	180	Figure J	606	2769	3375
B150	240	Figure L	606	2769	3375
B200	292	Figure M	755	3700	4455
B250	325	Figure N	902	4100	5002
BP/BPR250 ⁶	322	Figure O	491	4658	5149
BX250	360	No Derate	902	4100	5002
B300 ⁵	425	No Derate	1005	4805	5810
BP/BPR300 ⁶	357	Figure P	619	5342	5961
B350 ⁵	475	No Derate	1055	5455	6510
BP/BPR350 ⁶	421	Figure Q	733	6039	6772
B400 ⁵	525	No Derate	1295	6175	7470
BP/BPR400 ⁶	471	Figure R	793	6329	7122
B450 ⁵	590	No Derate	1335	6875	8210
BPBPR450 ⁶	527	Figure S	931	7000	7931
B500 ⁵	670	Figure T	1395	7525	8920
B600 ⁵	670	Figure T	1485	8767	10252
500-600V DRIVES					
CWF10	2.4	Figure U	25	29	54
CWF20	4.8	Figure U	29	57	86
CWF30	7.2	Figure U	32	87	119
CWF50	9.6	Figure U	35	117	152
CWF75	10	Figure U	38	148	186
CWF100	12	Figure U	41	177	218
CWF150	19	Figure U	52	286	338
CWF200	24	Figure U	60	358	418
C025	30	No Derate	141	492	633
C030	35	No Derate	141	526	667
C040	45	No Derate	175	678	853
C050	57	No Derate	193	899	1092
C060	62	No Derate	193	981	1174
C075	85	Figure G	361	1533	1894
C100	109	Figure I	426	1978	2404
C125	138	Figure K	522	2162	2683
C150	168	Figure V	606	2315	2921
C200	252	Figure W	755	3065	3820
C250	284	Figure X	890	3625	4515
CX300	300	Figure Y	940	3990	4930
C300 ⁵	300	Figure AB & AC	926	5015	5941
C350 ⁵	350	Figure AB & AC	1000	5935	6935
CP/CPR350	350	Figure Z	580	6125	6705
C400 ⁵	400	Figure AB & AC	1430	7120	8550
CP/CPR400	400	Figure AA	711	7000	7711
C450 ⁵	450	Figure AB & AC	1465	8020	9485
C500 ⁵	500	Figure AB & AC	1500	8925	10425
C600 ⁵	600	Figure AB & AC	1610	10767	12377

(parenthesis) in table indicates Series C drive ratings.

- Base Derate Amps are based on nominal voltage (240, 480 or 600V). If input voltage exceeds Drive Rating, Drive Output must be derated. **Refer to Figure AE.**
- Rating is at 4 kHz (2 kHz for 224-448 kW/300-600 HP, 500-600V). If Carrier frequencies above 4 kHz are selected, drive rating must be derated. **Refer to Figure A-AC.**
- Drive Ambient Temperature Rating is 40° C. If ambient exceeds 40° C, the drive must be derated. **Refer to Figure A-AC.**
- Drive Rating is based on altitudes of 1,000 m (3,000 ft) or less. If installed at higher altitude, drive must be derated. **Refer to Figure AD.**
- Important:** Two (2) 725 CFM fans are required if an open type drive is mounted in a user supplied enclosure.
- Important:** 1336F-BPRxxx drives require two (2) fans capable of producing greater than 450 CFM, if an open type drive is mounted in a user supplied enclosure.

Pre-Installation

Derating Guidelines

Drive ratings can be affected by a number of factors. If more than one factor exists, derating percentages must be multiplied. For example, if a 14 Amp drive (B007) is installed at a 2,000 m (6,600 ft.) altitude **and** has a 2% high input line voltage, the actual amp rating will be:

$$14 \times 94\% \text{ Altitude Derate} \times 96\% \text{ High Line Derate} = 12.6 \text{ Amps.}$$

Ambient Temperature/Carrier Frequency

Standard Rating for Enclosed Drive in 40° C Ambient & Open Drive in 50° C Ambient.
 Derating Factor for Enclosed Drive in Ambient between 41° C & 50° C.

Figure A
1336F-AQF05-AQF75 and BRF05-BRF200

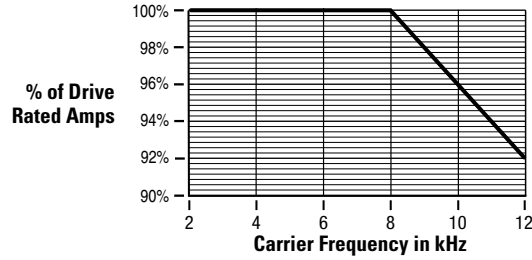

Figure B
1336F-A010 and B020

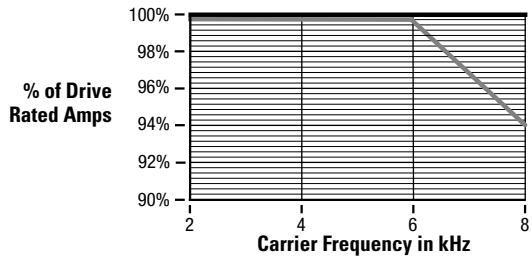

Figure C
1336F-B025

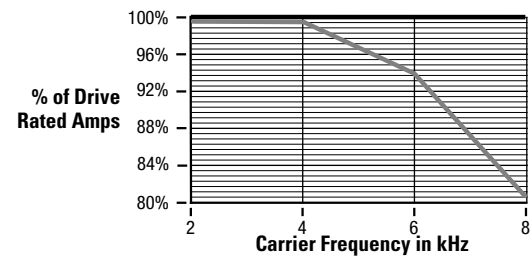

Figure D
1336F-A015 and B030

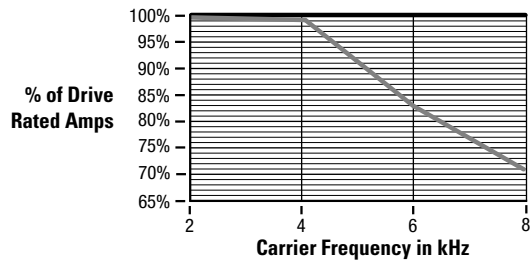
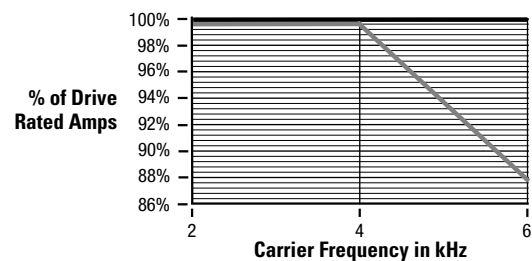

Figure E
1336F-B040 and BX040



Derating Guidelines

█ Standard Rating for Enclosed Drive in 40°C Ambient & Open Drive in 50°C Ambient.
█ Derating Factor for Enclosed Drive in Ambient between 41°C & 50°C.

Figure F
1336F-B050 and BX060

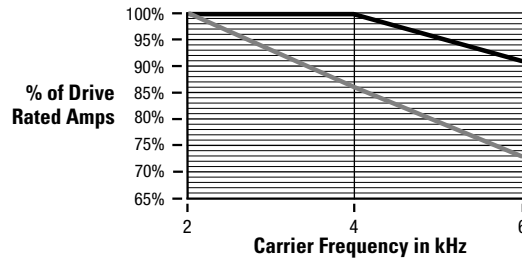

Figure G
1336F-A040, B075, C075

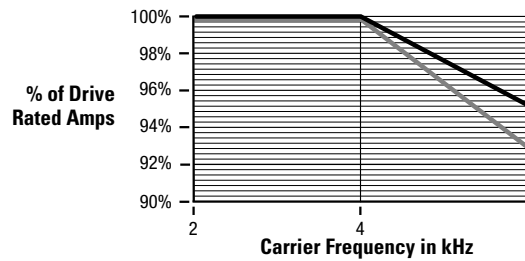

Figure H
1336F-A050, B100

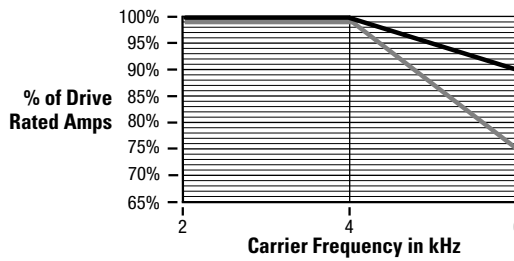

Figure I
1336F-C100

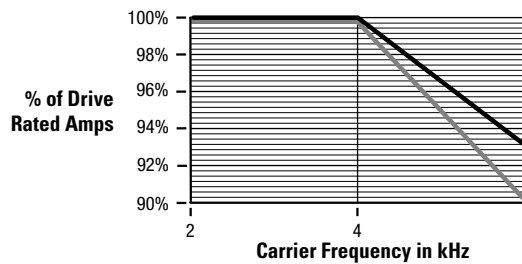

Figure J
1336F-A060, B125, BX150

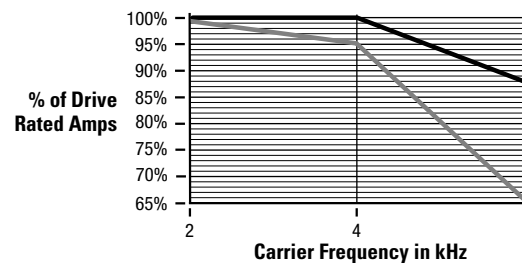
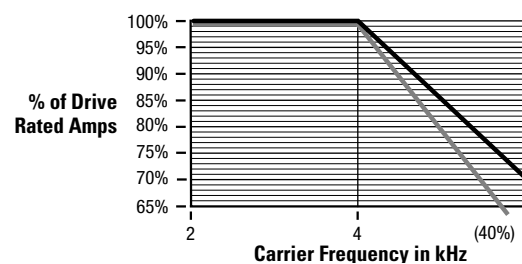

Figure K
1336F-C125



Pre-Installation

Derating Guidelines

Standard Rating for Enclosed Drive in 40°C Ambient & Open Drive in 50°C Ambient.
 Derating Factor for Enclosed Drive in Ambient between 41°C & 50°C.

Figure L
1336F-A075, B150

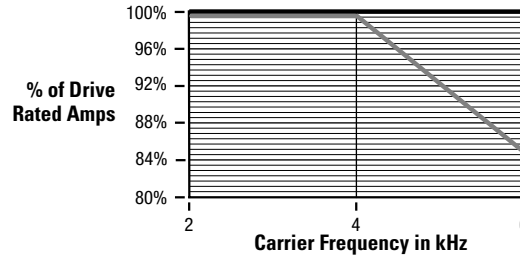

Figure M
1336F-A100, B200

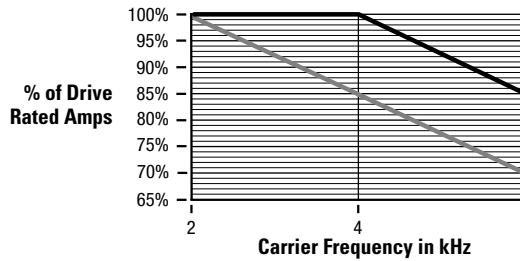

Figure N
1336F-A125, B250

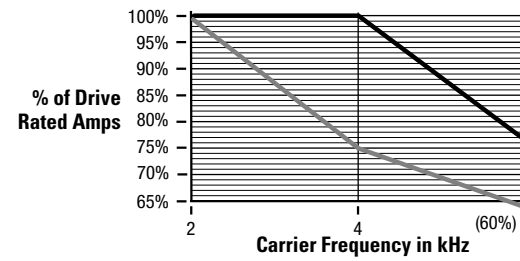

Figure O
1336F-BP250, BPR250

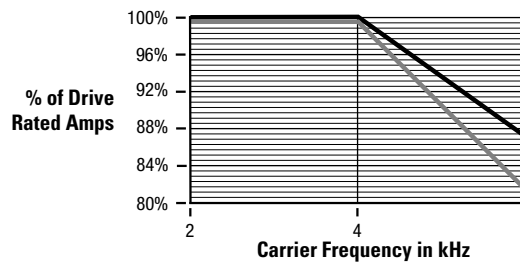

Figure P
1336F-BP300, BPR300

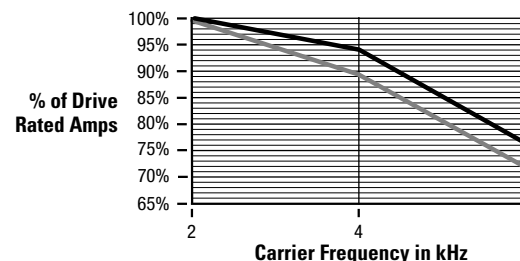
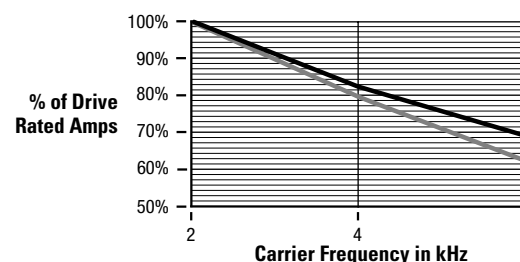

Figure Q
1336F-BP350, BPR350



Derating Guidelines

█ Standard Rating for Enclosed Drive in 40°C Ambient & Open Drive in 50°C Ambient.
█ Derating Factor for Enclosed Drive in Ambient between 41°C & 50°C.

Figure R
1336F-BP400, BPR400

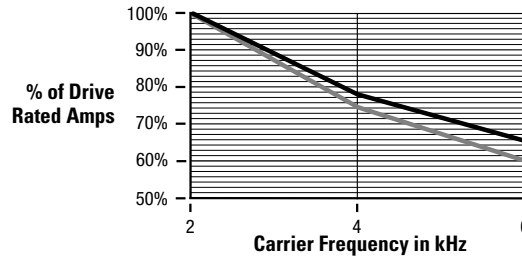

Figure S
1336F-BP450, BP450

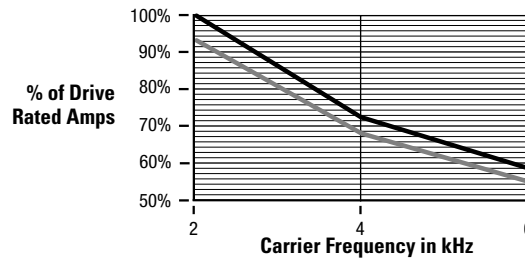

Figure T
1336F-B500 and B600

Assumes two (2) 725 CFM cooling fans for IP 20 (NEMA Type 1) enclosure

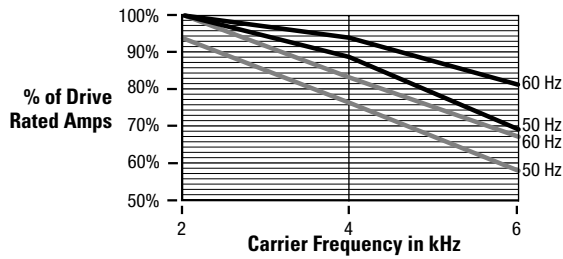

Figure U
1336F-CWF10 through CWF200

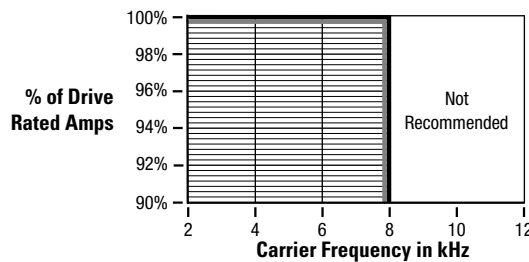

Figure V
1336F-C150

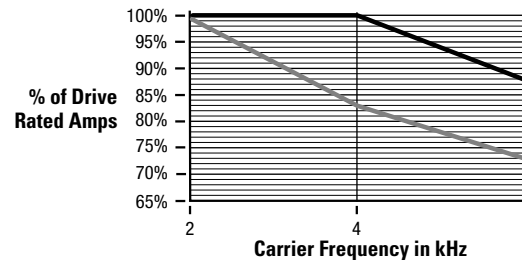
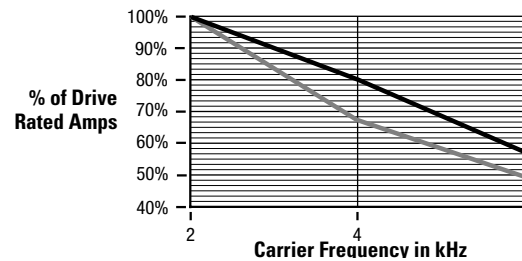

Figure W
1336F-C200



Pre-Installation

Derating Guidelines

— Standard Rating for Enclosed Drive in 40° C Ambient & Open Drive in 50° C Ambient.
— Derating Factor for Enclosed Drive in Ambient between 41° C & 50° C.

Figure X
1336F-C250

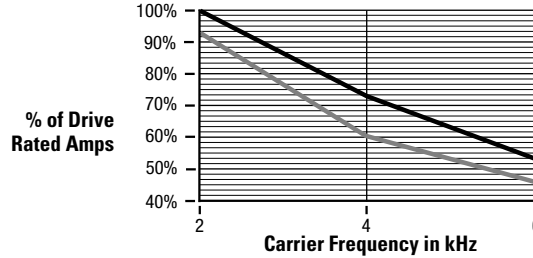

Figure Y
1336F-CX300

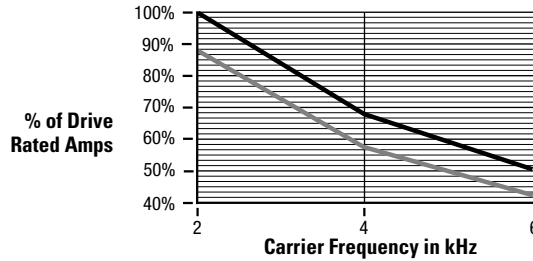

Figure Z
1336F-CP350, CPR350

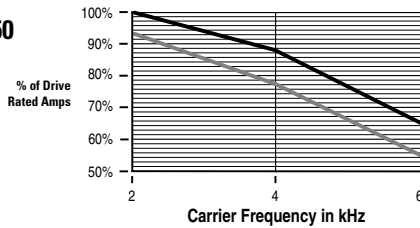

Figure AA
1336F-CP400, CPR450

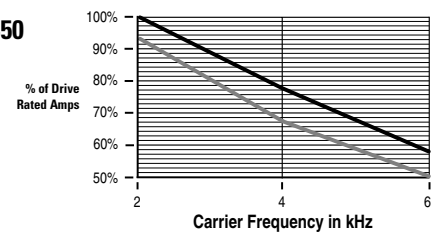

Figure AB
1336F-C300 through C600
Enclosed Drive
in 40° C Ambient
Assumes two (2)
725 CFM cooling fans for
IP 20 (NEMA Type 1) enclosure

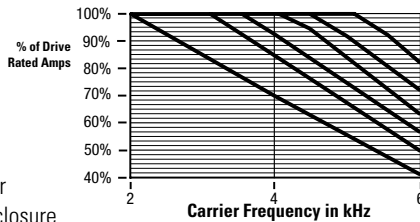
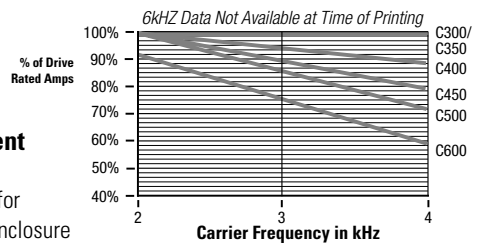

Figure AC
1336F-C300 through C600
Enclosed Drive
in 41° - 50° C Ambient
Assumes two (2)
725 CFM cooling fans for
IP 20 (NEMA Type 1) enclosure



Altitude/High Input Voltage

Figure AD
Altitude – All Drive Ratings

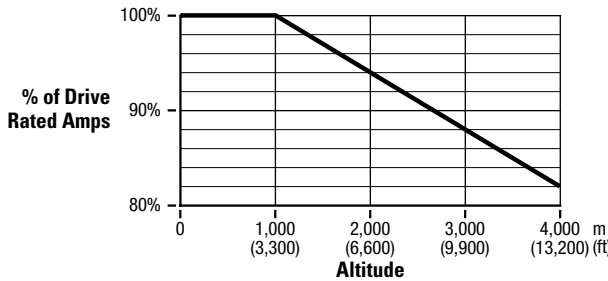
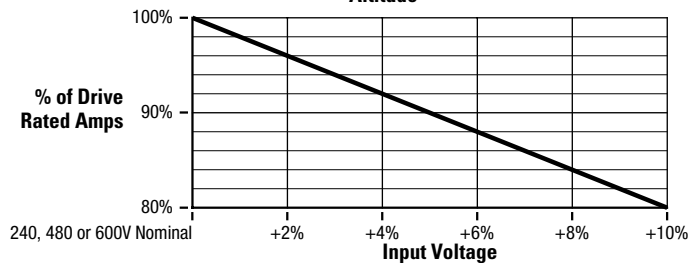
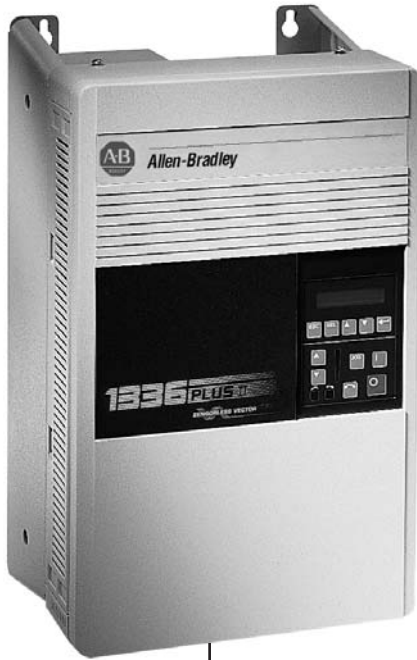

Figure AE
High Input Voltage
Required Only
for the following drives:
1336F-x025 – 18.5 kW (25 HP) at 8 kHz
1336F-x030 – 22 kW (30 HP) at 6 or 8 kHz
1336F-x060 – 45 kW (60 HP) at 6 kHz



1336 PLUS II Remote Device Distances

Total cable length between each device and the drive must be 10 meters (33 feet) or less.



Total cable distance between each device & drive must be 10 meters (33 feet) or less.

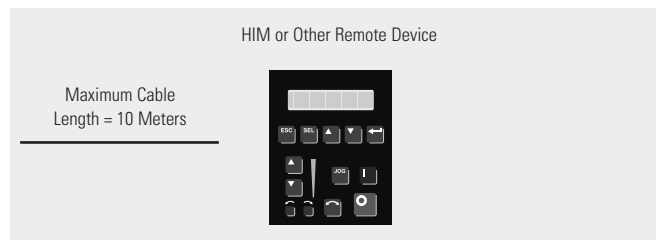
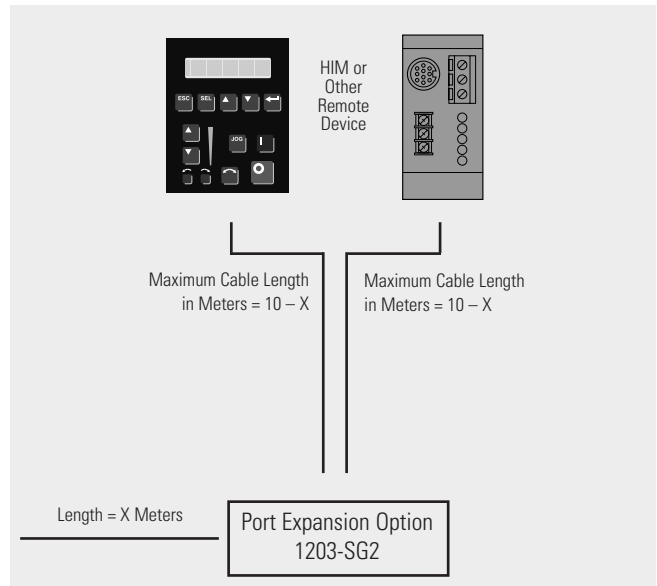

Pre-Installation

Notes

1336 PLUS II Selection Guide



Catalog Number Explanation

1336F	A007	AA	EN	LA6	HAS1	GM1
BULLETIN NO.	VOLTAGE/RATING	ENCLOSURE (MUST BE SPECIFIED)	LANGUAGE (MUST BE SPECIFIED) ¹	CONTROL INTERFACE (OPTIONAL) ²	HUMAN INTERFACE (OPTIONAL) ²	COMMUNICATION CARD (OPTIONAL) ²

¹ A Language Module must be specified with each drive.

² At least one of either a Control Interface, Human Interface or Communication Card Option will be required to make the drive functional. The chosen option(s) may be ordered factory installed or as add-on kits.

1336 PLUS II Selection Guide

Constant/Variable Torque Drives and Enclosures

200-240V

Drive Rating ¹ Constant Torque				Open IP00	NEMA Type 1 IP20	NEMA Type 4 IP65	NEMA Type 12 IP54
Amps	kW	CT HP	VT HP ²	No Enclosure	General Purpose	Resist Water, Dust	Industrial Use
2.3	0.37	0.5	0.5	AQF05 – AN	AQF05 – AA	AQF05 – AF	AQF05 – AJ
3.0	0.56	0.75	0.75	AQF07 – AN	AQF07 – AA	AQF07 – AF	AQF07 – AJ
4.5	0.75	1	1	AQF10 – AN	AQF10 – AA	AQF10 – AF	AQF10 – AJ
6.0	1.2	1.5	1.5	AQF15 – AN	AQF15 – AA	AQF15 – AF	AQF15 – AJ
8.0	1.5	2	2	AQF20 – AN	AQF20 – AA	AQF20 – AF	AQF20 – AJ
12	2.2	3	3	AQF30 – AN	AQF30 – AA	AQF30 – AF	AQF30 – AJ
18	4.0	5	5	AQF50 – AN	AQF50 – AA	AQF50 – AF	AQF50 – AJ
22	5.5	7.5	7.5	AQF75 – AN	AQF75 – AA	AQF75 – AF	AQF75 – AJ
22	5.5	7.5	7.5	A007 – AN	A007 – AA	A007 – AF	A007 – AJ
34	7.5	10	10	A010 – AN	A010 – AA	A010 – AF	A010 – AJ
48	11	15	15	A015 – AN	A015 – AA	A015 – AF	A015 – AJ
65	15	20	20	A020 – AN	A020 – AA	A020 – AF	A020 – AJ
77	18.5	25	25	A025 – AN	A025 – AA	A025 – AF	A025 – AJ
80	22	30	30	A030 – AN	A030 – AA	A030 – AF	A030 – AJ
120	30	40	40	A040 – AN	A040 – AA	3	3
150	37	50	50	A050 – AN	A050 – AA	3	3
180	45	60	60	A060 – AN	A060 – AA	3	3
240	56	75	75	A075 – AN	A075 – AA ⁹	3	3
291	75	100	100	A100 – AN	A100 – AA ⁹	3	3
325	93	125	125	A125 – AN	A125 – AA ⁹	3	3

380-480V

Drive Rating ¹ Constant Torque				Drive Rating ¹ Variable Torque				Open IP00	NEMA Type 1 IP20	NEMA Type 1 IP20	NEMA Type 4 IP65	NEMA Type 12 IP54
Amps	HP	Amps	HP ²	Amps	kW	Amps	kW	No Enclosure	General Purpose	CE/C-tick Conformance	Resist Water, Dust	Industrial Use
1.1	0.5	1.2	0.5	1.1	0.37	1.2	0.37	BRF05 – AN	BRF05 – AA	BRF05 – AE	BRF05 – AF	BRF05 – AJ
1.6	0.75	1.7	0.75	1.6	0.56	1.7	0.56	BRF07 – AN	BRF07 – AA	BRF07 – AE	BRF07 – AF	BRF07 – AJ
2.1	1	2.3	1	2.1	0.75	2.3	0.75	BRF10 – AN	BRF10 – AA	BRF10 – AE	BRF10 – AF	BRF10 – AJ
2.8	1.5	3.0	1.5	2.8	1.2	3.0	1.2	BRF15 – AN	BRF15 – AA	BRF15 – AE	BRF15 – AF	BRF15 – AJ
3.8	2	4.0	2	3.8	1.5	4.0	1.5	BRF20 – AN	BRF20 – AA	BRF20 – AE	BRF20 – AF	BRF20 – AJ
5.3	3	6.0	3	5.3	2.2	6.0	2.2	BRF30 – AN	BRF30 – AA	BRF30 – AE	BRF30 – AF	BRF30 – AJ
8.4	5	9.0	5	8.4	3.7	9.0	3.7	BRF50 – AN	BRF50 – AA	BRF50 – AE	BRF50 – AF	BRF50 – AJ
13.3	7.5	15.4	10	13.3	5.5	15.4	5.5	BRF75 – AN	BRF75 – AA	BRF75 – AE	BRF75 – AF	BRF75 – AJ
16.1	10	22.0	15	16.1	7.5	22.0	11	BRF100 – AN	BRF100 – AA	BRF100 – AE	BRF100 – AF	BRF100 – AJ
24.0	15	24.0	15	24.0	11	24.0	11	BRF150 – AN	BRF150 – AA	BRF150 – AE	BRF150 – AF	BRF150 – AJ
27.0	20	27.0	20	27.0	15	27.0	15	BRF200 – AN	BRF200 – AA	BRF200 – AE	BRF200 – AF	BRF200 – AJ
24.2	15	27	20	24.2	11	27	15	B015 – AN	B015 – AA	B015 – AE	B015 – AF	B015 – AJ
31	20	34	25	31	15	34	18.5	B020 – AN	B020 – AA	B020 – AE	B020 – AF	B020 – AJ
39	25	42	30	39	18.5	42	22	B025 – AN	B025 – AA	B025 – AE	B025 – AF	B025 – AJ
45	30	48	30	45	22	48	22	B030 – AN	B030 – AA	B030 – AE	B030 – AF	B030 – AJ
59	40	59	40	59	30	59	30	BX040 – AN	BX040 – AA	BX040 – AE	BX040 – AF	BX040 – AJ
60	40	65	50	60	30	65	37	B040 – AN	B040 – AA	B040 – AE	B040 – AF	B040 – AJ
75	50	75	60	75	37	75	45	B050 – AN	B050 – AA	B050 – AE	B050 – AF	B050 – AJ
77	60	77	60	77	45	77	45	BX060 – AN ⁴	BX060 – AA ⁴	BX060 – AE ⁴	BX060 – AF ⁴	BX060 – AJ ⁴
85	60	96	75	85	45	96	56	B060 – AN	B060 – AA	B060 – AE	3	3
106	75	120	100	106	56	120	75	B075 – AN	B075 – AA	B075 – AE	3	3
138	100	150	125	138	75	150	93	B100 – AN	B100 – AA	B100 – AE	3	3
173	125	180	150	173	93	180	112	B125 – AN	B125 – AA	B125 – AE	3	3
180	150	180	150	180	112	180	112	BX150 – AN	BX150 – AA	BX150 – AE	3	3
199	150	240	200	199	112	240	149	B150 – AN	B150 – AA ⁹	B150 – AE ⁹	3	3
263	200	292	250	263	149	292	187	B200 – AN	B200 – AA ⁹	B200 – AE ⁹	3	3
325	250	325	250	325	187	325	187	B250 – AN	B250 – AA ⁹	B250 – AE ⁹	3	3
325	250	360	300	325	187	360	224	BP250 – AN ⁷	BP250 – AA ^{7,9}	–	3	3
								BPR250 – AN ⁷	–	BPR250A – AE ^{7,8,9}		
325	250	360	300	325	187	360	224	BX250 – AN	BX250A – AA ⁹	BX250A – AE ^{8,9}	3	3
360	300	425	350	360	224	425	261	B300 – AN	B300A – AA ⁹	B300A – AE ^{8,9}	3	3
360	300	425	350	360	224	425	261	BP300 – AN ⁷	BP300 – AA ^{7,9}	–	3	3
								BPR300 – AN ⁷	–	BPR300A – AE ^{7,8,9}		
425	350	475	400	425	261	475	298	B350 – AN	B350A – AA ⁹	B350A – AE ^{8,9}	3	3
425	350	475	400	425	261	475	298	BP350 – AN ⁷	BP350 – AA ^{7,9}	–	3	3
								BPR350 – AN ⁷	–	BPR350A – AE ^{7,8,9}		
475	400	525	450	475	298	525	336	B400 – AN	B400A – AA ⁹	B400A – AE ^{8,9}	3	3
475	400	532	450	475	298	532	336	BP400 – AN ⁷	BP400 – AA ^{7,9}	–	3	3
								BPR400 – AN ⁷	–	BPR400A – AE ^{7,8,9}		
525	450	590	500	525	336	590	373	B450 – AN	B450A – AA ⁹	B450A – AE ^{8,9}	3	3
532	450	532	450	532	336	532	336	BP450 – AN ⁷	BP450 – AA ^{7,9}	–	3	3
								BPR450 – AN ⁷	–	BPR450A – AE ^{7,8,9}		
590	500	670	600	590	373	670	448	B500 – AN	B500A – AA ⁹	B500A – AE ^{8,9}	3	3
670	600	670	600	670	448	670	448	B600 – AN	B600A – AA ⁹	B600A – AE ^{8,9}	3	3

Constant/Variable Torque Drives and Enclosures

500-600V

Drive Rating ¹				Open IP00	NEMA Type 1 IP20	NEMA Type 4 IP65	NEMA Type 12 IP54
Amps	kW	CT HP	VT HP	No Enclosure	General Purpose	Resist Water, Dust	Industrial Use
2.0	0.75	1	1	CWF10 – AN	CWF10 – AA	CWF10 – AF	CWF10 – AJ
4.0	1.5	2	2	CWF20 – AN	CWF20 – AA	CWF20 – AF	CWF20 – AJ
6.0	2.2	3	3	CWF30 – AN	CWF30 – AA	CWF30 – AF	CWF30 – AJ
8.0	3.7	5	5	CWF50 – AN	CWF50 – AA	CWF50 – AF	CWF50 – AJ
10	5.5	7.5	7.5	CWF75 – AN	CWF75 – AA	CWF75 – AF	CWF75 – AJ
12	7.5	10	10	CWF100 – AN	CWF100 – AA	CWF100 – AF	CWF100 – AJ
19	11	15	15	CWF150 – AN	CWF150 – AA	CWF150 – AF	CWF150 – AJ
24	15	20	20	CWF200 – AN	CWF200 – AA	CWF200 – AF	CWF200 – AJ
30	18.5	25	25	C025 – AN	C025 – AA	C025 – AF	C025 – AJ
35	22	30	30	C030 – AN	C030 – AA	C030 – AF	C030 – AJ
45	30	40	40	C040 – AN	C040 – AA	C040 – AF	C040 – AJ
57	37	50	50	C050 – AN	C050 – AA	C050 – AF	C050 – AJ
62	45	60	60	C060 – AN	C060 – AA	C060 – AF	C060 – AJ
85	56	75	75	C075 – AN	C075 – AA	3	3
109	75	100	100	C100 – AN	C100 – AA	3	3
138	93	125	125	C125 – AN	C125 – AA	3	3
158	112	150	150	C150 – AN	C150 – AA ⁹	3	3
252	149	200	200	C200 – AN	C200 – AA ⁹	3	3
284	187	250	250	C250 – AN	C250 – AA ⁹	3	3
300	224	300	300	CX300 – AN	CX300 – AA ⁹	3	3
350	261	350	350	CP350 – AN ⁷	CP350 – AA ^{7, 9}	3	3
				CPR350 – AN ⁷	–	3	3
400	298	400	400	CP400 – AN ⁷	CP400 – AA ^{7, 9}	3	3
				CPR400 – AN ⁷	–	3	3
300	224	300	300	C300 – AN	C300A – AA ⁹	3	3
350	261	350	350	C350 – AN	C350A – AA ⁹	3	3
400	298	400	400	C400 – AN	C400A – AA ⁹	3	3
450	336	450	450	C450 – AN	C450A – AA ⁹	3	3
500	373	500	500	C500 – AN	C500A – AA ⁹	3	3
600	448	600	600	C600 – AN	C600A – AA ⁹	3	3

Language Group

Description	Used With . . .	Option Code
Language ⁵	All Drives	
English		-EN
French		-FR
German		-DE
Italian		-IT
Japanese		-JP
Spanish		-ES

Dynamic Brake Kits

Description	Used With . . .	Catalog Number Complete Brake	Catalog Number Brake Chopper
for 200-240V AC Drives	0.37-3.7 kW (0.5-5 HP) ⁶	-KA005	-WA018
	5.5-7.5 kW (7.5-10 HP) ⁶	-KA010	-WA018
	11-22 kW (15-30 HP) ⁶	NA	-WA070
	30-56 kW (40-75 HP) ⁶	NA	-WA115
for 380-480V AC Drives	0.37-3.7 kW (0.5-5 HP) ⁶	-KB005	-WB009
	5.5-7.5 kW (7.5-10 HP) ⁶	-KB010	-WB009
	11-37 kW (15-50 HP) ⁶	-KB050	-WB035
	45-149 kW (60-200 HP) ⁶	NA	-WB110
for 500-600V AC Drives	0.37-3.7 kW (0.5-5 HP) ⁶	-KC005	-WC009
	5.5-7.5 kW (7.5-10 HP) ⁶	-KC010	-WC009
	11-30 kW (15-40 HP) ⁶	-KC050	-WC035
	37-149 kW (50-200 HP) ⁶	NA	-WC085

¹ Drive rating is based on nominal voltage and carrier frequency at altitudes of 1000 meters or less. Refer to the Derating Guidelines on Pages 57-61.

² VT /HP ratings are valid for 240V or 480V only.

³ Not available in this rating.

⁴ 480 Volts only.

⁵ A Language Group must be specified with each drive for User Manual.

⁶ Multiple kits may be utilized together to obtain higher ratings. Refer to the appropriate brake publication (1336-5.64 or 5.65) for further information.

⁷ A "Common Mode Choke" option (-CM) or "No Common Mode Choke" option (-NCM) must be specified with each F Frame Drive.

⁸ These units include as standard an integral EMC filter.

⁹ This drive will not accept a "Snap-In" HIM (HASP, HAS1, HAS2, HCSP, HCS1, HCS2).

1336 PLUS II Selection Guide

Factory Installed Options

Description	Used With . . .	Option Code (Installed)
Communication Options Single Point RIO RS232/422/485, DF1 & DH485 Protocol DeviceNet Enhanced DeviceNet	Frames B & Up (Adapter 6 Only)	-GM1 ³ -GM2 ³ -GM5 ³ -GM6 ³
Communication Options Single Point RIO with Snap-In Cradle RS232/422/485, DF1 & DH485 Protocol w/Snap-In Cradle DeviceNet Enhanced DeviceNet Snap-In Cradle/Blank Plate	All Frames (Adapter 1 Only)	-GMS1 ³ -GMS2 ³ -GMS5 ³ -GMS6 ³ -HASB ³
Control Interface Contact Closure +24V AC/DC 115V AC	All Drives	-L4 -L5 -L6
Control Interface with Encoder Feedback Contact Closure +24V AC/DC 115V AC	All Drives	-L4E -L5E -L6E
Control Interface with Encoder Feedback ⁵ Contact Closure +24V AC/DC 115V AC	All Drives	-L7E -L8E -L9E
Analog Interface – Port A (Choose One) Two Isolated Configurable Inputs One Isolated Bi-Polar Input ($\pm 10V$) and One Isolated Thermistor Input One Isolated Bi-polar Input ($\pm 10V$) and One Isolated Configurable Input	All Drives	-LA2 -LA6 -LA7
Analog Interface – Port B (Choose One) Single-ended, Non-isolated Input Configurable or Pot & 2 Single-ended, Non-isolated 0-20mA Outputs Two Isolated Configurable Outputs One Isolated Configurable Input & Output One Isolated Pulse Input & Non-isolated Output and One Single-ended, Non-isolated 0-10V Output	All Drives	-LA1 -LA3 -LA4 -LA5
Human Interface Module, Snap-In IP20 (NEMA Type 1) Snap-In Cradle/Blank Plate Programmer Only Programmer Only & Upload/Download Capability Programmer/Controller with Analog Pot Programmer/Controller with Analog Pot & Upload/Download Capability Programmer/Controller with Digital Pot Programmer/Controller with Digital Pot & Upload/Download Capability	IP00 (Open) A-G Frame & IP20 (NEMA Type 1) A-D Frame Drives	-HASB -HASP -HCSP -HAS1 -HCS1 -HAS2 -HCS2
Human Interface Module, IP20 (NEMA Type 1) Programmer Only Programmer/Controller with Analog Pot Programmer/Controller with Digital Pot	IP20 (NEMA Type 1) E-G Frame Enclosures	-HAP ² -HA1 ² -HA2 ²
Human Interface Module, IP66 ¹ Programmer/Display Only Programmer/Controller with Digital Pot	IP66 or IP54 (NEMA Type 12) Drives	-HJP -HJ2

¹ This option may be used on an IP65 or IP66 rated enclosure to meet watertight indoor applications.

² Requires a Communication Option Cable (1202-Cxx) to be functional.

³ A maximum of one Communication Option may be ordered factory installed on A Frame drives (2 for B Frame drives and up, limited to 1-Snap-in and 1-Main Control Board mount).

⁴ Each Flex I/O SCANport Module requires (1) 1203-FB1 and (1) 1203-FM1.

⁵ The encoder loss detection feature of the 1336 PLUS II requires the use of L7E, L8E or L9E.

Field Installed Options

Description	Used With . . .	Catalog No. (Loose Kit)
Remote Mounted w/Integral 115V AC Power Supply Single Point RIO RS 232/422/485, DF1, DH485	All Drives	1203-GD1 ² 1203-GD2 ²
Remote Mounted for use with 24V DC Power Supply Single Point RIO RS232/422/485, DF1, DH485 DeviceNet Enhanced DeviceNet	All Drives	1203-GK1 ² 1203-GK2 ² 1203-GK5 ² 1203-GU6 ²
Drive Mounted and Drive Powered (with loose snap-in cradle/blank plate) Single Point RIO RS232/422/485, DF1, DH485 Protocol DeviceNet Enhanced DeviceNet	A Frame Drives – Adapter 1 w/Snap-in Cradle/Blank Plate B Frame & Up – Adapter 6 (or Adapter 1 w/Snap-in Cradle/Blank Plate)	1336-GM1 ³ 1336-GM2 ³ 1336-GM5 ³ 1336-GM6 ^{3,5}
Firmware Download Module Module allows firmware upgrade	All Drives	1336F-FDM
ControlNet™ to SCANport Adapter Remote Mounted (DIN Rail) - 24V DC Requires 24V DC power supply	All Drives	1203-CN1 ^{3,5}
Smart Serial to SCANport Adapter Includes 1203-SFC & 1202-C10 Cables	All Drives	1203-SSS
SCANport Expander Module One to Two One to Four	All Drives	1203-SG2 1203-SG4
Flex I/O SCANport Module ⁴ Flex I/O Terminal Base Flex I/O Module	All Drives	1336-FB1 1336-FM1
HIM, Snap-In, IP20 (NEMA Type 1) Snap-In Cradle/Blank Plate Programmer Only Programmer Only & Upload/Download Capability Programmer/Controller with Analog Pot Programmer/Controller with Analog Pot & Upload/Download Capability Programmer/Controller with Digital Pot Programmer/Controller with Digital Pot & Upload/Download Capability	IP00 (Open) A-G Frame & IP20 (NEMA Type 1) A-D Frame Drives	1201-HASB 1201-HASP 1201-HCSP 1201-HAS1 1201-HCS1 1201-HAS2 1201-HCS2
HIM, Hand-Held, IP20 (NEMA Type 1) Requires Cable Below Programmer Only Programmer/Controller w/Analog Speed Pot Programmer/Controller w/Digital Speed Pot	IP20 (NEMA Type 1) E-G Frame Enclosures	1201-HAP 1201-HA1 1201-HA2
HIM IP66 (NEMA Type 12/UL Type 4X-Indoor) Programmer Only Programmer/Controller w/Digital Speed Pot	IP66 (NEMA Type 12/UL Type 4X Indoor) Enclosures	1201-HJP ² 1201-HJ2 ²
Option Cable Kit - Connect to Comm. Port 0.33 Meters (1.1 Feet) 1 Meter (3.3 Feet) 3 Meter (9.8 Feet) 9 Meter (29.5 Feet)	All HIMs not mounted on the drive chassis	1202-C03 1202-C10 1202-C30 1202-C90
Door Mount Bezel Kit, IP20 (NEMA Type 1)	User Supplied IP20 (NEMA Type 1) Enclosures and HIM	1201-DMA

¹ This option may be used on an IP65 or IP66 rated enclosure to meet watertight indoor applications.

² Requires a Communication Option Cable (1202-Cxx) to be functional.

³ A maximum of one Communication Option may be drive mounted.

⁴ Each Flex I/O SCANport Module requires (1) 1203-FB1 and (1) 1203-FM1.

⁵ Adapter is programmed/configured with Windows™ HyperTerminal via RS-232 using the 1203-SFC cable (purchased separately), or using a compatible network specific software tool.

1336 PLUS II Selection Guide

Notes

1336 PLUS II Standard Packaged Drives Table of Contents



30 HP NEMA TYPE 1 Packaged Drive with Option Enclosure

PRODUCT DESCRIPTION	70
DRIVE SPECIFICATIONS	
Input and Output Ratings	71
Standard AC Line Fusing	72
OPTIONS	
Suggested Power Distribution Schemes	73
Disconnects, Control Transformers, Overload Relays	74
Bypass- Auto, Manual, SMC, Options	75
Multi-pulse Front Ends, Motor Interface	76
Power Conditioning, Control and Feedback, Communication	77
PLC and SLC, Control Interface	78
Human Interface Modules	79
Door Mounted Operator Devices	80
Operator Device Functionality, Meter Options, Enclosure Options ..	81
Codes and Standards, Drawing and Test Options, Firmware	82
ENCLOSURE SPECIFICATIONS	
Installation Guidelines, Enclosure Types (NEMA/IEC)	83
Material Specifications	84
Mounting and Spacing Requirements	85
DIMENSIONS	
NEMA Type 1 (IP20), A-C Frame Drives	86
NEMA Type 4 & 12 (IP65 & IP54), A-C Frame Drives	87
NEMA Type 1 & 12 (IP20 & IP54), D-E Frame Drives	88
NEMA Type 1 & 12 (IP20 & IP54), F Frame Drives	89
NEMA Type 1 & 12 (IP20 & IP54), G Frame Drives	91
PANEL LAYOUTS	
Drive Frame A	93
Drive Frame B	95
Drive Frame C	96
Drive Frame D	98
Drive Frame E	99
Drive Frame F	100
Drive Frame G	101
WIRE TERMINATIONS	
Power Terminal Block TB1	102
Control and Signal Wiring Terminal Block TB2	103
Control Interface Wiring Terminal Block TB3	104
SELECTION GUIDE	
Catalog Number Definition	105
Thermal Overload Relay Data	109
Heater Element Selection	110
Option Selection Rules	111
DRAWING SAMPLES	112

Product Description

The 1336 PLUS II Standard Packaged Drive Package

The heart of every standard packaged drive is a 1336 PLUS II variable frequency controller.

The packaged drives program provides 1336 PLUS II drives assembled with a much larger offering of factory mounted options than what is normally available with a standard product.

Ratings are provided for 0.37-93 kW (0.5-125 HP) at 230V, 0.37-448 kW (0.5-600 HP) at 460V, or 0.75-448 kW (1-600 HP) at 575V. Separate constant torque and variable torque ratings are available for 460V applications.

Packaging

Removable common Human Interface Module.

Provides simplicity of programming and flexibility of operation.

Thermal dissipation management.

Design and extensive infra-red testing minimizes hot spots to maximize reliability.

Modular enclosure.

Design to accommodate a wide variety of drive ratings and option combinations.

IP 20, IP65 & IP54 (NEMA Type 1, 4 & 12) configurations.

Accommodated with "heat sink through the back" design wherever possible.

Standardization

Pre-defined to reduce cost and time.

By using pre-defined, and in most cases pre-engineered, options standardization provides consistency of product offering, resulting in reduced costs, shorter delivery time, and ease of product installation. Even in the case of custom designed drive packages, generally 80% of the engineering already exists.

Drive Specifications

General Specifications

In most cases the general specifications of a standard packaged drive will match those of a stand-alone drive, refer to pages 18 and 19. Some items such as Agency Certification and Maximum Short Circuit Protection will be specific to the options chosen.

Agency Certification

Refer to the Codes and Standards in the Options section

Maximum Short Circuit Drive Package (Current Rating)

The short circuit interrupt capability of any standard packaged drive will be based upon the specific combination of power options chosen

Input and Output Ratings

Each 1336 PLUS II Drive has constant and variable torque capabilities. In the case of 230V and 575V ratings, the constant torque and variable torque ratings will be the same. The listings on this page provide input and output current.¹

230V		Constant Torque			
HP	Cat No.	Input kVA	Input Amps	Output kVA	Output Amps
0.5	AF05C	1.1	2.8	0.9	2.3
0.75	AF07C	1.4	3.5	1.2	3.0
1	AF10C	2.2	5.4	1.8	4.5
1.5	AF15C	2.9	7.3	2.4	6.0
2	AF20C	3.9	9.7	3.2	8.0
3	AF30C	5.7	14.3	4.8	12
5	AF50C	8.5	21.3	7.2	18
7.5	A007C	10-12	28	11	27
10	A010C	12-14	35	14	34
15	A015C	17-20	49	19	48
20	A020C	22-26	63	26	65
25	A025C	26-31	75	31	77
30	A030C	27-33	79	32	80
40	A040C	41-49	119	48	120
50	A050C	52-62	149	60	150
60	A060C	62-74	178	72	180
75	A075C	82-99	238	96	240
100	A100C	100-120	289	116	291
125	A125C	112-134	322	129	325

460V		Constant Torque				Variable Torque					
HP	Cat No.	Input kVA	Input Amps	Output kVA	Output Amps	HP	Cat No.	Input kVA	Input Amps	Output kVA	Output Amps
0.5	BF05C	0.9-1	1.3	0.9	1.1	0.5	BF05V	0.9-1.1	1.4	1	1.2
0.75	BF07C	1.3-1.6	2	1.3	1.6	0.75	BF07V	1.4-1.7	2.1	1.4	1.7
1	BF10C	1.6-2	2.8	1.6	2.1	1	BF10V	1.8-2.2	2.8	1.8	2.3
1.5	BF15C	2.2-2.6	3.3	2.2	2.8	1.5	BF15V	2.3-2.8	3.5	2.4	3
2	BF20C	3.0-3.7	4.6	3	3.8	2	BF20V	3.2-3.8	4.8	3.2	4
3	BF30C	4.2-5.1	6.4	4.2	5.3	3	BF30V	4.7-5.7	7.2	4.8	6
5	BF50C	6.6-8	10	6.7	8.4	5	BF50V	7.0-8.5	10.7	7.2	9
7.5	B007C	8-11	13	10	12.5	7.5	BX007V	8-11	13	10	12.5
7.5	BF75C	9.5-11.6	14.5	11.2	14	7.5	BF75V	12.2-14.7	18.5	13.9	17.5
10	B010C	11-14	17	13	16.1	10	B007V	9-12	14	11	14
10	BF100C	12.2-14.7	18.5	13.9	17.5	10	BF100V	17.1-20.7	26	19.9	25
15	B015C	16-21	25	19	24.2	15	B010V	14-18	22	17	21
20	B020C	21-26	32	25	31	20	B015V	18-23	28	22	27
25	B025C	26-33	40	31	39	25	B020V	23-29	35	27	34
30	B030C	30-38	46	36	45	30	B030V	32-41	49	38	48
40	BX040C	40-50	61	47	59	40	BX040V	40-50	61	47	59
50	B050C	48-60	73	60	75	50	B040V	41-52	63	52	65
60 ²	BX060C	62	75	61	77	60	BX060V	62	75	61	77
60	B060C	54-68	82	68	85	75	B060V	61-77	93	76	96
75	B075C	69-87	105	84	106	100	B075V	78-99	119	96	120
100	B100C	90-114	137	110	138	125	B100V	98-124	149	120	150
125	B125C	113-143	172	138	173	150	B125V	117-148	178	143	180
150	BX150C	148	178	143	180	200	B150V	157-198	238	191	240
150	B150C	130-164	197	159	199	250	B200V	191-241	290	233	292
200	B200C	172-217	261	210	263	250	B250V	212-268	322	259	325
250	B250C	212-268	322	259	325	300	BX250V	228-288	347	279	360
250	BP250C	212-268	322	259	325	300	BP250V	235-297	357	287	360
300	B300C	228-288	347	279	360	350	B300V	261-330	397	319	425
300	BP300C	235-297	357	287	360	350	BP300V	277-350	421	339	425
350	B350C	261-330	397	319	425	400	B350V	294-371	446	359	475
350	BP350C	277-350	421	339	425	400	BP350V	310-392	471	378	475
400	B400C	294-371	446	359	475	450	B400V	326-412	496	398	525
400	BP400C	310-392	471	378	475	450	BP400V	347-438	527	424	532
450	B450C	326-412	496	398	525	500	B450V	372-470	565	454	590
450	BP450C	347-438	527	424	532	600	B500V	437-552	664	534	670
500	B500C	372-470	565	454	590						
600	B600C	437-552	664	534	670						

575V		Constant Torque			
HP	Cat No.	Input kVA	Input Amps	Output kVA	Output Amps
1	CF10C	2.1-2.5	2.4	2.1	2
2	CF20C	4.2-5	4.8	4.2	4
3	CF30C	6.2-7.5	7.2	6.2	6
5	CF50C	8.3-10	9.6	8.3	8
7.5	C007C	9-11	10	10	10
10	C010C	11-13	12	12	12
15	C015C	17-20	19	19	19
20	C020C	21-26	25	24	24
25	C025C	27-32	31	30	30
30	C030C	31-37	36	35	35
40	C040C	38-45	44	45	45
50	C050C	48-57	55	57	57
60	C060C	52-62	60	62	62
75	C075C	73-88	84	85	85
100	C100C	94-112	108	109	109
125	C125C	118-142	137	137	138
150	C150C	144-173	167	167	168
200	C200C	216-260	250	252	252
250	C250C	244-293	282	283	384
300	CX300C	256-307	295	297	300
300	C300C	258-309	297	299	300
350	C350C	301-361	347	349	350
400	C400C	343-412	397	398	400
450	C450C	386-464	446	448	450
500	C500C	429-515	496	498	500
600	C600C	515-618	595	598	600

¹ Drive ratings are at nominal values. Refer to the Drive Derating Guidelines in the Standard Drives section.

² 480V only.

Drive Specifications

Standard AC Line Fusing

Drive input fuses are supplied as standard when required ¹. The fuses provide branch circuit protection for the drive. Generally fuses and fuse blocks are supplied. F frame drives will have the fuses mounted internally to the drive itself. If a Drive Disconnect Switch option is supplied, the fuses will be resident on that switch (except F frame drives). Packaged drives may have different input fuse ratings than those recommended for equivalent standard 1336 PLUS II drives. This is because packaged drives are rated for a single input voltage as opposed to the voltage range of a standard product.

Drive Rating and Catalog Number

230V AC HP	230V AC Cat No.	460V AC-CT HP	460V AC-CT Cat No.	460V AC-VT HP	460V AC-VT Cat No.	575V AC HP	575V AC Cat No.	Fuse Description	Quantity Required	Vendor Part Number
—	—	0.5-0.75	BF05C, BF07C	0.5-0.75	BF05V, BF07V	1	CF10C	3A	3	Bussmann LPJ-3
0.5-0.75	AF05C-AF07C	1-1.5	BF10C, BF15C	1-1.5	BF10V, BF15V	2	CF20C	6A	3	Bussmann LPJ-6
1	AF10C	2	BF20C	2	BF20V	3	CF30C	10A	3	Bussmann LPJ-10
1.5-2	AF15C-AF20C	3	BF30C	3	BF30V	5-7.5	CF50C, CF75C	15A	3	Bussmann LPJ-15
—	—	5-7.5 (14A)	BF50C, BF75C	5, 10 (17.5A)	BF50V, BF75V	10	CF100C	20A	3	Bussmann LPJ-20
3	AF30C	—	—	—	—	15	CF150C	25A	3	Bussmann LPJ-25
—	—	10 (17.5A)	BF100C	15 (25A)	BF100V	20	CF200C	30A	3	Bussmann LPJ-30
—	—	15	BF150C(24A), BF200C	20	BF200V	—	—	35A	3	Bussmann LPJ-35
5	AF50C	—	—	—	—	—	—	40A	3	Bussmann LPJ-40
—	—	15	B015C	—	—	—	—	35A	3	Bussmann JKS-35
7.5	A007C	—	—	—	—	25	C025C	40A	3	Bussmann JKS-40
—	—	20	B020C	25	B020V	—	—	45A	3	Bussmann JKS-45
10	A010C	—	—	—	—	30	C030C	50A	3	Bussmann JKS-50
—	—	25	B025C	—	—	40	C040C	60A	3	Bussmann JKS-60
15	A015C	30	B030C	30	B030V	—	—	70A	3	Bussmann JKS-70
—	—	40	BX040C	40-50	BX040V, B040V	50	C050C	80A	3	Bussmann JKS-80
—	—	—	—	—	—	60	C060C	90A	3	Bussmann JKS-90
20-25	A020C-A025C	50-60	B050C, BX060C	60	BX060V	—	—	100A	3	Bussmann JKS-100
—	—	—	—	—	—	75	C075C	110A	3	Bussmann JKS-110
30	A030C	60	B060C	75	B060V	—	—	125A	3	Bussmann JKS-125
40	A040C	75	B075C	100	B075V	100	C100C	150A	3	Bussmann JKS-150
—	—	—	—	—	—	125	C125C	175A	3	Bussmann JKS-175
50	A050C	100	B100C	125	B100V	—	—	200A	3	Bussmann JKS-200
—	—	—	—	—	—	150	C150C	225A	3	Bussmann JKS-225
60	A060C	125-150	B125C, B150C	150	B125V	—	—	250A	3	Bussmann JKS-250
75	A075C	150	B150C	200	B150V	—	—	300A	3	Bussmann JKS-300
—	—	—	—	—	—	200	C200C	350A	3	Bussmann JKS-350
100	A100C	200	B200C	250	B200V	250-300	C250C, CX300C	400A	3	Bussmann JKS-400
—	—	—	—	—	—	300	C300C	400A	3	Gould A2-70C400AT
125	A125C	250	B250C	250	B250V	—	—	450A	3	Bussmann JKS-450
—	—	300	B300C	300-350	BX250V, B300V	350	C350C	450A	3	Gould A3-70C450AT
—	—	250	BP250C	300	BP250V	—	—	450A	3	Gould A70QS-450
—	—	350	B350C	400	B350V	400	C400C	500A	3	Gould A3-70C500AT
—	—	300	BP300C	350	BP300V	—	—	500A	3	Gould A70QS-500
—	—	400	B400C	450	B400V	450	C450C	600A	3	Gould A3-70C600AT
—	—	350-400	BP350C, BP400C	400	BP350V	—	—	600A	3	Gould A70QS-600
—	—	450	BP450C	450	BP400V	—	—	700A	3	Gould A70QS-700
—	—	450-500	B450C, B500C	500-600	B450V, B500V	500-600	C500C, C600C	800A	3	Gould A3-70C800AT
—	—	600	B600C	—	—	—	—	900A	3	Gould A3-70C900AT

¹ Drive input fuses are not supplied with the circuit breaker option (-CB) for Frames A-E.

Suggested Power Distribution Schemes

The power distribution schemes shown below are for typical configurations and offered as suggestions only. Actual specified configurations may vary with accepted design practices or code restrictions.

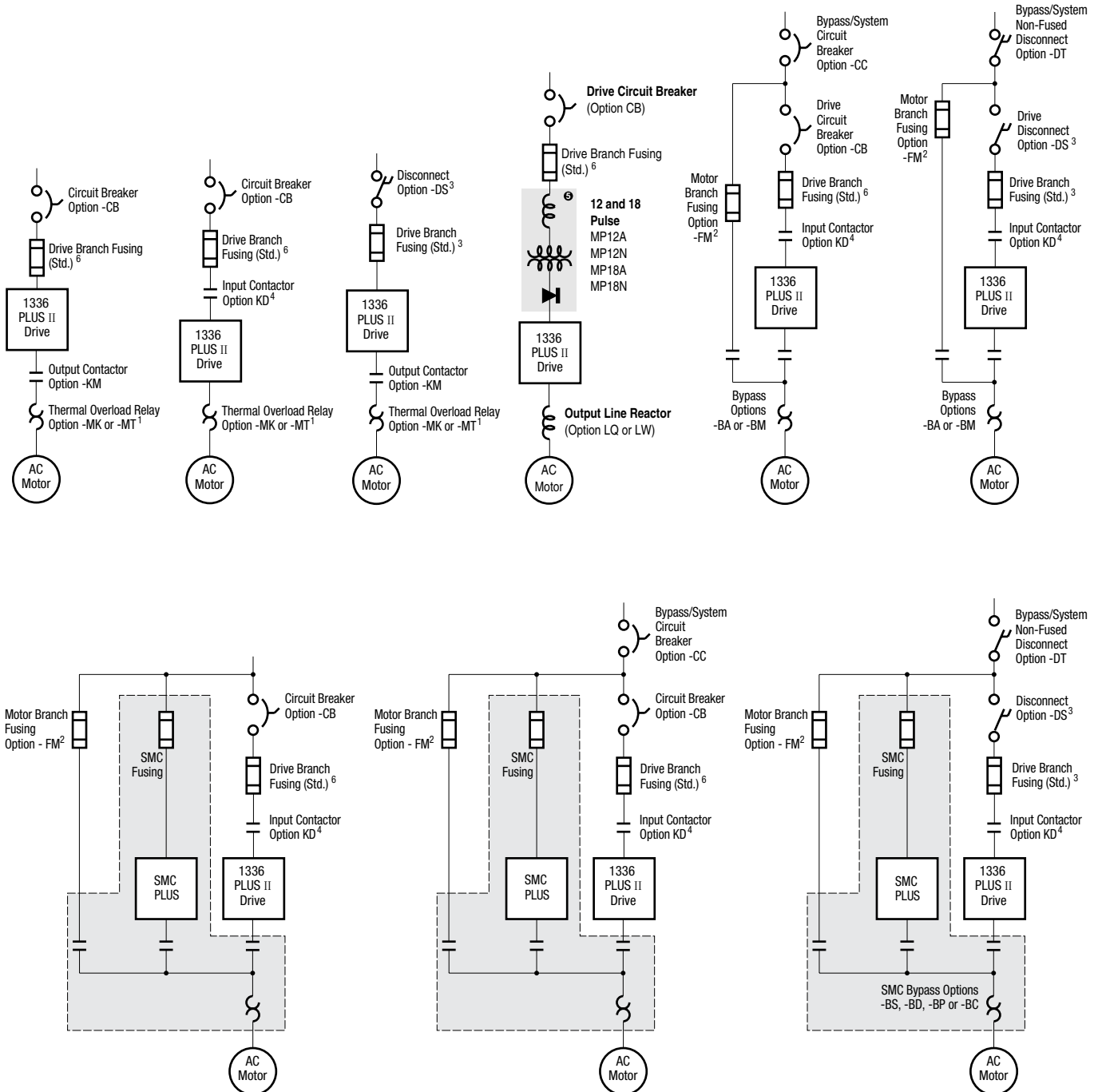

¹ This option is redundant to the existing electronic overload protection supplied by the drive as standard.

² If the motor branch fusing option (-FM) or the bypass/system circuit breaker option (-CC) are not specified, the user must supply motor branch circuit protection.

³ Standard drive branch fusing will be located on the optional drive disconnect switch, if supplied (except F and G Frame drives).

⁴ For F Frame drive ratings – the input contactor option will be located ahead of the internal drive branch fusing.

⁵ Line reactor is standard on -MP12A and -MP18A only.

⁶ Drive branch fusing is standard for Frames F, G and H only.

Options

Power Disconnect Options

Drive Input Fuses (Standard)	This is a standard feature of all packaged drive assemblies except for frames A-E with the circuit breaker option (-CB). These fuses provide branch circuit protection in the drive mode of operation. If a bypass option is included, then separate branch circuit protection may be supplied by the customer or by specifying option -FM. Refer to AC Line Fusing in the Drive Specifications section for specific fuse rating information.
Drive Circuit Breaker (Option CB)	This option provides branch circuit protection for frames A-E and is for disconnecting power only for frames F, G & H. Standard drive input fuses (see above) supply branch circuit protection for frames F, G & H. Most ratings will utilize a motor circuit protector (MCP) type breaker. Where MCP's are not available a molded case switch will be provided. All switches include handle operators, door interlocking and are padlockable. Thermal magnetic type breakers are not required since this type of protection is already supplied in the drive.
Drive Disconnect Switch (Option DS)	An Allen-Bradley Bulletin 194R rotary switch is provided on A-C frame drives. A flange mount or rotary style switch (1494 F where possible) is provided on D frame drives and larger. With the exception of the F frame drive, the drive input fuses will be resident on the switch, allowing it to meet the requirements for branch circuit protection. All disconnect switches are door interlocked and padlockable.
Drive Input Contactor (Option KD)	An Allen-Bradley Bulletin 100 contactor (where available) is provided between the AC line and the drive. The contactor will close on power up using A-B circuitry, or may be alternately controlled by customer supplied remote contact closure logic.
Drive Output Contactor (Option KM)	An Allen-Bradley Bulletin 100 contactor (where available) is provided between the drive output and the motor. The contactor will close on power up, and open after a drive fault or loss of power.

Control Power Options

Drive Only Control Power (Option CF)	Provides a control power transformer mounted and wired inside the drive enclosure. The transformer is rated for drive and options power only. There is no additional capacity for customer use.
Drive Plus 250VA Control Power (Option CP)	This option provides a control power transformer mounted and wired inside the drive enclosure. The transformer is rated for drive power plus an additional 250VA at 120V AC for customer use.
Drive Plus 500VA Control Power (Option CT)	This option provides a control power transformer mounted and wired inside the drive enclosure. The transformer is rated for drive power plus an additional 500VA at 120V AC for customer use.

Thermal Overload Relay Options

Class 10 Motor Thermal Overload Relay (Option MT)	This option provides an Allen-Bradley Bulletin 193 bi-metallic thermal overload relay. The 193 contains an integral heater element with an adjustable trip setting – refer to Motor Thermal Overload Relay Selection in the Selection Guide section. No additional heater elements are required. A Class 10 overload relay will trip in 10 seconds or less at 600% of motor current setting. The motor overload protection provided by this option is redundant to the electronic overload protection provided by the drive itself.
Class 20 Motor Thermal Overload Relay (Option MK)	This option provides an Allen-Bradley Bulletin 592 thermal overload relay. The Bulletin 592 contains a manual reset and requires a eutectic alloy heater element – refer to Heater Element Selection in the Selection Guide section. The heater element is not supplied with this option because specific motor data generally is not known. A Class 20 overload relay will trip in 20 seconds or less at 600% of motor current setting. The motor overload protection provided by this option is redundant to the electronic overload protection provided by the drive itself.

Bypass Options

Where system downtime cannot be tolerated, a bypass option can be provided to allow the motor to run at base speed by operating across the line.

Manual Bypass 1, 2, 3 (Option BM)	This option provides a means to manually switch a single motor from drive control to bypass (across the line) operation. Separate Bulletin 100 (where available) contactors are provided for drive output and bypass operation, and are electrically interlocked. A Bulletin 193 Class 10 overload is also provided for motor protection while operating in the bypass mode – refer to Motor Thermal Overload Data in the Selection Guide section. A door-mounted “Drive/Off/Bypass” selector switch is provided. Optional “Drive Mode” and “Bypass Mode” pilot lights are available (option D41).
---	--

Bypass Options (continued)

Automatic Bypass^{1, 2, 3} (Option BA)

This option provides a means to manually or automatically (upon a drive fault) switch a single motor from drive control to bypass (across the line) operation. Separate Bulletin 100 (where available) contactors are provided for drive output and bypass operation, and are electrically interlocked. A Bulletin 193 Class 10 overload is also provided for motor protection while operating in the bypass mode – refer to Motor Thermal Overload Data in the Selection Guide section. Door-mounted “Drive/Off/Bypass” and “Auto Bypass Off/On” selector switches are provided. Optional “Bypass Mode” and “Auto Bypass Enable On” pilot lights are available (option D42).

Manual Bypass with SMC Plus^{1, 2, 3} (Option BS)

This option provides a means to manually switch a single motor from drive control to bypass (across the line) operation. An SMC Plus™ solid state controller provides soft start capability when first switching to bypass operation. Separate Bulletin 100 (where available) contactors are provided for drive output, SMC output and total bypass. All contactors are electrically interlocked. A door-mounted “Drive/Off/Bypass” selector switch is provided. Optional “Drive Mode” and “Bypass Mode” pilot lights are available (option D41).

Automatic Bypass with SMC Plus^{1, 2, 3} (Option BD)

This option provides a means to manually or automatically (upon a drive fault) switch a single motor from drive control to bypass (across the line) operation. An SMC Plus solid state controller provides soft start capability when first switching to bypass operation. Separate Bulletin 100 (where available) contactors are provided for drive output, SMC output and total bypass. All contactors are electrically interlocked. Door-mounted “Drive/Off/Bypass” and “Auto Bypass Off/On” selector switches are provided. Optional “Bypass Mode” and “Auto Bypass Enable On” pilot lights are available (option D42).

Manual Bypass with SMC Plus / Pump Option^{1, 2, 3} (Option BP)

This option provides a means to manually switch a single motor from drive control to bypass (across the line) operation. An SMC Plus (with the pump control option) solid state controller provides soft start and smooth acceleration capability when first switching to bypass operation and smooth deceleration when stopping in bypass. Separate Bulletin 100 (where available) contactors are provided for drive output, SMC output and total bypass. All contactors are electrically interlocked. A door-mounted “Drive/Off/Bypass” selector switch is provided. Optional “Drive Mode” and “Bypass Mode” pilot lights are available (option D41).

Automatic Bypass with SMC Plus/ Pump Option^{1, 2, 3} (Option BC)

This option provides a means to manually or automatically (upon a drive fault) switch a single motor from drive control to bypass (across the line) operation. An SMC Plus (with the pump control option) solid state controller provides soft start and smooth acceleration capability when first switching to bypass operation and smooth deceleration when stopping in bypass. Separate Bulletin 100 (where available) contactors are provided for drive output, SMC output and total bypass. All contactors are electrically interlocked. Door-mounted “Drive/Off/Bypass” and “Auto Bypass Off/On” selector switches are provided. Optional “Bypass Mode” and “Auto Bypass Enable On” pilot lights are available (option D42).

Bypass Mode Circuit Breaker (Option CC)

This option is for disconnecting power only, and is not intended for branch circuit protection. Branch circuit protection is provided by the bypass fusing option -FM. Most ratings will utilize a motor circuit protector (MCP) type breaker. Where MCP's are not available a circuit breaker will be provided. All switches include handle operators, door interlocking and are padlockable.

Bypass Mode Non-Fused Disconnect Switch (Option DT)

This option is for disconnecting power only, and is not intended for branch circuit protection. Branch circuit protection is provided by the bypass fusing option -FM. An Allen-Bradley Bulletin 194R rotary switch is provided on A-C frame drives. A flange mount or rotary style switch (1494 F where possible) is provided on D frame drives and larger. All disconnect switches are non-fusible, door interlocked and padlockable.

Bypass Mode Motor Fuse Block (Option FM)

This option provides a fuse block only. Fuses must be customer supplied and installed. This option is used in conjunction with any bypass option for motor branch circuit protection.

¹ The Bypass Operation capability provided by this option is **not** intended for maintenance of the drive or entry into the enclosure with power applied while operating in the bypass mode. Maintenance Bypass (positive lockout) is available as a custom option.

² Bypass Options do not include the required 120V AC control power. Control power may be supplied remotely by the user, or as part of the drive package by ordering a Control Power option CF, CP or CT – see Options section.

³ SMC style bypass options will include short circuit fusing for the SMC. Once the motor is up to speed it is transferred from the SMC control to total across-the-line operation, which required option FM to have branch circuit protection.

Options

Multi-Pulse Harmonic Mitigation Option

This 1336 PLUS II drive may be quoted with a multi-pulse front end option for use in harmonic mitigation. This feature reduces drive harmonics at the drive input that could be reflected back to the power distribution system. Excessive harmonics can cause component overheating, nuisance tripping and noise transfer to other load surfaces. The hardware supplied with this option will include line fusing, phase shifting input transformer and an AC to DC diode type converter bridge. The traditional AC fed 1336 PLUS II drive will be replaced by a DC common bus equivalent.

Guidelines for Harmonic Specification IEEE519-1992

This is a North American standard developed from input provided by utilities, electrical equipment manufacturers and power consumers. Total harmonic distortion limits are recommended based upon the type of installation. **Important: For compliance to this standard refer to the description in the specific option detailed below. For more information on harmonic mitigation and the IEEE519-1992 standard refer to publication Drives-BR007A-EN-P.**

12 Pulse Front End with Auto Transformer (Option MP12A)	This option provides a 12 pulse drive front end fed by a 12 pulse auto transformer. It does not guarantee meeting the guidelines of harmonic specification IEEE519-1992 without a detailed harmonic analysis.
12 Pulse Front End with Isolation Transformer (Option MP12N)	This option provides a 12 pulse drive front end fed by a 12 pulse isolation transformer. It does not guarantee meeting the guidelines of harmonic specification IEEE519-1992 without a detailed harmonic analysis.
18 Pulse Front End with Auto Transformer (Option MP18A)	This option provides an 18 pulse drive front end fed by an 18 pulse auto transformer. It will meet the guidelines of IEEE519-1992 at the drive input terminals provided the input power phases are balanced to within 1%.
18 Pulse Front End with Isolation Transformer (Option MP18N)	This option provides an 18 pulse drive front end fed by an 18 pulse isolation transformer. It will meet the guidelines of IEEE519-1992 at the drive input terminals provided the input power phases are balanced to within 2%.

Motor Interface Options

Blower Motor Starter (Option MB)	This option provides blower motor fusing, an Allen-Bradley Bulletin 100 contactor and an Allen-Bradley Bulletin 193 Class 10 thermal overload relay. The blower starter is electrically interlocked with the drive enable function or the bypass contactor (if bypass is provided and selected). The blower motor will be assumed to be 1 HP unless motor data is supplied with the order.
Motor Heater Control (Option MH) (Option MH2) ⁴	This option provides the drive control circuitry for an existing motor heater. The heater is interlocked with the drive run relay and will be energized whenever the motor is not running. Option includes a white Motor Heater On pilot light mounted on the enclosure door. (Option MH) Customer supplied remote 120VAC/360W power (Option MH2) 120VAC supplied from drive package

RTD Protection Module	This option provides a door-mounted RTD sensing module for over temperature and under temperature protection. Each unit will monitor up to (8) motor mounted RTD's and has (3) output relays for alarm, trip and fault. Customer contacts are rated 5A-250V AC res. (Option N6A) 120 Ohm Nickel RTD (Option N7A) 10 Ohm Copper RTD (Option N8A) 100 Ohm Platinum RTD
------------------------------	--

Power Conditioning Options

NEMA Type 1 Line Reactor ⁵ (Option LR) Input (Option LQ) Output	This option provides an open core line reactor which mounts inside the NEMA Type 1 drive enclosure. This option may require a larger enclosure than the standard. Reactor Specifications: Iron core, 3% impedance, Class H insulation, 115°C rise, copper wound, 50/60 Hz.
NEMA Type 4/12 Line Reactor ⁵ (Option LT) Input (Option LW) Output	This option provides an open core line reactor which mounts inside NEMA Type 4 or 12 drive enclosures. This non-ventilated construction will often require a larger enclosure than the same option in a NEMA-type 1 box. Reactor Specifications: Iron core, 3% impedance, Class H insulation, 115°C rise, copper wound, 50/60 Hz.
Common Mode Choke ⁵ (Option CM)	This option will help reduce the common mode noise at the drive output, and help guard against nuisance tripping of the drive caused by capacitive leakage effects. Capacitive currents are larger at higher PWM frequencies.

Control and Feedback Options

Auxiliary Contacts		Contacts Available	230V AC	460V AC-CT	460V AC-VT	575V AC
(Option JM) Alarm		Figure 1 어어어 어어어	0.5-125 HP	0.5-200 HP	0.5-250 (292A) HP	1-300 HP
(Option JT) At Speed						
(Option JC) Control Power On		Figure 2 어어어 어어어	—	250-600 HP	250 (325A)-600 HP	350-600 HP
(Option JF) Drive Fault						
(Option JR) Drive Run						

Isolated Analog Input (Option N3)

This option provides an isolator for the analog input speed reference to the drive and is mounted and wired in the drive enclosure. The default (as shipped) setting will be to accept a remote 4-20mA input. The isolator may be reconfigured by the user to accept any input signal in the range of 0-256V DC or 0-100mA, with or without offset and optional inverse operation. **This option is generally required when both a local speed pot and a remote speed input are utilized.**

Analog Inputs/Outputs ⁷

All isolated I/O are designed with full galvanic isolation. This results in an isolation withstand capability of 200V AC from each channel to True Earth (TE) ground and between channels.

Analog Interface – Port A (Choose One)

LA2C	Two Isolated Configurable Inputs
LA6C	One Isolated Bi-polar Input ($\pm 10V$ or $\pm 20mA$) and one Isolated Thermistor Input
LA7C	One Isolated Bi-polar Input ($\pm 10V$) and One Isolated Configurable Input

Analog Interface – Port B (Choose One)

LA1C	Single-ended, Non-isolated Configurable or Pot & 2 Single-ended, Non-isolated Outputs (1-Configurable, 1-20mA)
LA3C	Two Isolated Configurable Outputs
LA4C	One Isolated Configurable Input & Output
LA5C	One Isolated Pulse Input & Output and One Single-ended, Non-isolated Configurable Output

3-15 PSI Transducer (Local) Feedback (Option N4C) Speed Command (Option N4T) Speed Trim

This option provides a 4-wire, 3-15 PSI transducer mounted inside the enclosure. The transducer accepts air pressure only with a 1/4" NPT fitting and generates an isolated output of 4-20mA proportional to the input pressure. The 4-20mA signal is fed to the drive as either a speed command or speed trim.

3-15 PSI Transducer (Remote) Feedback (Option N5C) Speed Command (Option N5T) Speed Trim

This option provides a 2-wire, 3-15 PSI transducer as a loose item for remote mounting. The transducer accepts air or fluid pressure with a 1/4" NPT fitting and generates an isolated output of 4-20mA proportional to the input pressure. The 4-20mA signal is fed to the drive as either a speed command or speed trim.

Communication Options

Single Point RIO ^{6, 7} (Option GM1C, GD1C or GMS1C)

RIO communication options provide a single point remote I/O interface board. The board can be configured for 1/4, 1/2, 3/4 or full rack with a baud rate of 57.6, 115, or 230 kBaud. The remote I/O Board may be set up by the user to control drive logic, control speed reference commands, monitor drive status and monitor drive logic.

RS232/422/485, DF1 or DH485 Protocol ^{6, 7} (Option GM2C, GD2C or GMS2C)

Communication interface module

DeviceNet ^{6, 7} (Option GM5C, GMS5C, GM6C, GMS6C or GU6C)

DeviceNet to scanport module

¹ The Bypass Operation capability provided by this option does not allow for maintenance of the drive or entry into the enclosure with power applied while operating in the bypass mode.

² Bypass Options do not include the required 120V AC control power. Control power may be supplied remotely by the user, or as part of the drive package by ordering a Control Power option CF, CP or CT – see Options section.

³ Where branch circuit protection is required in the drive, option FM should be specified – see Options section.

⁴ Requires a control power transformer option CF, CP or CT.

⁵ Contact Allen-Bradley for possible drive enclosure size changes when selecting this option.

⁶ GM Series Options are drive mounted (maximum of one). GD Series Options are panel mounted, and require 120V AC power. GU Series Options are panel mounted and require 24V DC power.

⁷ For more information refer to the Standard Drives section.

Options

PLC and SLC Control Options

PLC Hardware and Mounting^{1,2} (Option JL)

This options provides PLC hardware mounted in the drive or option enclosure.
Option includes a maximum of: 4 Position Rack (1771-A1B)
16 Amp Power Supply (1771-P1)
(no programming included)

SLC 500™ Hardware and Mounting^{1,2} (Option JS)

This options provides SLC 500 hardware mounted in the drive or option enclosure.
Option includes a maximum of: 4 Position Rack (1746-A4)
Power Supply (1746-P1)
(No programming included)

Control Interface Options

All 1336 PLUS II Packaged Drives come with a 115V AC Control Interface Card (Option L6) as standard unless otherwise specified. 24V AC/DC control and Contact Closure control are available as options. Encoder feedback is also available as an option with any of the three control methods.

All control interface cards provide input terminals for access to fixed drive functions that include start, stop, auxiliary fault, line loss, output contactor close, speed select, sync, traverse, reset, and enable. Additional inputs are programmed for functions such as reverse, preset speed access, jog, second accel/decel time access and local control selection. The function of each input is defined through programming. For Packaged Drives, functions are pre-programmed at the factory for a specific application and configuration and should not require field programming.

Operator control devices provided as part of the drive package will be interfaced to these same input terminals. All control input terminals are optically isolated from the drive internal control logic.

Optional encoder feedback is available for use with single-ended or differential type encoders. When using a single ended encoder there is a 12V DC power supply available for customer use. Differential encoders will require a user supplied power supply.

Contact Closure Control Interface³ (Option L4C) Without Encoder Feedback (Option L7EC) With Encoder Feedback

Circuits used with Option L4C or L7EC must be capable of operating with **low = true logic**.
In the low state, external circuits must be capable of a sinking current of approximately 10 mA to pull the terminal voltage low to 3.0V DC or less.
In the high state, external circuits must allow the terminal voltage to rise to a voltage of 4.0-5.0V DC.

Note: Reed type input devices are recommended.

The L4C/L7EC option is compatible with the following Allen-Bradley PLC modules:

- 1771-OYL
- 1771-OZL

+24V AC/DC Control Interface³ (Option L5C) Without Encoder Feedback (Option L8EC) With Encoder Feedback

Circuits used with Option L5C or L8EC must be capable of operating with **high = true logic**.
DC external circuits in the low state must generate a voltage of no more than 8V DC.
Leakage current must be less than 1.5 mA into a 2.5k ohm load.

AC external circuits in the low state must generate a voltage of no more than 10V AC. Leakage current must be less than 2.5 mA into a 2.5k ohm load.

Both AC and DC external circuits in the high state must generate a voltage of +20 to +26 volts and source a current of approximately 10 mA for each input.

The L5C/L8EC option is compatible with the following Allen-Bradley PLC modules:

- 1771-OB
- 1771-OBN
- 1771-OQ16
- 1771-OZL
- 1771-OB16
- 1771-OBD
- 1771-OQ
- 1771-OYL
- 1771-OB

115V AC Control Interface³ (Standard L6 Interface) Without Encoder Feedback (Option L9EC) With Encoder Feedback

Circuits used with the standard L6 interface or Option L9EC must be capable of operating with **high = true logic**.
In the low state, circuits must generate a voltage of no more than 30V AC. Leakage current must be less than 10 mA into a 6.5k ohm load.

In the high state, circuits must generate a voltage of 90-115V AC \pm 10% and source a current of approximately 20 mA for each input.

The L6C/L9EC option is compatible with the following Allen-Bradley PLC modules:

- 1771-OW
- 1771-OWN
- 1771-OA
- 1771-OAD (Contact Factory for Recommended Series/Rev. Level)

¹ Rack size will impact enclosure size. Contact Allen-Bradley for possible enclosure size changes.

² Actual hardware list will be determined at time of order entry.

³ For more information refer to the Standard Drives section.

Human Interface Modules – NEMA Type 1 and 12 Door Mounted HIMS

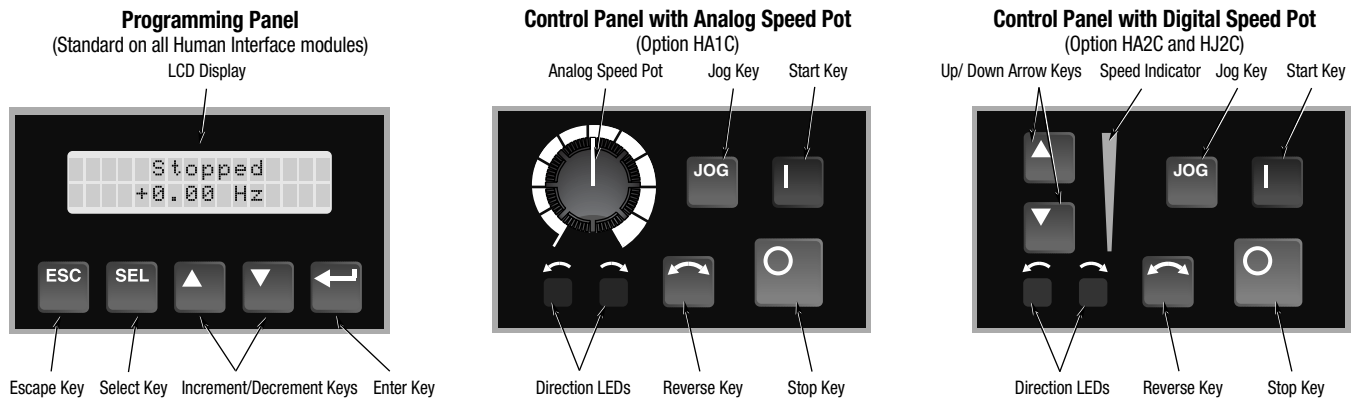

NEMA Type 1 Drive Mounted HIMS

(Option HNSBC)
 (Option HNSPC)
 (Option HNS1C)
 (Option HNS2C)

Blank – No Functionality
 Program Only
 Program/Control with Analog Speed Pot
 Program/Control with Digital Speed Pot

NEMA Type 1 Door Mounted HIMS

(Option HABC)
 (Option HAPC)
 (Option HA1C)
 (Option HA2C)

Blank – No Functionality
 Program Only
 Program/Control with Analog Speed Pot
 Program/Control with Digital Speed Pot

NEMA Type 12 Door Mounted HIMS¹

(Option HJPC)
 (Option HJ2C)

Program Only
 Program/Control with Digital Speed Pot

Handheld

A separate handheld module may be connected to the drive. Maximum cable length is 33 feet (10 meters)

¹ Not removable from the door as with NEMA Type 1 HIMS.

Options

Door-Mounted Operator Devices

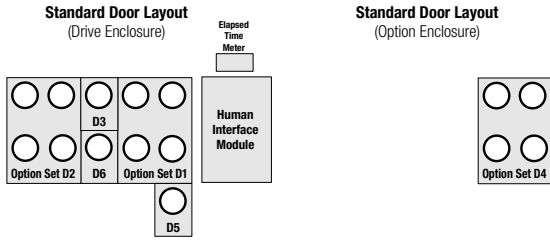

Operator devices specified in the drive catalog number are supplied mounted and wired on the enclosure door. The Standard Door Layouts shown indicate the mounting locations of door mounted options or option groups.

The operator device options listed below are logically grouped into sets. Only one option code selection may be made from each set. Where possible, Allen-Bradley Bulletin 800E style operator devices will be supplied.

Description Code: **PB** = Pushbutton **SS** = Selector Switch
PL = Pilot Light **POT** = Potentiometer
MHPB = Mushroom Head Pushbutton

Legend plates will be 30 mm x 50 mm, black with white lettering.

Option Set D1

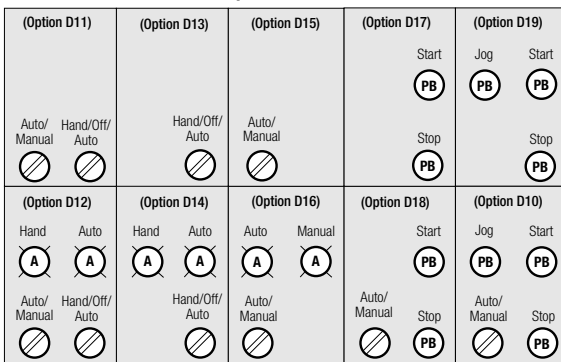

Option Set D1

- (Option D10) Start **PB**, Stop **PB**, Jog **PB**, & Auto/Manual **SS**
- (Option D11)¹ Hand/Off/Auto (start/stop only) **SS** & Auto/Manual (speed reference only) **SS**
- (Option D12)¹ D11 Options plus Hand **PL** & Auto **PL**
- (Option D13)¹ Hand/Off/Auto (start/stop/speed ref.) **SS**
- (Option D14)¹ D13 Option plus Hand **PL** & Auto **PL**
- (Option D15)¹ Auto/Manual (speed reference only) **SS**
- (Option D16)¹ D15 Option plus Auto **PL** & Manual **PL**
- (Option D17) Start **PB** & Stop **PB**
- (Option D18) Start **PB**, Stop **PB** & Auto/Manual **SS**
- (Option D19) Start **PB**, Stop **PB** & Jog **PB**

Option Set D2

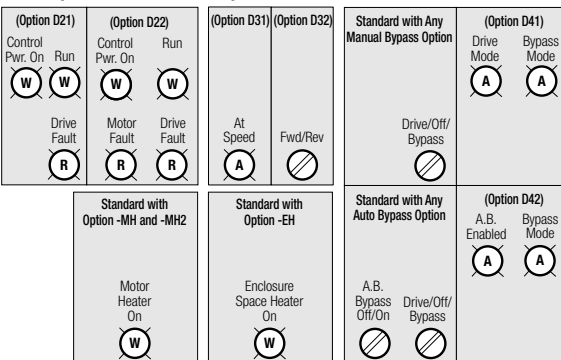

Option Set D2

- (Option D21) Control Power On **PL**, Run **PL** & Drive Fault **PL**
- (Option D22)² D21 Options plus Motor Fault **PL**

Option Set D3

- (Option D31) At Speed **PL**
- (Option D32) Forward/Reverse **SS**

Option Set D4

- (Option D41)³ Drive Mode **PL** & Bypass Mode **PL**
- (Option D42)⁴ Auto Bypass Enabled On **PL** & Bypass Mode **PL**

Option Set D5

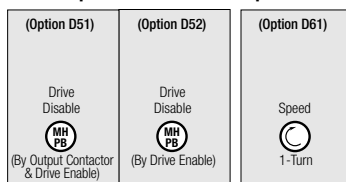

Option Set D5

- Drive Disable (push-pull) **MHPB**
- (Option D51)⁵ For Use with Drive Output Contactor & Drive Enable
- (Option D52)⁶ For Use with Drive Enable Only

Option Set D6

- (Option D61) Speed **POT**, 1-Turn, NEMA Type 1/4/12

¹ Refer to Operator Device Function Guide in the Options section.

² D22 must be used in conjunction with a Thermal Overload or Bypass Option.

³ D41 must be used with a Manual Bypass Option.

⁴ D42 must be used with an Auto Bypass Option.

⁵ D51 must be used in conjunction with an Output Contactor or Bypass Option.

⁶ D52 cannot be used with a Bypass Option.

Option Set D9

- (Option D91) Convert the normally supplied A-B Bulletin 800E Style Operator Devices to A-B Bulletin 800T Style

Operator Device Function Guide

Option	Device Mode	Drive Start Control				Drive Stop Control				Drive Speed Reference		
		Pushbutton or Selector Switch	H.I.M. With Control	Remote Contact	None	Pushbutton or Selector Switch	H.I.M. With Control	Remote Contact	None	H.I.M. Options With Control Parameter #5 = Adapter 1	Defined by Drive Parameter ¹	None
D10	Start/Stop/Jog	•				•						•
	Auto/Manual	•			•	•			•	•	•	
D11 & D12	Hand/Off/Auto	•	•			•	•	•				•
	Auto/Manual				•				•	•	•	
D13 & D14	Hand/Off/Auto	•	•			•	•	•		•		•
	Auto/Manual				•				•	•	•	
D15 & D16	Auto/Manual				•				•	•	•	
					•				•	•	•	

¹ The function of the "Auto Mode" speed reference is dependent upon the programming of [Freq Select 2], parameter 6 in the drive. The use of an Analog Input Card is recommended for any analog signal being fed to the drive. The function of the "Jog" mode is dependent upon the programming of [Jog Freq], parameter 24 in the drive.

Meter Options

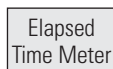
Motor Run Time Meter
(Option ET)

This option provides a digital, non-resettable, door-mounted elapsed time meter. The meter is electrically interlocked with the Drive Run relay and Bypass contactor (if supplied) to indicate actual motor operating hours.

(Note: The standard internal drive elapsed time meter requires a HIM for viewing and is not operable in the bypass mode.)

Line Metering System, Deluxe
(Option MQ2)

This option provides a Powermonitor II unit at the point of incoming power to the drive package. Option includes a powermonitor and a single display. Current transformers are supplied as necessary.

Line Metering System, Basic
(Option MQ3)

This option provides a Powermonitor 3000 unit at the point of incoming power to the drive package. Option includes a powermonitor and a single display. Current transformers are supplied as necessary.

Enclosure Options

Voltage Barriers
(Option EB)

Protective covers for line side of disconnect switch, door-mounted devices above 50V (except for devices with finger safe terminals), and any foreign voltage sources.

Floor Stand
(Option EF1) 12" High
(Option EF2) 24" High

This option converts a wall-mounted enclosure to a floor-mounted enclosure and adds 12" or 24" to the height of the enclosure. Special consideration should be given to the final height of the drive package and corresponding operator devices.

Nameplate
(Option ET)

Pin or screw-mounted 6.25" x 2" door-mounted white lamacoid nameplate with black letters. The message is defined by the customer at order entry – if no definition is supplied, the nameplate is shipped blank for customer engraving.

Special Paint (Option EP1) 1-color,
(Option EP2) 2-color, (Option EP3) 3-color

Special color(s) and/or type of paint. A manufacturer's specification number and/or paint chip will be required at order entry. **(Note:** A special primer specification is considered as one color.)

Space Heater, Remote Powered
(Option EH)

Provides (1) enclosure space heater to help prevent condensation inside the enclosure during periods of drive inactivity. Space heater is energized whenever drive power is removed (requires a remote 120V AC power source). Option includes a 180W fin strip type heater and a white Enclosure Space Heater On pilot light mounted on the enclosure door. If remote power is not available, refer to option EH2.

Space Heater, Locally Powered
(Option EH2) Requires a control
power transformer option CF, CP or CT

Provides (1) enclosure space heater to help prevent condensation inside the enclosure during periods of drive inactivity. Space heater is energized whenever the drive is not in Run status. If the space heater is required to run when drive power is removed refer to option EH

Filtered Door Openings Only
(Option EC)



This option provides washable metal mesh filters on the outside of the enclosure door and over all other vented openings. This option applies only to NEMA Type 1 drives.

Gasketed with Filtered Door Openings
(Option EG)

This option provides filtering as described in option EC. In addition all doors and wall panels will be gasketed as necessary to prevent unfiltered air from entering the enclosure.

Options

Codes and Standards

Code/Standard	Action
CE (European Conference Standard)	 Consult the factory with requirements to meet the separate Low Voltage and/or EMC directives. In most cases Packaged Drives qualify for "Restricted Industrial" applications and will only require meeting the Low Voltage directive.
IEEE519 (Harmonic Distortion Levels)	Provide a one-line plant power distribution drawing, and the associated harmonic specification to the factory, for review. A software-based harmonic analysis will be performed to determine actual harmonic mitigation requirements.
UL, C-UL (CSA)	  Add a "-UL" option to the catalog string at no charge. This option provides UL panel recognition from the factory.

Drawing and Test Options

Approval Drawings Cat. No. 1301-APPDWG (Black & Whites) Cat. No. 1301-APPRV (Velumes)	One set 11" x 17" electrical schematics and enclosure outlines – see sample drawings at the back of this publication. Further engineering and manufacture of drive held until drawings are returned approved by the customer and any changes are approved by the manufacturer.
Manufacturing Drawings Cat. No. 1301-MFDWG (Black & Whites) Cat. No. 1301-MFRV (Velumes)	One set 11" x 17" electrical schematics and enclosure outlines – see sample drawings at the back of this publication. Information Only – Does not affect drive manufacturing. Availability is typically 2-3 weeks prior to shipment of the drive(s).
Final Drawings Cat. No. 1301-FINDWG (Black & Whites) Cat. No. 1301-FINRV (Velumes) Cat. No. 1301-FINRM (Mylar)	One set 11" x 17" electrical schematics and enclosure outlines – see sample drawings at the back of this publication. Same drawings as shipped with the configured drive instruction book
Special Drawings and Reports Cat. No. 1301-TESTR Cat. No. 1301-CERMTR Cat. No. 1301-CERXFR Cat. No. 1301-CERLR Cat. No. 1301-DISK Cat. No. 1301-HARM1 Cat. No. 1301-HARM2 Cat. No. 1301-HARM3 Cat. No. 1301-WT	Test Report, Configured Drive Only – Certifies that the configured drive has gone through test. Certified Motor Dimension Drawing. Certified Transformer Dimension Drawing. Certified Line Reactor Dimension Drawing – Not available if mounted in the drive enclosure. AutoCAD™ Disk copy of order schematics after order has shipped. Basic Harmonic Analysis – Pre-order review of customer's one-line power distribution diagram. Complete Harmonic Analysis – Post order detailed Harmonic Spectrum Analysis followed up with a written report. Deluxe Harmonic Analysis – Post order site verification of actual harmonics, detailed Spectrum Analysis and written report. Witness Test – Customer viewing of A-B standard test procedures only. Additional tests and documentation per customer requirements are also available.

Custom Drive Firmware Options

2 Second Power Loss Fault Delay ¹ (Option EN910)	Implementation of a 2 second power loss fault delay time. The timer is engaged when the [Line Loss Fault] parameter is enabled and bus voltage drops below 85%, but above minimum bus voltage.
MOP Reset On Stop (Option EN935)	MOP frequency source is programmed to reset to zero following a stop.
60 Hertz Maximum Frequency (Option EN945)	Maximum frequency of the drive is limited to 60 Hz.

¹ This option should not be used with other packaged drive options that do not have power fault delay capability.

Installation Guidelines

The information in the remaining sections of this document is very useful in making pre-installation decisions. Consideration should be given to enclosure type (environment), enclosure size (mounting area available and mounting convention), panel layouts (customer wiring connection locations and extra customer mounting area), terminal block descriptions (what connections land where) and catalog number definition (how do I order exactly what I need?).

Pay special attention to all footnotes and carefully read all warnings.



ATTENTION: The following information is merely a guide for proper installation. The Allen-Bradley Company cannot assume responsibility for the compliance or the noncompliance to any code, national, local or otherwise for the proper installation of this drive or associated equipment.

A hazard of personal injury and/or equipment exists if codes are ignored during installation.



ATTENTION: The drive disable circuitry only shuts off the power transistors or opens an output contactor. Both functions disable inherent or optional dynamic braking effects.

If hazards of injury due to contact with moving machinery or unintentional flow of liquid, gas or solids exist, it is the user's responsibility to provide an additional hardwired stop circuit in accordance with applicable codes and standards.

Enclosure Types

Packaged Drives are assembled in NEMA Type 1, 4 or 12 enclosures with the heatsinks mounted out the back wherever possible. G frame drives and certain special NEMA ratings will require internally-mounted heatsinks. Each enclosure type lends itself to a particular type of protection and environment. The enclosures detailed below do not normally protect electrical equipment from condensation, corrosion or contamination which may occur within the enclosure or enter via the conduit or unsealed openings. Users must make adequate provisions to safeguard against such conditions, and satisfy themselves that the equipment is properly protected. Other enclosure types are available by custom quotation. For further information on criteria associated with NEMA enclosure ratings, refer to NEMA Standards **Publication NO. 250-1991**.

IP20 NEMA Type 1

Type 1 enclosures are intended for indoor use primarily to provide a degree of protection against contact with the enclosed equipment in locations where unusual service conditions do not exist. The enclosures are designed to meet the rod entry and rust resistance design tests. Slotted openings in the enclosure sides or door(s) allow for free exchange of inside and outside air.

IP54 NEMA Type 12

Type 12 enclosures are intended for indoor use primarily to provide a degree of protection against dust, falling dirt and dripping non-corrosive liquids. They are designed to meet drip, dust and rust resistance tests. There are no ventilation openings within the enclosure to allow free exchange of inside and outside air. Closed loop auxiliary cooling may be required for higher HP ratings. Specifications calling for NEMA-12 ventilated enclosures should be reviewed with the factory.

IP65 NEMA Type 4

Type 4 enclosures are intended for indoor or outdoor use primarily to provide a degree of protection against windblown dust and rain, splashing water, and hose directed water, and to be undamaged by the formation of ice on the enclosure. They are designed to meet hose-down, dust, external icing and rust resistance design tests. Doors and openings will be gasket sealed. There are no ventilation openings within the enclosure to allow for free exchange of inside and outside air. Closed loop auxiliary cooling may be required for higher HP ratings.

Enclosures Specifications

Material Specifications

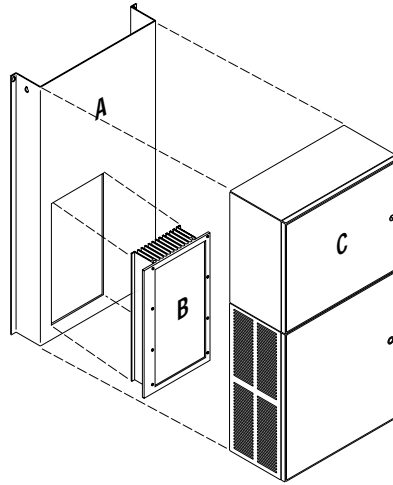

A Back Plate Chassis for Heatsink

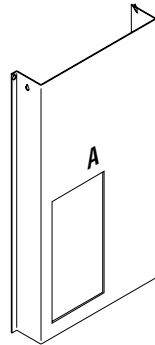

Frame	Material	Finish	Finish Spec.
A1-C	12 GA. Sheet Steel	A-B Standard Light Gray Paint (Low Gloss)	(NEMA Type 1) 40001-109-08 ASA 61 GRAY
		A-B Standard Light Gray Paint (Powder Coat Low Gloss)	(NEMA Type 4/12) 40001-108-04
D-E	12 GA. Sheet Steel	A-B Standard Gray Paint	(NEMA Type 1/12) 40001-109-02 ASA 49 GRAY
F-G	12 GA. Sheet Steel	A-B Standard Gray Paint	(NEMA Type 1/12) 40001-109-02 ASA 49 GRAY

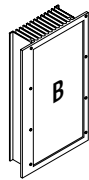

B Heatsink

Frame	Material	Finish	Finish Spec.
A-G	Aluminum	Bronze Chromate	40001-058

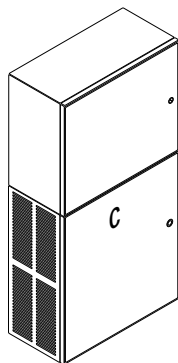

C Enclosure

Frame	Material	Finish	Finish Spec.
A1-C	14 GA. Sheet Steel	A-B Standard Light Gray Paint	(NEMA Type 1) 40001-109-08 ANSI 49 GRAY
			(NEMA Type 4/12) 40001-108-04
D-G	12 GA. Sheet Steel	A-B Standard Light Gray Paint	(NEMA Type 1/12) 40001-109-02 ASA 49 GRAY

Mounting and Spacing Requirements

Approved Mounting Methods for Wall Mounting Enclosures

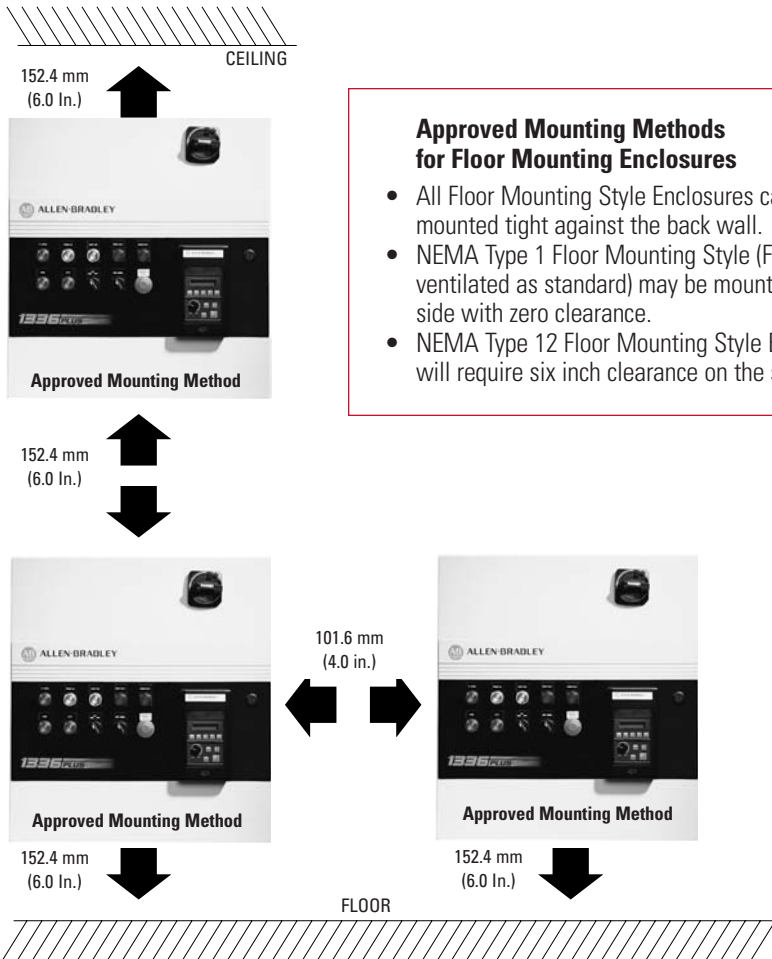

Approved Mounting Methods for Floor Mounting Enclosures

- All Floor Mounting Style Enclosures can be mounted tight against the back wall.
- NEMA Type 1 Floor Mounting Style (Force ventilated as standard) may be mounted side by side with zero clearance.
- NEMA Type 12 Floor Mounting Style Enclosures will require six inch clearance on the sides.

Not Acceptable

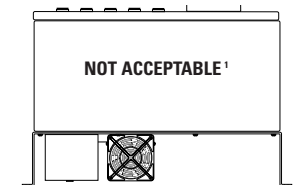
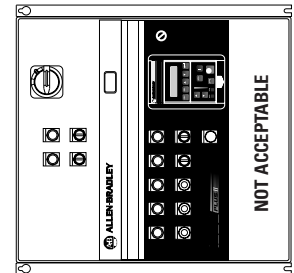

¹ Some horizontal mounting conventions are acceptable provided the application and packaging is reviewed with Allen-Bradley.

Input Conditioning

In general, the 1336 PLUS II drive is suitable for direct connection to a correct voltage AC line that has a minimum impedance of 1% (3% for 0.37-22 kW/0.5-30 HP drives) relative to the rated drive input kVA. If the line has a lower impedance, a line reactor or isolation transformer must be added before the drive to increase line impedance. If the line impedance is too low, transient voltage spikes or interruptions can create excessive current spikes that will cause nuisance input fuse blowing and may cause damage to the drive power structure.

The basic rules for determining if a line reactor or isolation type transformer is required are as follows:

1. If the AC input power system does not have a neutral or one phase referenced to ground (Refer to **Ungrounded Distribution Systems**), an isolation transformer with the neutral of the secondary grounded is highly recommended. If the line-to-ground voltages on any phase can exceed 125% of the nominal line-to-line voltage, an isolation transformer with the neutral of the secondary grounded, is always required.
2. If the AC line supplying the drive has power factor correction capacitors that are switched in and out, an isolation transformer or 5% reactors are recommended between the capacitors and drive. If the capacitors are permanently connected and not switched, the general rules for impedance mismatch above apply.
3. If the AC line frequently experiences transient power interruptions or significant voltage spikes, an isolation transformer or 5% reactors are recommended.

Line reactors and isolation transformers can be ordered as loose items or installed in the drive enclosure.

Dimensions

IP20 (NEMA Type 1) Dimensions For A-C Frame Drives

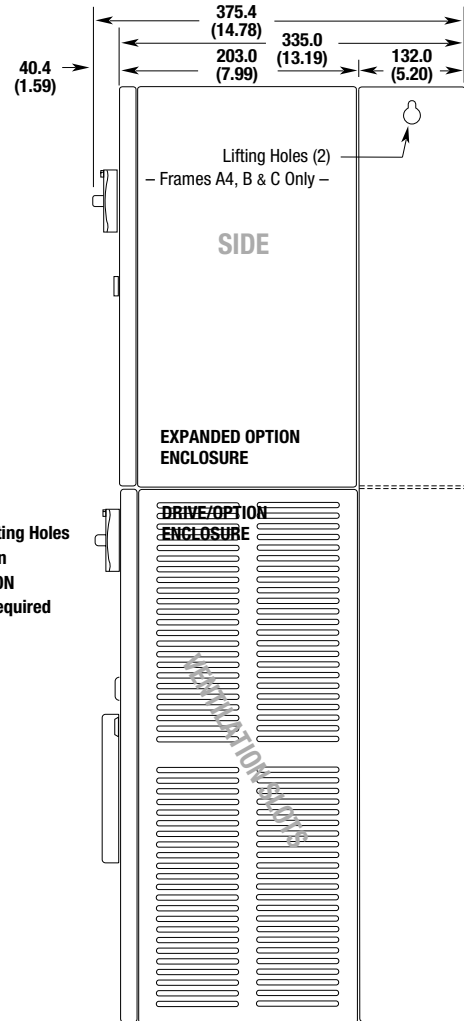
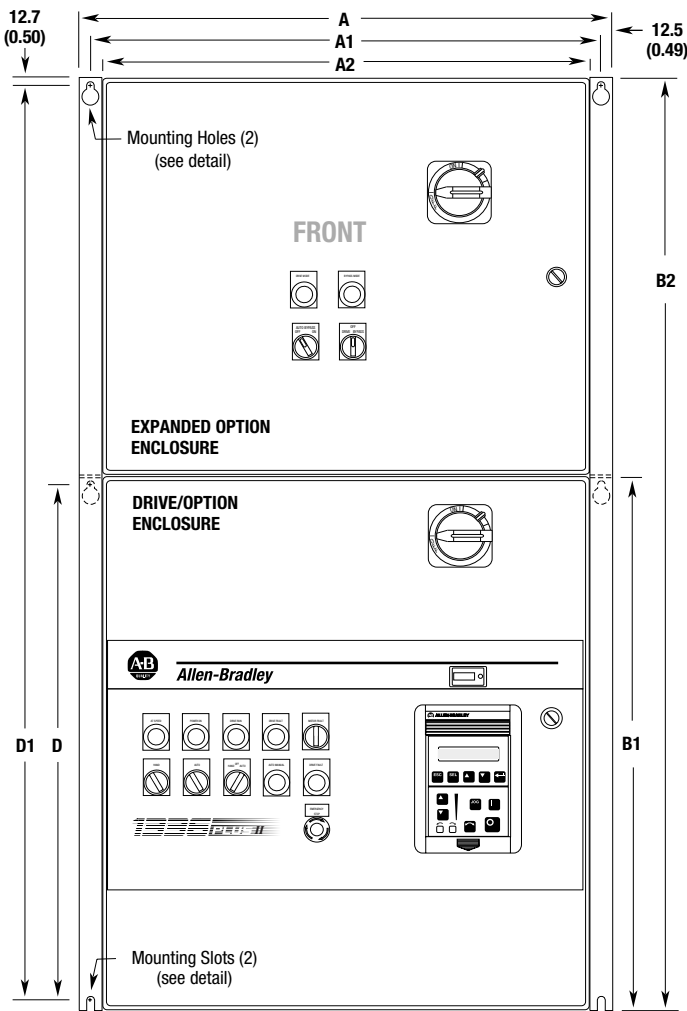

Additional Mounting Holes Not Present When EXPANDED OPTION ENCLOSURE Is Required

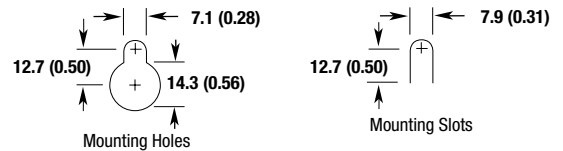
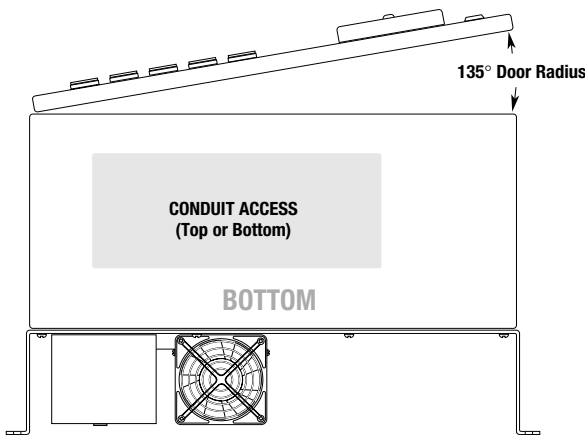

Option Mounting Location

DRIVE/OPTION ENCLOSURE	All Option Codes Not Listed Below
EXPANDED OPTION ENCLOSURE	Option Codes BA, BM, CC, D41, D42, DT, JS
CONSULT FACTORY	Option Codes BC, BD, BP, BS, CM, JL, LQ, LR, MP12A, MP12N, MP18A, MP18N, MQ2, MQ3

Approximate Shipping Weights
All Weights in Kilograms and (Pounds)

Frame	Three-Phase Ratings			All Dimensions in Millimeters and (Inches)							Drive/Option Enclosure Only	Drive/Option and Expanded Option Enclosures
	230V	460V	575V	A	A1	A2	B1	B2	D	D1		
A1-A3	0.37-3.7 kW 0.5-5 HP	0.37-3.7 kW 0.5-5 HP	—	655.0 (25.79)	630.0 (24.80)	600.0 (23.62)	500.0 (19.69)	1000.0 (39.37)	475.0 (18.70)	975.0 (38.39)	35 (75)	65 (140)
A4 or B	5.5-11 kW 7.5-15 HP	5.5-22 kW 7.5-30 HP	0.75-15 kW 1-20 HP	655.0 (25.79)	630.0 (24.80)	600.0 (23.62)	650.0 (25.59)	1150.0 (45.28)	625.0 (24.61)	1125.0 (44.29)	60 (130)	110 (243)
C	15-22 kW 20-30 HP	30-45 kW 40-60 HP	19-45 kW 25-60 HP	855.0 (33.66)	830.0 (32.68)	800.0 (31.50)	900.0 (35.43)	1550.0 (61.02)	875.0 (34.45)	1525.0 (60.04)	95 (210)	145 (320)

IP54 (NEMA Type 12) and IP 65 (NEMA TYPE 4) Dimensions For A-C Frame Drives

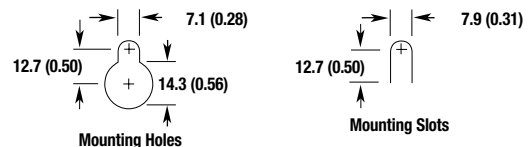
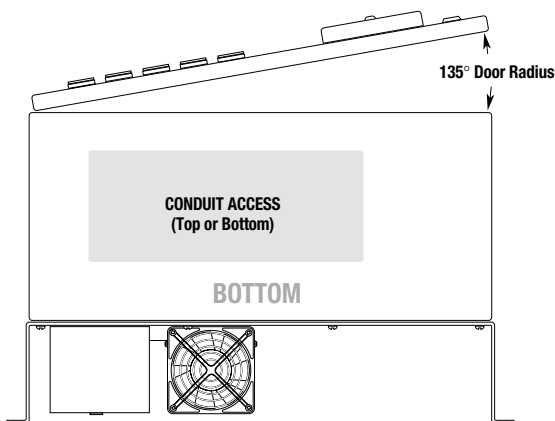
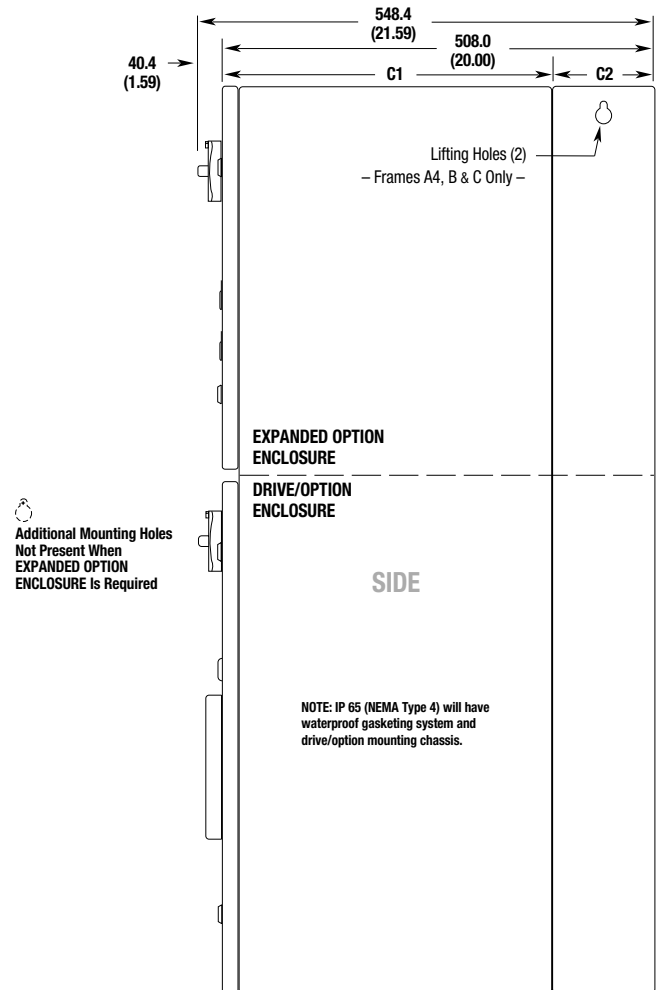
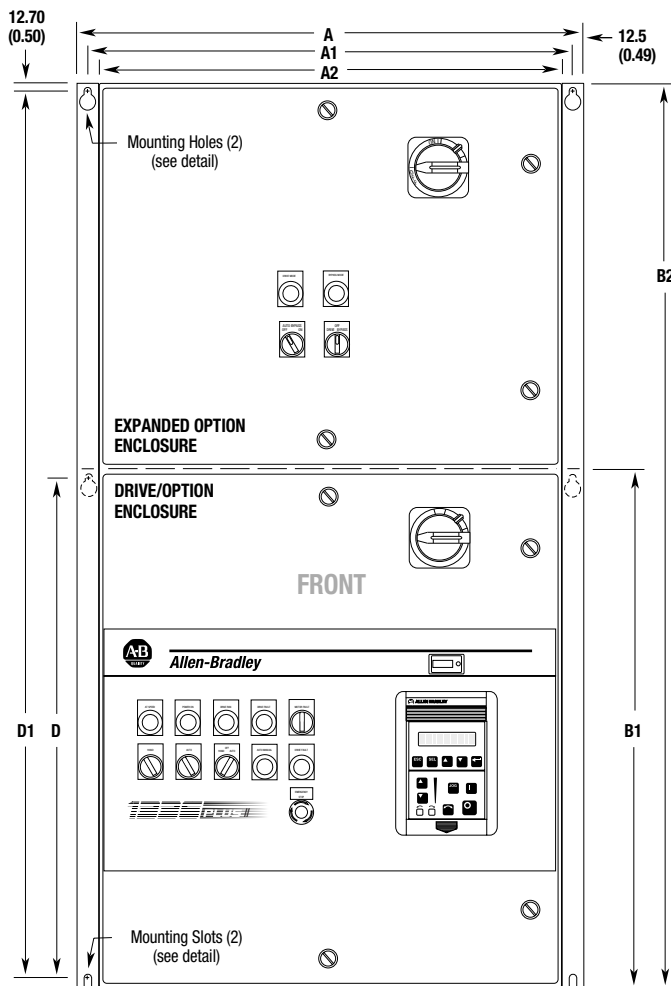

Option Mounting Location

DRIVE/OPTION ENCLOSURE

All Option Codes Not Listed Below

EXPANDED OPTION ENCLOSURE

Option Codes BA, BM, CC, D41, D42, DT, JS

CONSULT FACTORY

Option Codes BC, BD, BP, BS, CM, JL, LQ, LR, MP12A, MP12N, MP18A, MP18N, MQ2, MQ3

Approximate Shipping Weights
All Weights in Kilograms and (Pounds)

Frame	Three-Phase Ratings			All Dimensions in Millimeters and (Inches)								Drive/Option Enclosure Only	Drive/Option and Expanded Option Enclosures	
	230V	460V	575V	A	A1	A2	B1	B2	C1	C2	D			D1
A1-A3	0.37-3.7 kW 0.5-5 HP	0.37-3.7 kW 0.5-5 HP	—	664.7 (26.17)	639.8 (25.19)	609.6 (24.00)	685.8 (27.00)	1193.8 (47.00)	407.9 (16.06)	100.1 (3.94)	660.9 (26.02)	1168.9 (46.02)	50 (110)	79 (175)
A4 or B	5.5-11 kW 7.5-15 HP	5.5-22 kW 7.5-30 HP	0.75-15 kW 1-20 HP	918.7 (36.17)	893.8 (35.19)	863.6 (34.00)	939.8 (37.00)	1549.4 (61.00)	375.9 (14.80)	132.0 (5.20)	914.9 (36.02)	1524.5 (60.02)	77 (170)	129 (285)
C	15-22 kW 20-30 HP	30-45 kW 40-60 HP	19-45 kW 25-60 HP	918.7 (36.17)	893.8 (35.19)	863.6 (34.00)	1320.8 (52.0)	1930.4 (76.0)	375.9 (14.80)	132.0 (5.20)	1295.9 (51.02)	1905.5 (75.02)	116 (255)	166 (365)

Dimensions

IP20 (NEMA Type 1) and IP54 (NEMA Type 12) For D-E Frame Drives

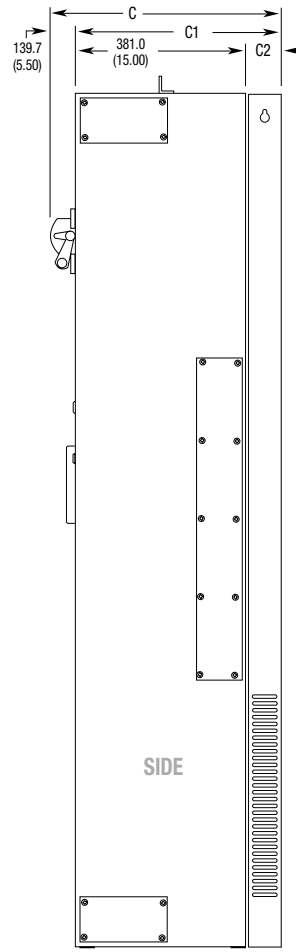
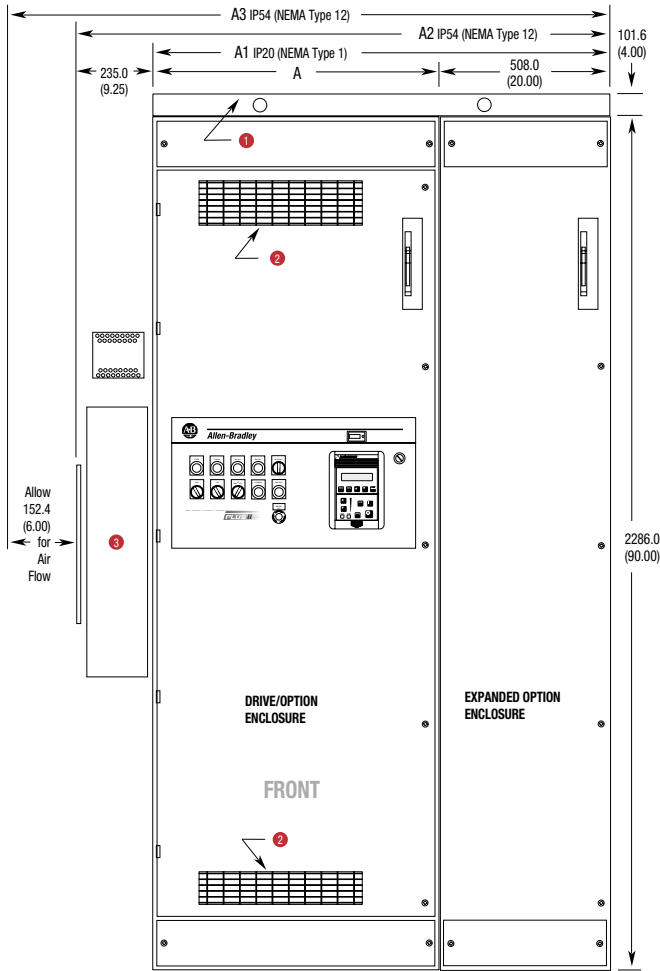

Option Mounting Location

DRIVE/OPTION ENCLOSURE	All Option Codes Not Listed Below
EXPANDED OPTION ENCLOSURE	Option Codes BA, BM, CC, D41, D42, DT and JS
CONSULT FACTORY	Option Codes BC, BD, BP, BS, CM, JL, LQ, LR, LT, LW, MP12A, MP12N, MP18A, MP18N, MQ2 and MQ3

- 1 Removable Lifting Angle
- 2 Vented Areas — IP20 (NEMA Type 1) Only
- 3 Air Conditioner — IP54 (NEMA Type 12) Only
- 4 Heatsink (Fan Accessible from Inside of Enclosure)

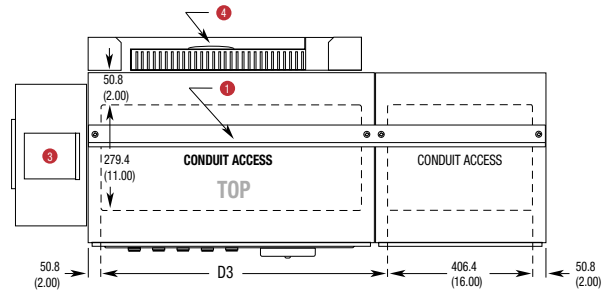
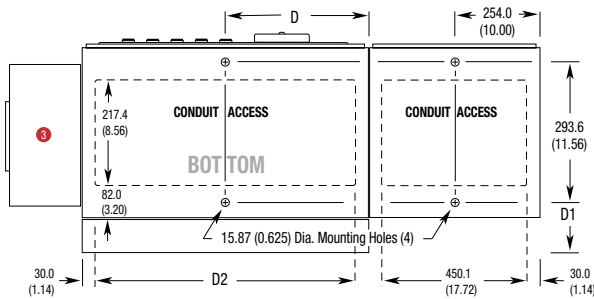

Approximate Shipping Weights
All Weights in Kilograms and (Pounds)

Frame	Three-Phase Ratings				All Dimensions in Millimeters and (Inches)									Drive/Option Enclosure Only		Drive/Option & Expanded Option Enclosures			
	230V	460V-CT	460V-VT	575V	A	A1	A2	A3	C	C1	C2	D	D1	D2	D3	IP20 (NEMA Type 1)	IP54 (NEMA Type 12)	IP20 (NEMA Type 1)	IP54 (NEMA Type 12)
D	30-45 kW	45-112 kW	56-112 kW	56-93 kW	635.0	1143.0	1378.0	1530.4	607.1	466.1	85.1	317.5	128.0	576.6	533.4	386	436	522	572
	40-60 HP (120-180 A)	60-150 HP (85-180 A)	75-150 HP (96-180 A)	75-125 HP (85-138 A)	(25.00)	(45.00)	(54.25)	(60.25)	(25.75)	(20.21)	(5.21)	(12.50)	(6.90)	(22.70)	(21.00)	(850)	(960)	(1150)	(1260)
E	56-93 kW	112-187 kW	149-187 kW	112-149 kW	889.0	1397.0	1632.0	1784.4	654.1	513.3	132.3	444.5	175.3	830.6	787.4	408	458	544	594
	75-125 HP (240-325 A)	150-250 HP (199-325 A)	200-250 HP (240-325 A)	150-300 HP (158-300 A)	(35.00)	(55.00)	(64.25)	(70.25)	(25.75)	(20.21)	(5.21)	(17.50)	(6.90)	(32.70)	(31.00)	(900)	(1010)	(1200)	(1310)

IP20 (NEMA Type 1) and IP54 (NEMA Type 12) Dimensions for F Frame Drives without Bypass

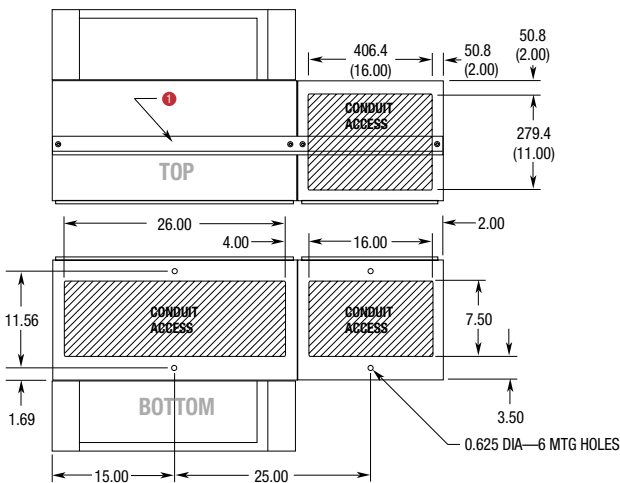
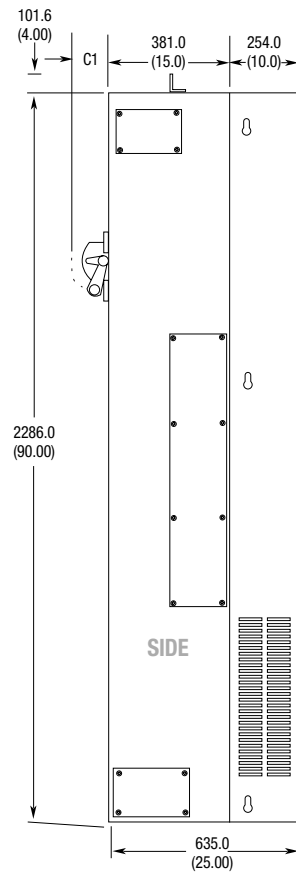
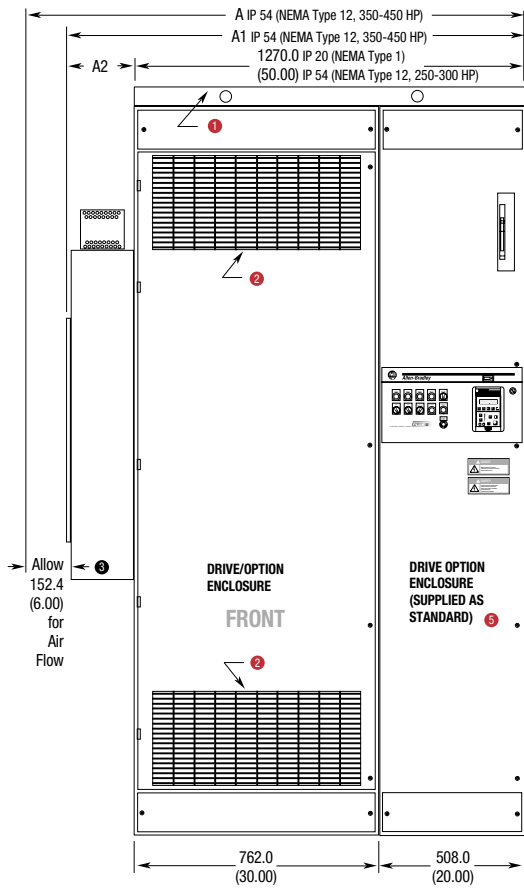

Option Mounting Location

Mountable CB, CF, CP, CT, DS, D1__, D2__, D3__, D5__, E__, D61,
Option List D91, GM_C, GD_C, GMS_C, HA__, HJ__, HN__, JC,
 JF, JM, JR, JT, K__, L__, L__, M__, M__, N3__, N__, UL

Consult Factory JL, JS, LQ, LT, LR, LW, MP12N, MP18A, MP12A, MP18N,
Option List MQ2, MQ3

- ① Removable Lifting Angle
- ② Vented Areas — IP20 (NEMA Type 1) Only
- ③ Air Conditioner — IP54 (NEMA Type 12) 350-450 HP Only
- ④ 350 HP Dimension is actually 139.7 (5.50)
- ⑤ **Special Smaller Enclosure**

A single 762 mm (30 in.) wide enclosure may be used if the option list requirements below are met. Consult factory for custom quotation in all cases.

Any combination of:

CM, D10-D91, EC, EP, ET, GD1C, GD2C, GM1C, GM2C, GM5C, JC, JF, JM, JR, JT, L4C, L5C, L4EC, L5EC, L6EC, LA_C, ME, all HIMs and a max. of (1) CF, EB, EH, N3, N4C, N4T, N5C, N5T or N9.

Approximate Shipping Weights
 All Weights in Kilograms and (Pounds)

Frame	Three-Phase Ratings			All Dimensions in Millimeters and (Inches)				Drive and Drive Option Enclosures	
	460V-CT	460V-VT	575V	A	A1	A2	C1	IP 20 (NEMA Type 1)	IP54 (NEMA Type 12)
F	187-224 kW 250-300 HP (325-360 A)	224 kW 300 HP (360 A)	—	NOT APPLICABLE – NO AIR CONDITIONER REQUIRED	—	—	139.7 (5.50)	624 (1375)	624 (1375)
	261-336 kW 350-450 HP (425-525 A)	261-336 kW 350-450 HP (425-525 A)	261-298 kW 350-400 HP (425-475 A)					1657.4 (65.25)	1422.4 (56.0)

Dimensions

IP20 (NEMA Type 1) and IP54 (NEMA Type 12) Dimensions for F Frame Drives with Bypass

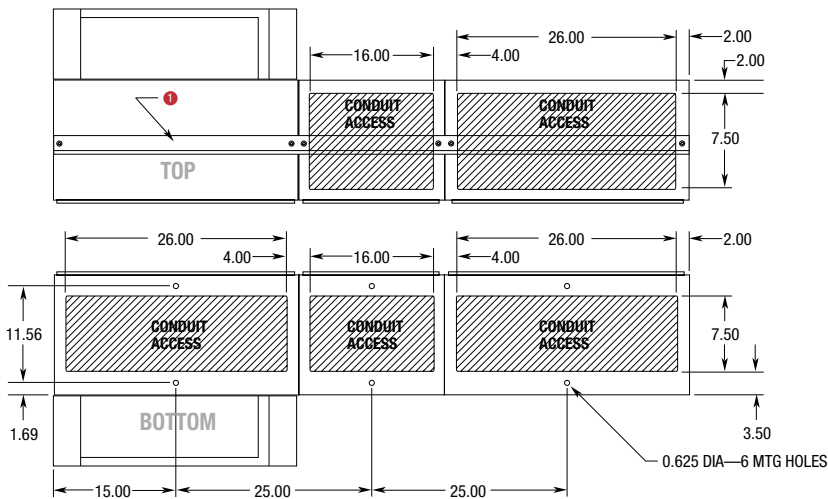
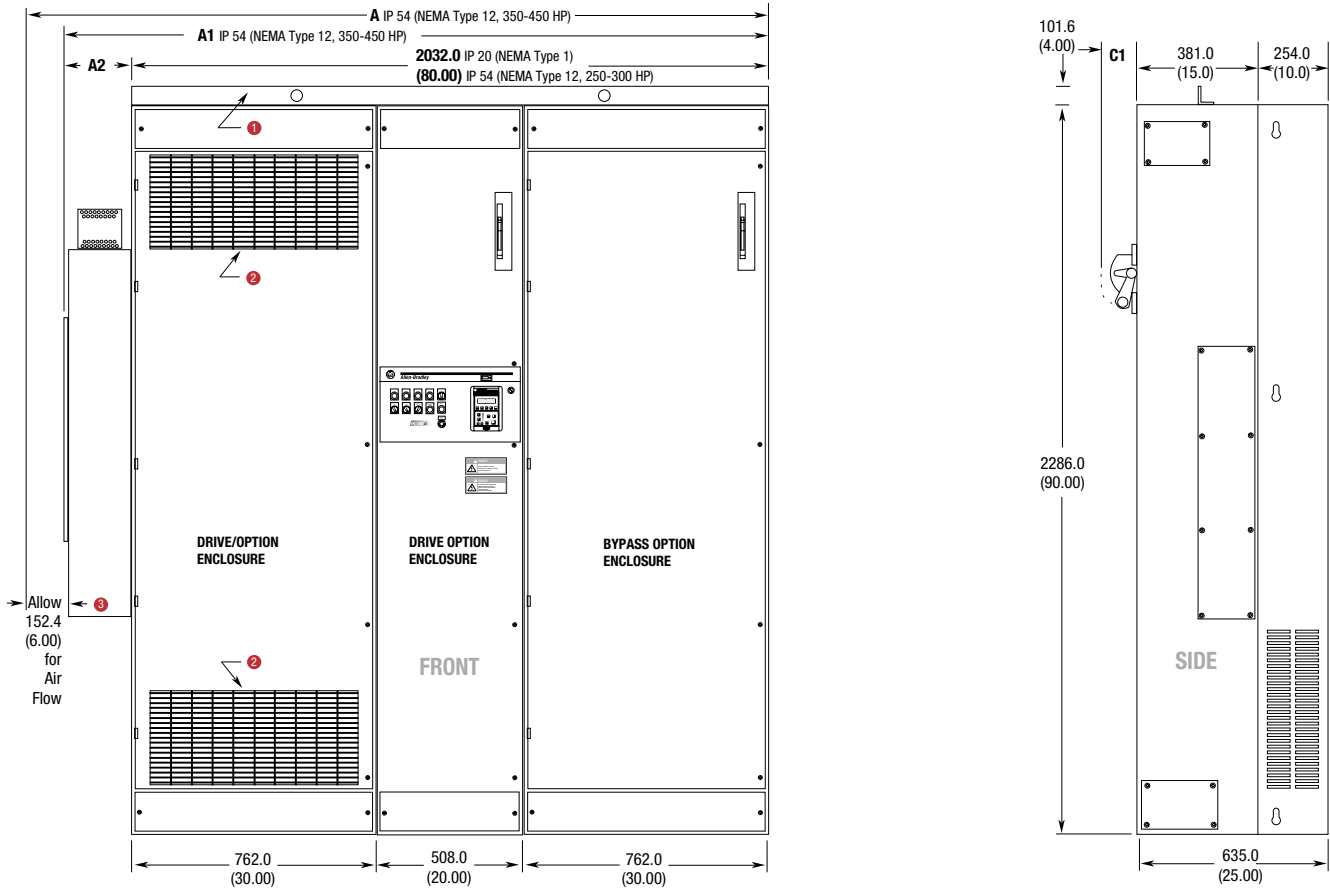

Option Mounting Location

Mountable Option List Option Codes From Previous Page Plus BA, BM, CC, D41, D42, DT, FM

Consult Factory Option List Option Codes From Previous Page Plus BC, BD, BP, BS, MP12A, MP12N, MP18A, MP18N, MQ2, MQ3

- ① Removable Lifting Angle
- ② Vented Areas — IP20 (NEMA Type 1) Only
- ③ Air Conditioner — IP54 (NEMA Type 12) 350-450 HP Only
- ④ 350 HP Dimension is actually 139.7 (5.50)

Approximate Shipping Weights
All Weights in Kilograms and (Pounds)

Frame	Three-Phase Ratings			All Dimensions in Millimeters and (Inches)				Drive, Drive Option and Bypass Option Enclosures	
	460V-CT	460V-VT	575V	A	A1	A2	C1	IP 20 (NEMA Type 1)	IP54 (NEMA Type 12)
F	187-224 kW 250-300 HP (325-360 A)	224 kW 300 HP (360 A)	—	—	NOT APPLICABLE – NO AIR CONDITIONER REQUIRED	—	139.7 (5.50)	1066 (2350)	1066 (2350)
	261-336 kW 350-450 HP (425-525 A)	261-336 kW 350-450 HP (425-525 A)	261-298 kW 350-400 HP (425-475 A)	2419.4 (95.25)	2267.0 (89.25)	235.0 (9.25)	215.9 ④ (8.50) ④	1066 (2350)	1247 (2750)

IP20 (NEMA Type 1) and IP54 (NEMA Type 12) Dimensions for G Frame Drives without Bypass

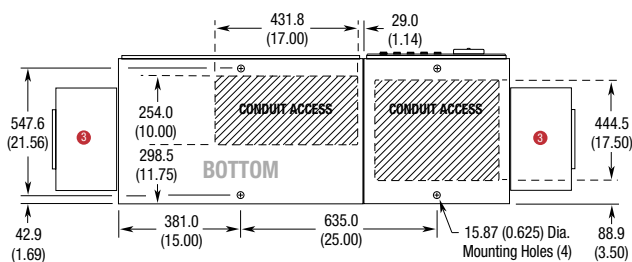
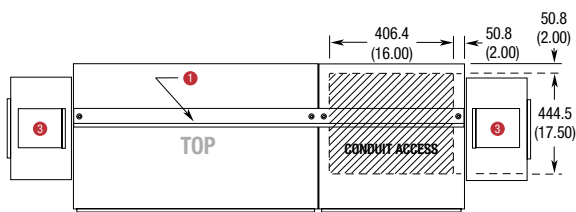
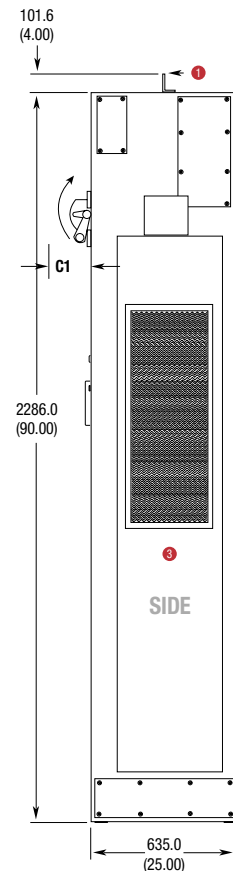
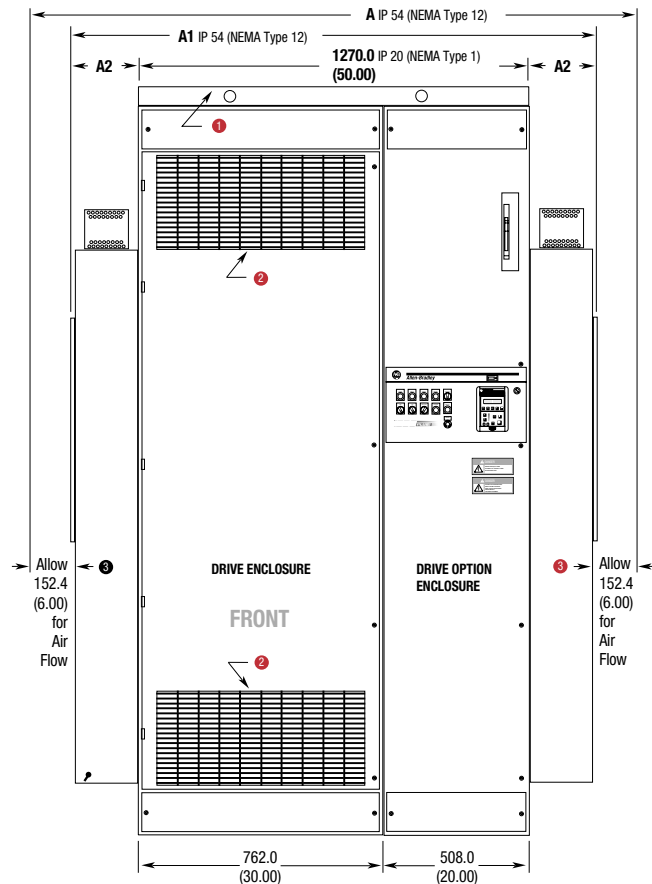

Option Mounting Location

Mountable CB, CF, CP, CT, DEC, DS, D1_, D2_, D3_, D5_, E_, D61, D91, GM_, GD_, GMS_, HA_, HJ_, HN_, ITC, JC, JF, JM, JR, JT, K_, L_, L_, M_, M_, N3, N_, UL

Consult Factory JA, JL, JS, LQ, LT, LR, LW, MP12A, MP12N, MP18A, MP18N, MQ2, MQ3

Special Smaller Enclosure

A single 762 mm (30 in.) wide enclosure may be used if the option list requirements below are met. Consult factory for custom quotation in all cases.

Any combination of:

CM, D10-D91, EC, EP, ET, GD1C, GD2C, GM1C, GM2C, GM5C, JC, JF, JM, JR, JT, L4C, L5C, L4EC, L5EC, L6EC, LA_C, all HIMs and a max. of (1) CF, EB, EH, N2, N3, N4C, N4T, N5C, N5T or N9.

- ① Removable Lifting Angle
- ② Vented Areas — IP20 (NEMA Type 1) Only
- ③ Air Conditioner — IP54 (NEMA Type 12) Only

Approximate Shipping Weights
All Weights in Kilograms and (Pounds)

Frame	Three-Phase Ratings			All Dimensions in Millimeters and (Inches)				Drive and Drive Option Enclosures	
	460V-CT	460V-VT	575V	A	A1	A2	C1	IP 20 (NEMA Type 1)	IP54 (NEMA Type 12)
G	224-261 kW 300-350 HP (360-425 A)	224-261 kW 300-350 HP (360-425 A)	224-261 kW 300-350 HP (360-425 A)	2103.1 (82.80)	1798.3 (70.80)	264.2 (10.40)	139.7 (5.50)	624 (1375)	805 (1775)
	298-448 kW 400-600 HP (475-670 A)	298-448 kW 400-600 HP (475-670 A)	298-448 kW 400-600 HP (400-600 A)	2230.1 (87.80)	1925.3 (75.8)	327.7 (12.9)	215.9 (8.50)	624 (1375)	832 (1885)

Dimensions

IP20 (NEMA Type 1) and IP54 (NEMA Type 12) Dimensions for G Frame Drives with Bypass

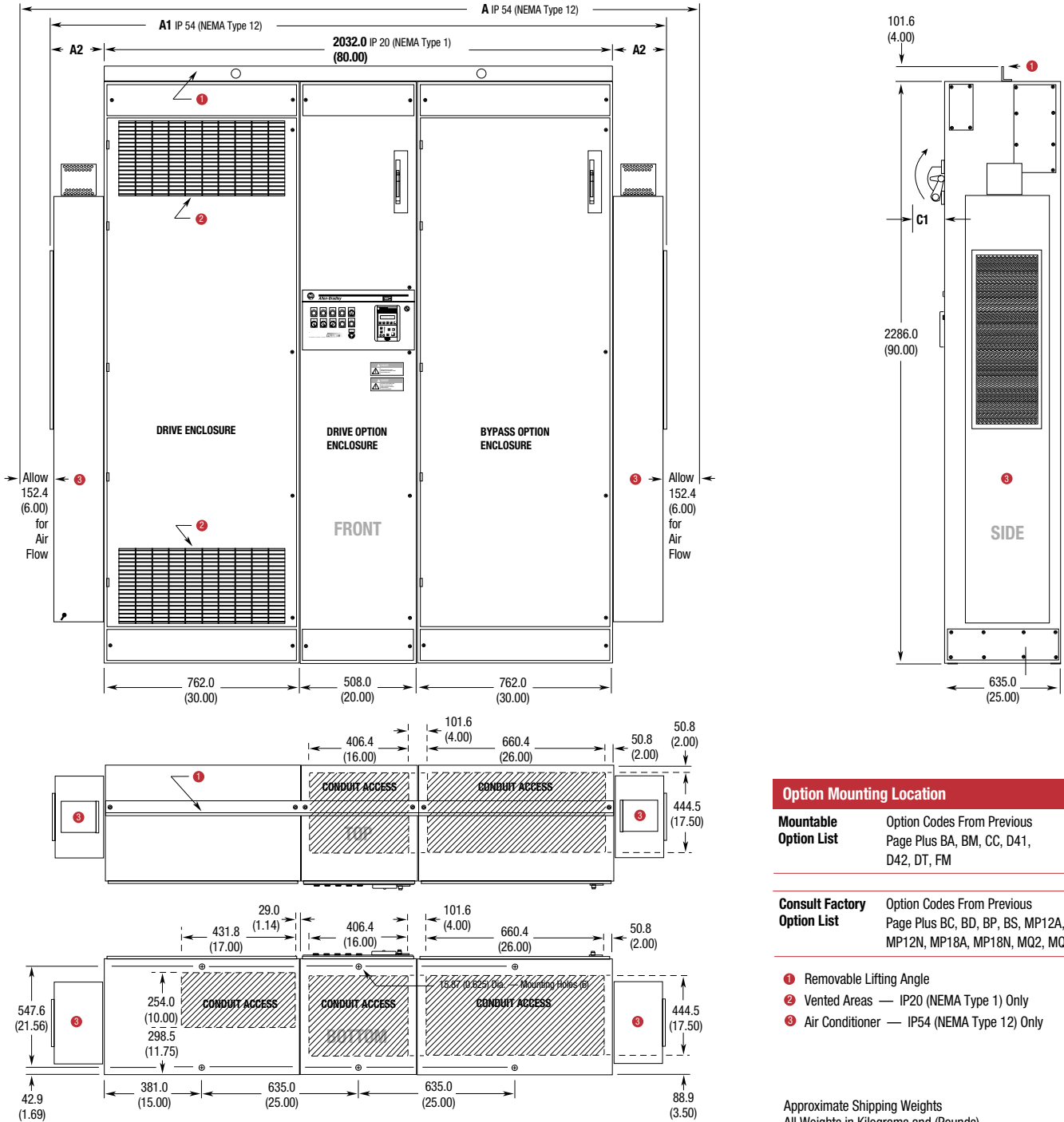

Option Mounting Location

Mountable Option List Option Codes From Previous Page Plus BA, BM, CC, D41, D42, DT, FM

Consult Factory Option List Option Codes From Previous Page Plus BC, BD, BP, BS, MP12A, MP12N, MP18A, MP18N, MQ2, MQ3

- 1 Removable Lifting Angle
- 2 Vented Areas — IP20 (NEMA Type 1) Only
- 3 Air Conditioner — IP54 (NEMA Type 12) Only

Approximate Shipping Weights
All Weights in Kilograms and (Pounds)

Three-Phase Ratings			All Dimensions in Millimeters and (Inches)					Drive, Drive Option and Bypass Option Enclosures	
Frame	460V-CT	460V-VT	575V	A	A1	A2	C1	IP 20 (NEMA Type 1)	IP54 (NEMA Type 12)
G	224-261 kW 300-350 HP (360-425 A)	224-261 kW 300-350 HP (360-425 A)	224-261 kW 300-350 HP (360-425 A)	2865.1 (112.80)	2560.3 (100.80)	264.2 (10.40)	139.7 (5.50)	1066 (2350)	1247 (2750)
	298-448 kW 400-600 HP (475-670 A)	298-448 kW 400-600 HP (475-670 A)	298-448 kW 400-600 HP (400-600 A)	2992.1 (117.80)	2687.3 (105.80)	327.7 (12.90)	215.9 (8.50)	1066 (2350)	1275 (2810)

The panel layouts shown on the following pages are typical for the drive ratings listed. The layouts include a worst case **Pre-Engineered (P) Options Only** scenario (See Option List on the next page). The dimension grid can be used to determine available panel space by taking into account which of the components shown will actually be included in an individual drive package.

A1-A3 Frame Drives – 230/460V 0.37-3.7 kW (0.5-5 HP)

IP20 (NEMA Type 1)

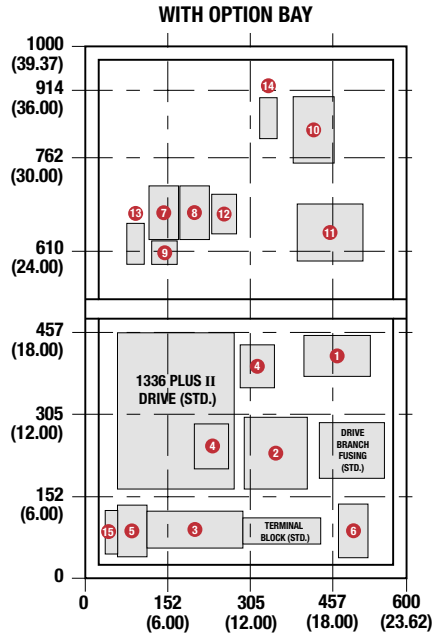

All dimensions in millimeters and (inches)

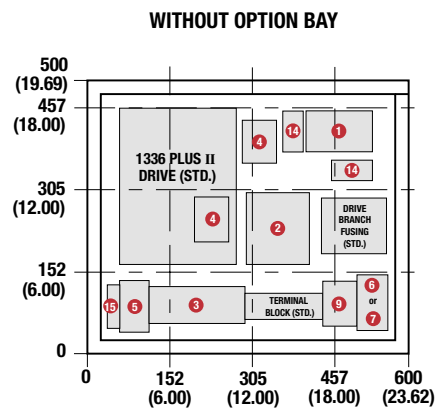

IP54 (NEMA Type 12) – IP65 (NEMA Type 4)

Consult Allen-Bradley when adding additional heat producing components to existing NEMA Type 4 or 12 rated drives.

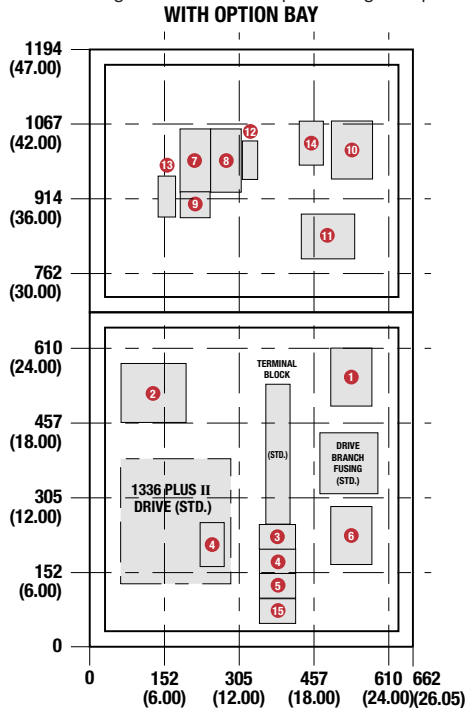

All dimensions in millimeters and (inches)

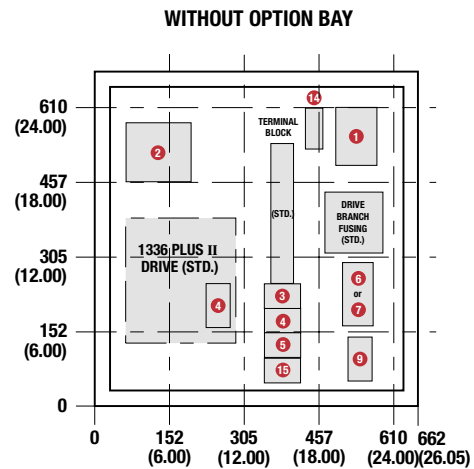

- | | | |
|--|--|---------------------------|
| 1 DRIVE CIRCUIT BREAKER OR DISCONNECT SWITCH | 6 DRIVE INPUT CONTACTOR | 11 BYPASS MOTOR FUSES |
| 2 CONTROL TRANSFORMER | 7 DRIVE OUTPUT CONTACTOR | 12 AUTO BYPASS LOGIC |
| 3 RELAY LOGIC (VARIES) | 8 BYPASS CONTACTOR | 13 MOTOR GROUND TERMINAL |
| 4 COMMUNICATION OPTION CARD (DRIVE OR PANEL MOUNTED) | 9 OVERLOAD RELAY | 14 LINE GROUND TERMINAL |
| 5 INPUT ISOLATOR | 10 BYPASS CIRCUIT BREAKER OR DISCONNECT SWITCH | 15 SIGNAL GROUND TERMINAL |

Panel Layouts

Pre-engineered (P) options include the following catalog numbers

-AA	-D10	-D31	-GM5C	-HNSBC	-LA2C
-AF	-D11	-D32	-GM6C	-HNSPC	-LA3C
-AJ	-D12	-D41	-GMS1C	-HNS1C	-LA4C
-BA	-D13	-D42	-GMS2C	-HNS2C	-LA5C
-BM	-D14	-D51	-GMS5C	-JC	-LA6C
-CB	-D15	-D52	-GMS6C	-JF	-LA7C
-CC	-D16	-D61	-HABC	-JM	-L9EC
-CF	-D17	-FM	-HAPC	-JR	-ME
-CP	-D18	-GD1C	-HA1C	-JT	-MK
-CT	-D19	-GD2C	-HA2C	-KD	-MT
-DS	-D21	-GM1C	-HJPC	-KM	-N3
-DT	-D22	-GM2C	-HJ2C	-LA1C	

A4 Frame Drives – 460V 5.5-15 kW (7.5-20 HP)

IP20 (NEMA Type 1)

WITH OPTION BAY

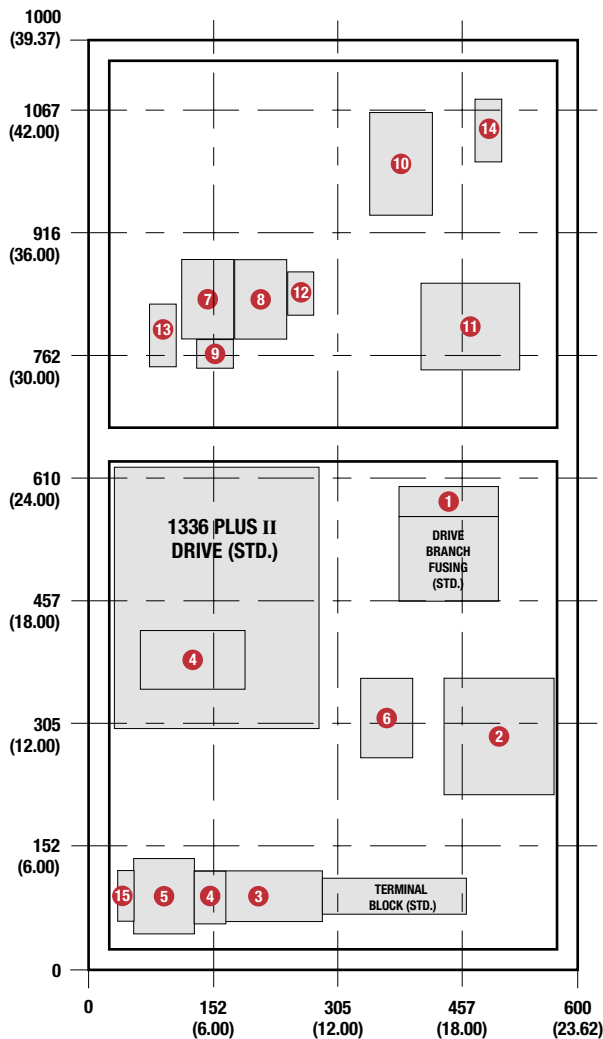

All dimensions in millimeters and (inches)

WITHOUT OPTION BAY

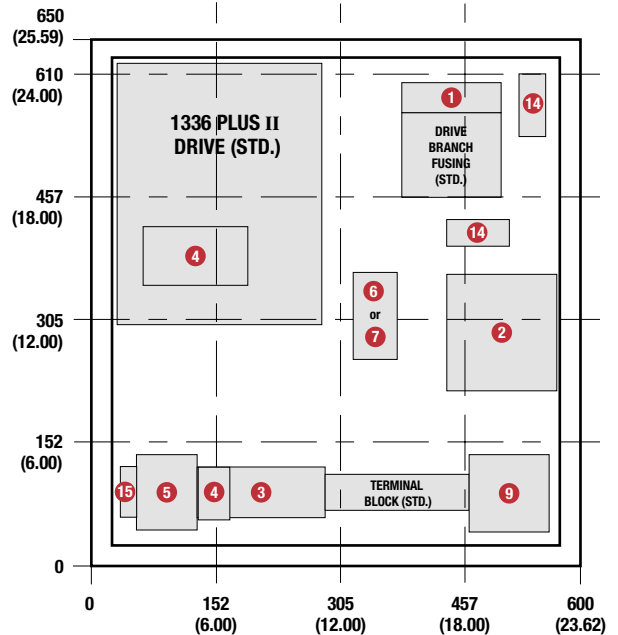

- ① DRIVE CIRCUIT BREAKER OR DISCONNECT SWITCH
- ② CONTROL TRANSFORMER
- ③ RELAY LOGIC (VARIES)
- ④ COMMUNICATION OPTION CARD (DRIVE OR PANEL MOUNTED)

- ⑤ INPUT ISOLATOR
- ⑥ DRIVE INPUT CONTACTOR
- ⑦ DRIVE OUTPUT CONTACTOR
- ⑧ BYPASS CONTACTOR
- ⑨ - ⑮ NEXT PAGE

B1-B2 Frame Drives – 230V 5.5-11 kW (7.5-15 HP) – 460V 11-22 kW (15-30 HP)

IP20 (NEMA Type 1)



A4, B1 And B2 Frame Drives – 230V 5.5-11 kW (7.5-15 HP) – 460V 5.5-22 kW (7.5-30 HP) – 575V .75-15 kW (1-20 HP)

IP54 (NEMA Type 12) – IP65 (NEMA Type 4)

Consult Allen-Bradley when adding additional heat producing components to existing NEMA Type 12 rated drives.

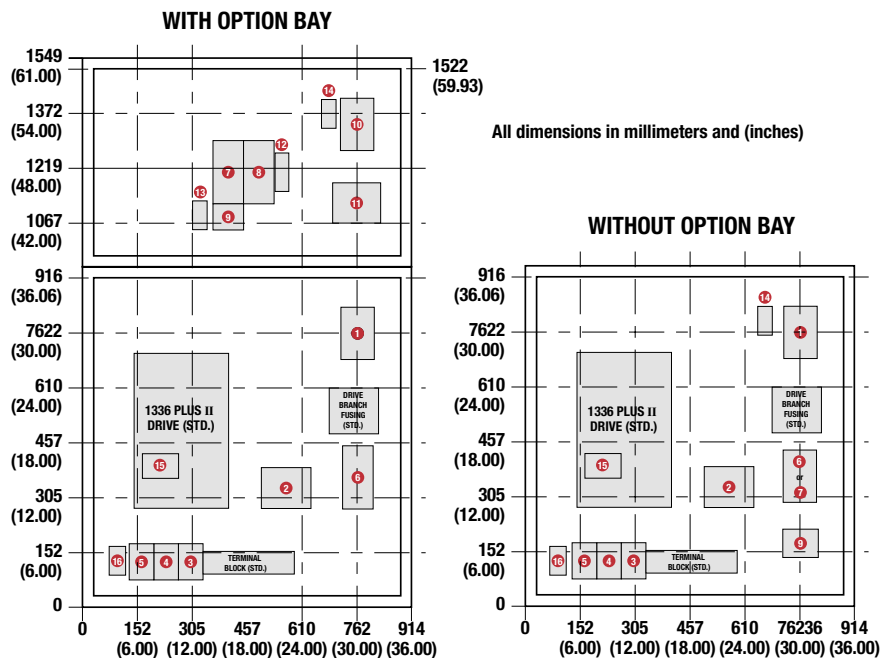

- | | |
|--|---------------------------|
| 1 - 8 PREVIOUS PAGE | 12 AUTO BYPASS LOGIC |
| 9 OVERLOAD RELAY | 13 MOTOR GROUND TERMINAL |
| 10 BYPASS CIRCUIT BREAKER OR DISCONNECT SWITCH | 14 LINE GROUND TERMINAL |
| 11 BYPASS MOTOR FUSES | 15 SIGNAL GROUND TERMINAL |

Panel Layouts

C Frame Drives – 230V 15-22 kW (20-30 HP) – 460V 30-45 kW (40-60 HP) – 575V 18.5-45 kW (25-60 HP)

IP20 (NEMA Type 1)

WITH OPTION BAY

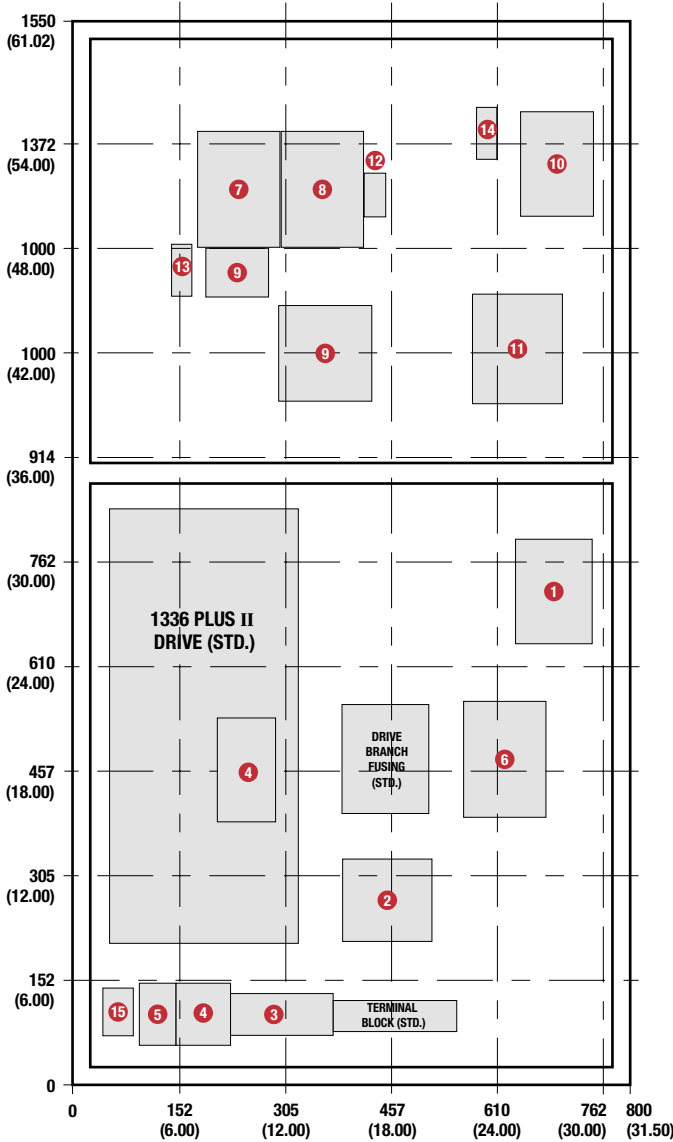

All dimensions in millimeters and (inches)

WITHOUT OPTION BAY

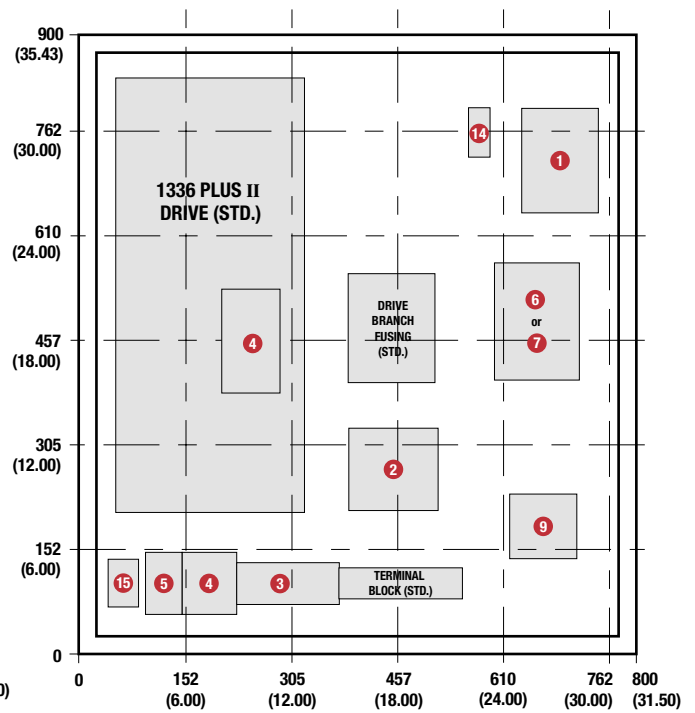

- ① DRIVE CIRCUIT BREAKER OR DISCONNECT SWITCH
- ② CONTROL TRANSFORMER
- ③ RELAY LOGIC (VARIES)
- ④ COMMUNICATION OPTION CARD (DRIVE OR PANEL MOUNTED)

- ⑤ INPUT ISOLATOR
- ⑥ DRIVE INPUT CONTACTOR
- ⑦ DRIVE OUTPUT CONTACTOR
- ⑧ BYPASS CONTACTOR
- ⑨ - ⑮ NEXT PAGE

C Frame Drives – 230V 15-22 kW (20-30 HP) – 460V 30-45 kW (40-60 HP) – 575V 18.5-45 kW (25-60 HP)

IP54 (NEMA Type 12) – IP65 (NEMA Type 4)

Consult Allen-Bradley when adding additional heat producing components to existing NEMA Type 4 or 12 rated drives.

WITH OPTION BAY

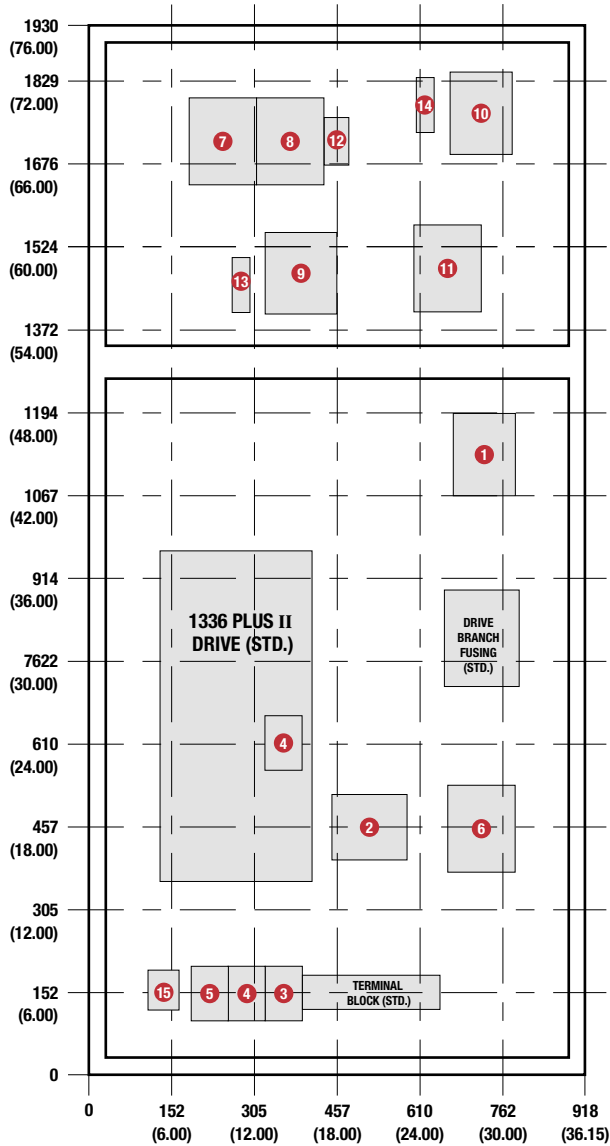

All dimensions in millimeters and (inches)

WITHOUT OPTION BAY

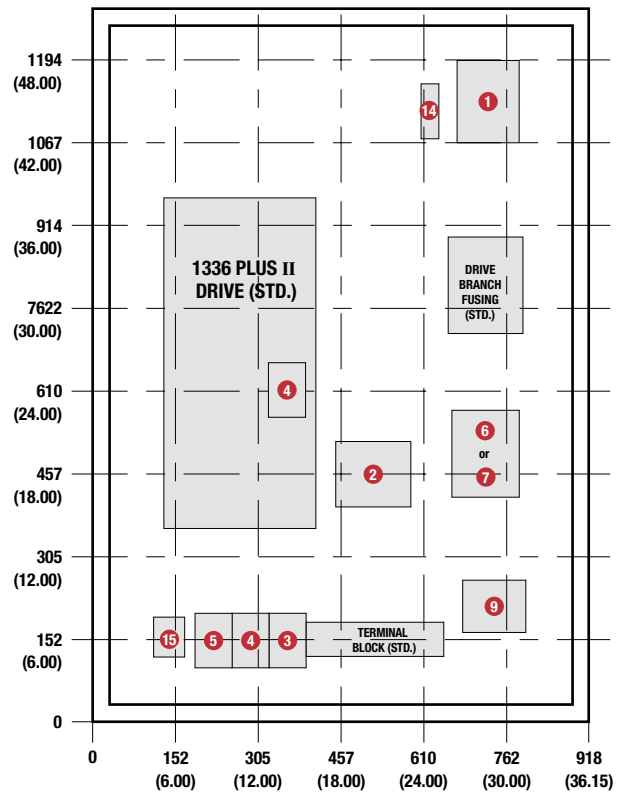

- 1 - 8 PREVIOUS PAGE
- 9 OVERLOAD RELAY
- 10 BYPASS CIRCUIT BREAKER OR DISCONNECT SWITCH
- 11 BYPASS MOTOR FUSES

- 12 AUTO BYPASS LOGIC
- 13 MOTOR GROUND TERMINAL
- 14 LINE GROUND TERMINAL
- 15 SIGNAL GROUND TERMINAL

Panel Layouts

D Frame Drives – 230V 30-45 kW (40-60 HP) – 460V 45-112 kW (60-150 HP @ 180A) – 575V 56-93 kW (75-125 HP)

IP20 or IP54 (NEMA Type 1 or NEMA Type 12)

Consult Allen-Bradley when adding additional heat producing components to existing NEMA Type 12 rated drives.

WITH OPTION BAY

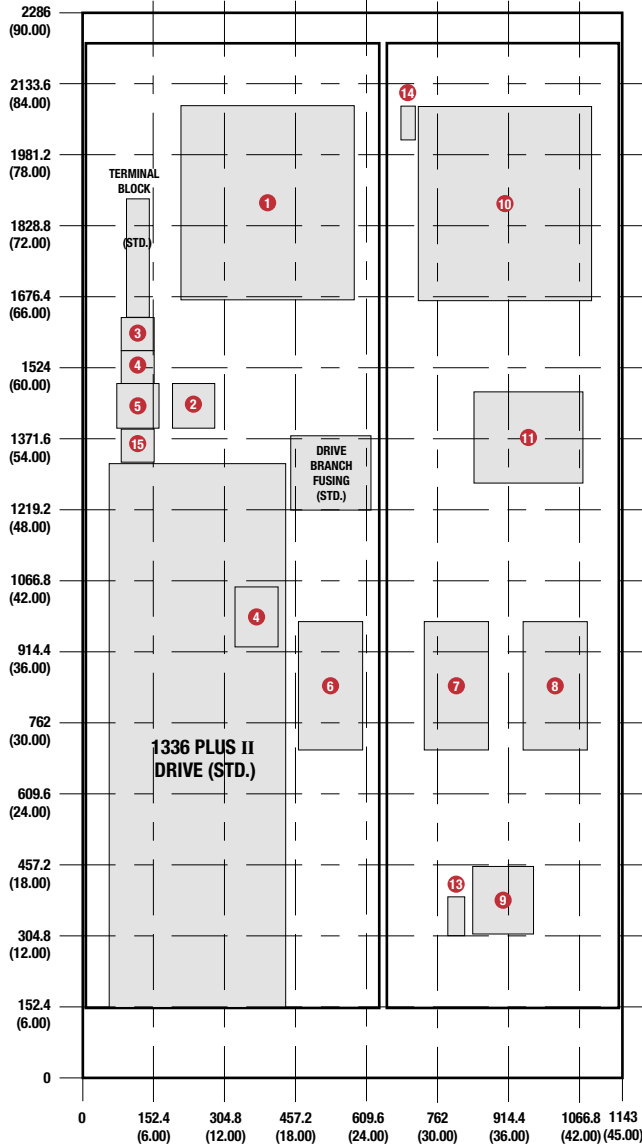

WITHOUT OPTION BAY

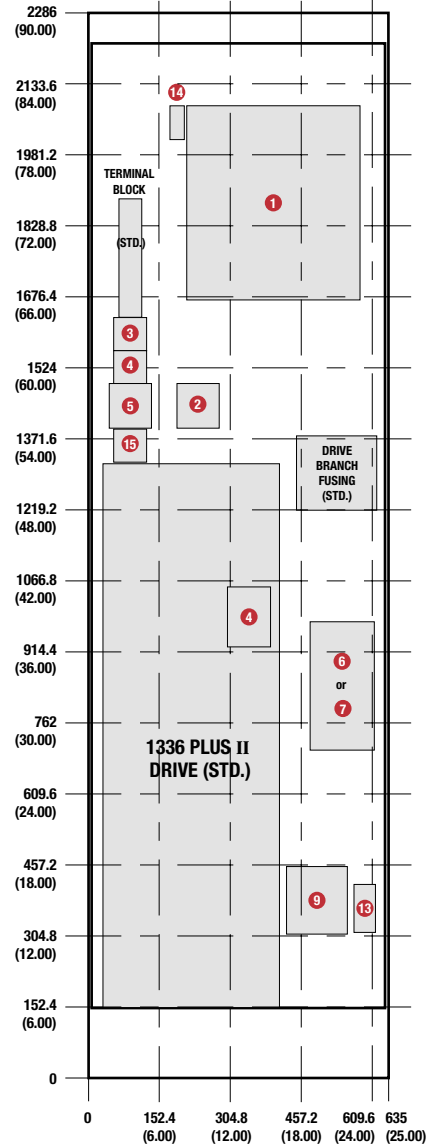

All dimensions in millimeters and (inches)

- | | |
|--|--------------------------|
| ① DRIVE CIRCUIT BREAKER OR DISCONNECT SWITCH | ⑤ INPUT ISOLATOR |
| ② CONTROL TRANSFORMER | ⑥ DRIVE INPUT CONTACTOR |
| ③ RELAY LOGIC (VARIES) | ⑦ DRIVE OUTPUT CONTACTOR |
| ④ COMMUNICATION OPTION CARD (DRIVE OR PANEL MOUNTED) | ⑧ BYPASS CONTACTOR |
| | ⑨ - ⑮ NEXT PAGE |

E Frame Drives – 230V 56-93 kW (75-125 HP) – 460V 112-187 kW (150 @ 199A-250 HP) – 575V 112-224 kW (150-300 HP)

IP20 or IP54 (NEMA Type 1 or NEMA Type 12)

Consult Allen-Bradley when adding additional heat producing components to existing NEMA Type 12 rated drives.

WITH OPTION BAY

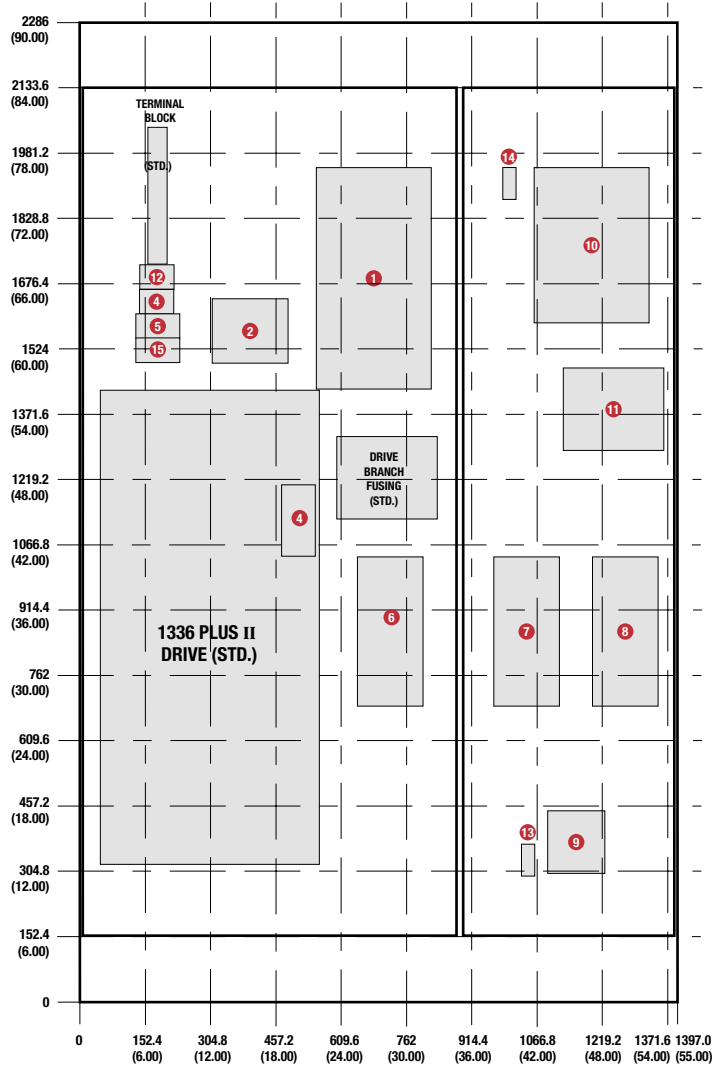

WITHOUT OPTION BAY

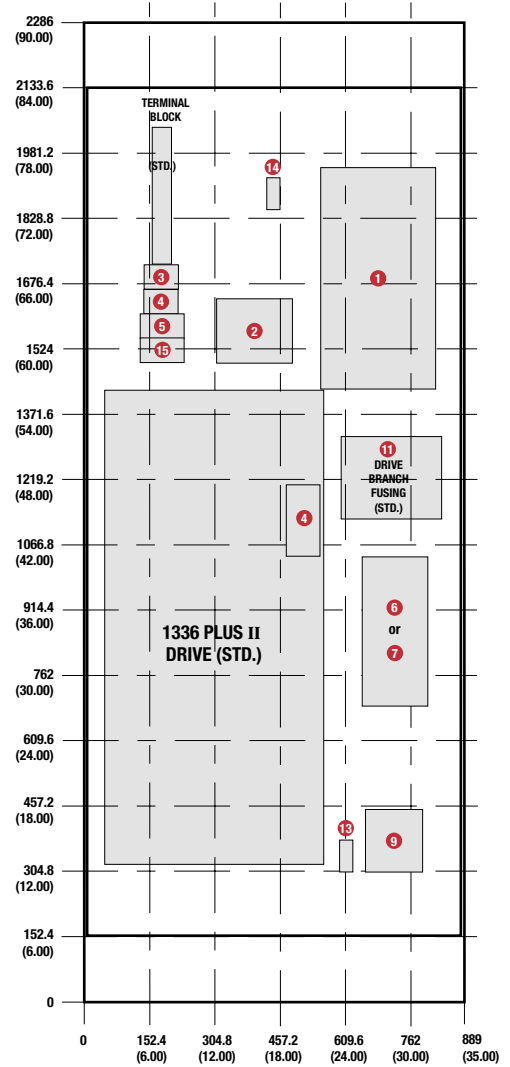

All dimensions in millimeters and (inches)

- | | |
|---|----------------------------------|
| 1 - 8 PREVIOUS PAGE | 12 AUTO BYPASS LOGIC |
| 9 OVERLOAD RELAY | 13 MOTOR GROUND TERMINAL |
| 10 BYPASS CIRCUIT BREAKER OR DISCONNECT SWITCH | 14 LINE GROUND TERMINAL |
| 11 BYPASS MOTOR FUSES | 15 SIGNAL GROUND TERMINAL |

Panel Layouts

F Frame Drives– 460V 187-336 kW (250-450 HP) – 575V 261-298 kW (350-400 HP)

IP20 or IP54 (NEMA Type 1 or NEMA Type 12)

Consult Allen-Bradley when adding additional heat producing components to existing IP 54 (NEMA Type 12) rated drives.

F FRAME 2-BAY WITHOUT BYPASS

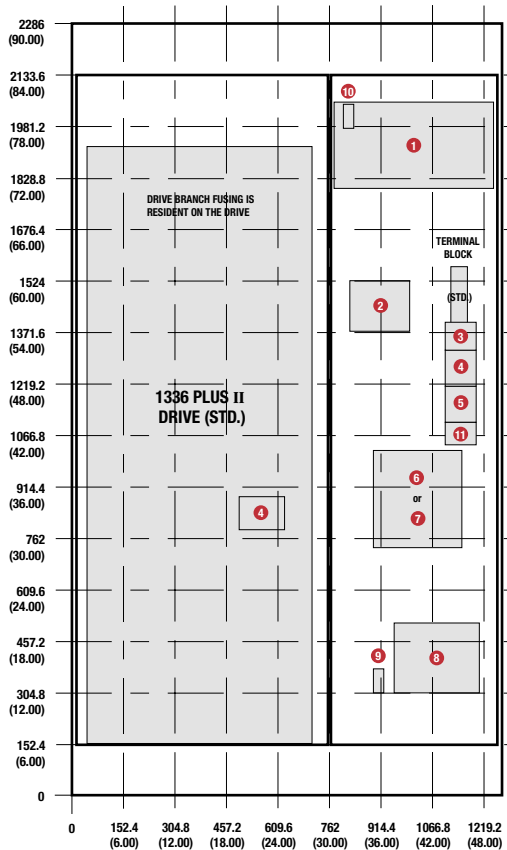

F FRAME 3-BAY WITH BYPASS

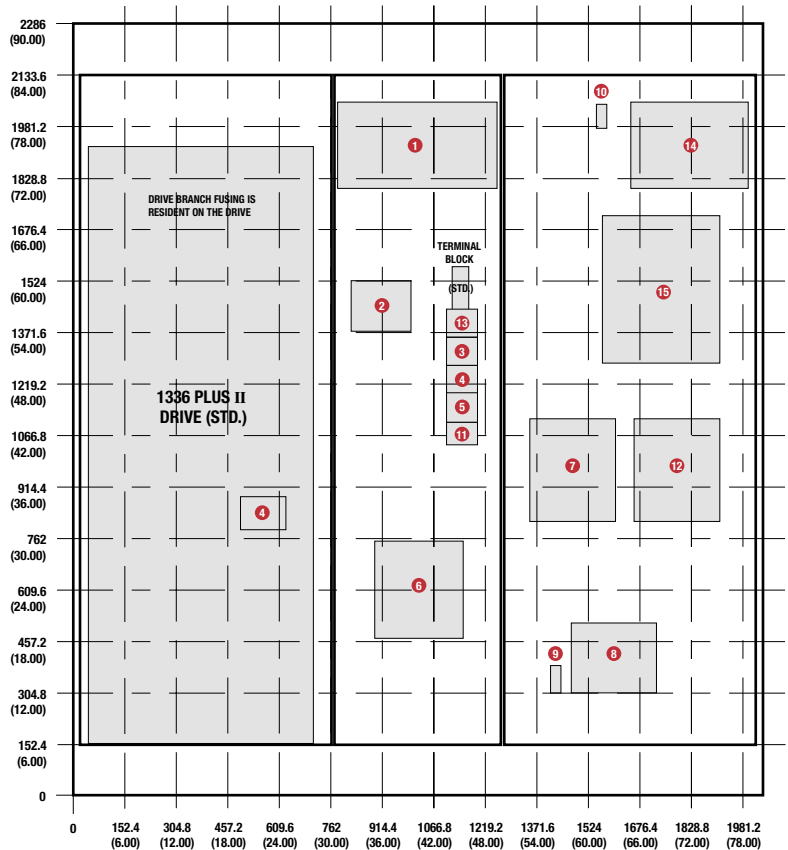

All dimensions in millimeters and (inches)

- 1 DRIVE CIRCUIT BREAKER OR DISCONNECT SWITCH
- 2 CONTROL TRANSFORMER
- 3 RELAY LOGIC (VARIES)
- 4 COMMUNICATION OPTION CARD (DRIVE OR PANEL MOUNTED)

- 5 INPUT ISOLATOR
- 6 DRIVE INPUT CONTACTOR
- 7 DRIVE OUTPUT CONTACTOR
- 8 OVERLOAD RELAY

G Frame Drives – 460V 224-448 kW (300-600 HP) – 575V 224-448 kW (300-600 HP)

IP20 or IP54 (NEMA Type 1 or NEMA Type 12)

Consult Allen-Bradley when adding additional heat producing components to existing NEMA Type 12 rated drives.

2-BAY WITHOUT BYPASS

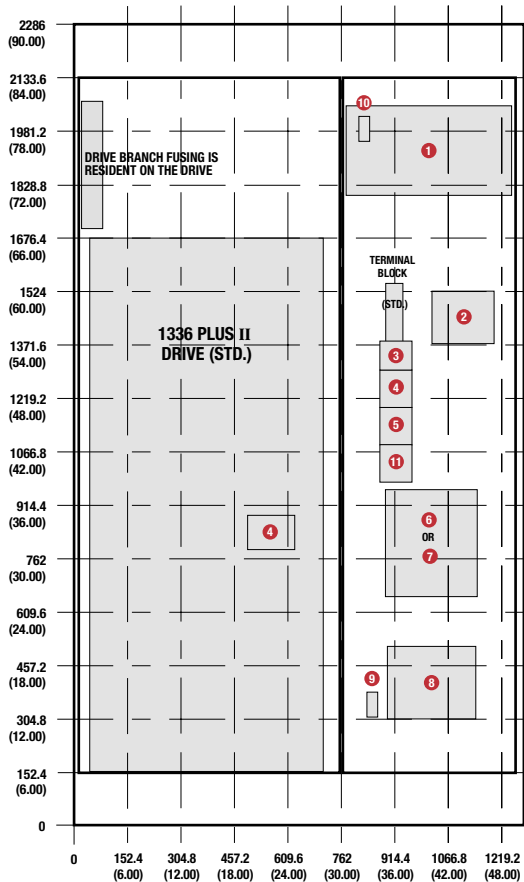

3-BAY WITH BYPASS

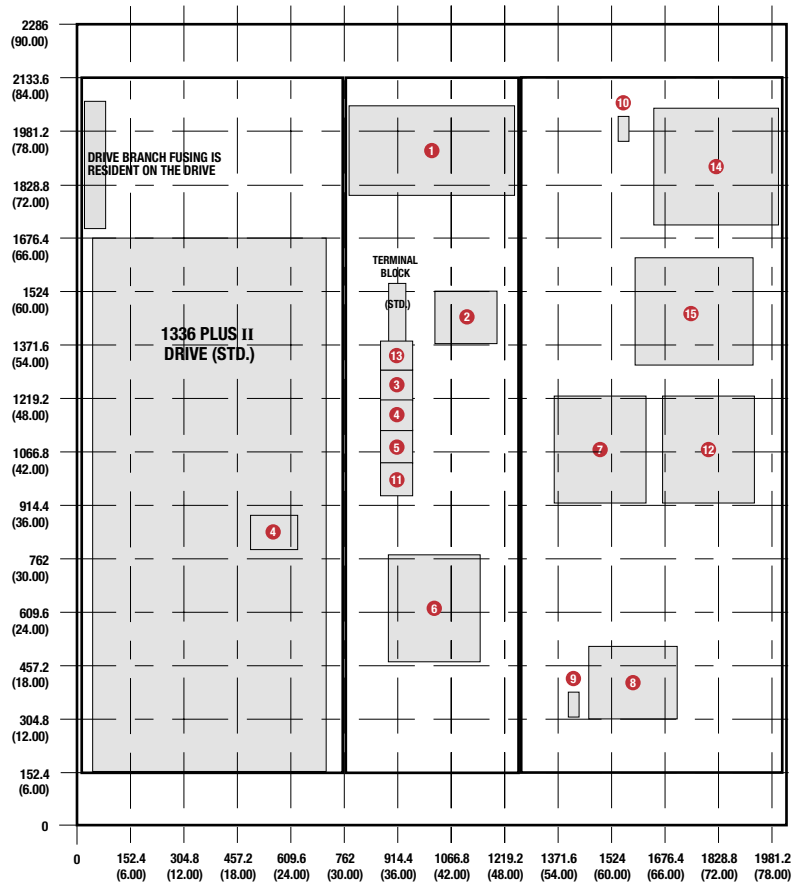

All dimensions in millimeters and (inches)

1 - 8 PREVIOUS PAGE

9 MOTOR PE

10 LINE GROUND TERMINAL

11 SIGNAL GROUND TERMINAL

12 BYPASS CONTACTOR

13 AUTO BYPASS LOGIC

14 BYPASS CIRCUIT BREAKER OR DISCONNECT SWITCH

15 BYPASS MOTOR FUSES

Wire Terminations

Power Wiring – Drive Terminal Block TB1

The TB1 Terminal Block connections shown below are a generic representation intended to show the interface of internal or remote power devices to the power terminal block. Specific TB1 terminal locations may vary by standard drive rating. For more information refer to the Standard Drives section.

The location of user cable connections to a packaged drive will vary with the particular power options chosen. After an order is entered, Approval Drawings or Manufacturing Drawings may be ordered prior to shipment, and specific customer interconnection information is supplied.

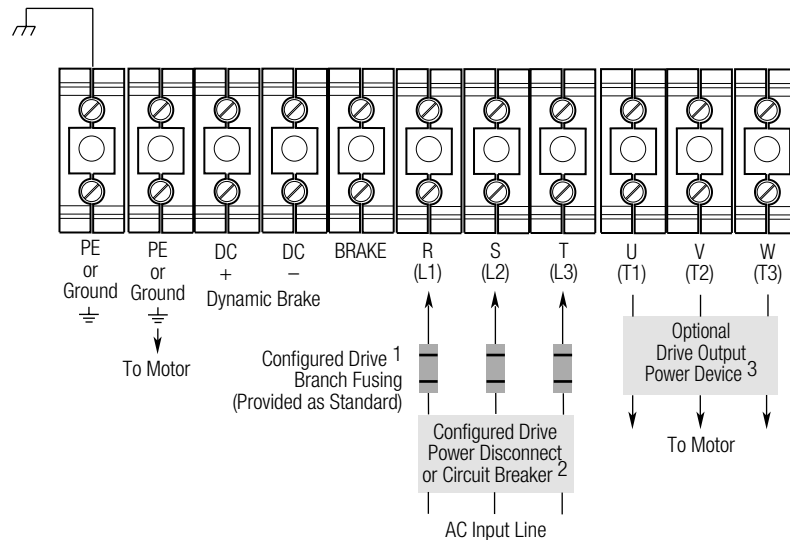

User-supplied remote power disconnect



ATTENTION: Any user-supplied disconnecting means wired to drive output terminals U, V and W must be capable of disabling the drive if opened during drive operation. If opened during drive operation, the drive will continue to produce output voltage between U, V and W. An auxiliary contact must be used to simultaneously disable the drive or output component damage may occur.

User-supplied remote drive bypass system



ATTENTION: An incorrectly customer applied or installed bypass system can result in component damage or reduction in product life. The most common causes are:

- Wiring AC line to drive output or control terminals.
- Improper bypass or output circuits.
- Output circuits which do not connect directly to the motor.

Contact Allen-Bradley for assistance with application or wiring.

¹ Packaged drives may have different input fuse ratings than those recommended for equivalent standard 1336 PLUS II drives. Packaged drives are rated for a single input voltage (not a voltage range) and may have fuses resident on the drive (F Frame) or an optional disconnect switch.

² If a drive input power option is not supplied, incoming power connections are made directly to the drive branch fusing (except F or G Frame drives or any drive with bypass).

³ If a drive output power option is not supplied, motor connections are made directly to drive terminals U, V and W.

Control and Signal Wiring – Drive Terminal Block TB2

The TB2 Terminal Block connections shown below are a generic representation intended to show the interface of internal or remote signal and control devices to the terminal block. This terminal block is located on the bottom of the main control board. Specific TB2 terminal locations may vary by standard drive rating. For more information refer to the Standard Drives section.

The location of user control wire connections to a packaged drive will vary with the particular control options chosen. After an order is entered, Approval Drawings or Manufacturing Drawings may be ordered prior to shipment, and specific customer interconnection information is supplied.

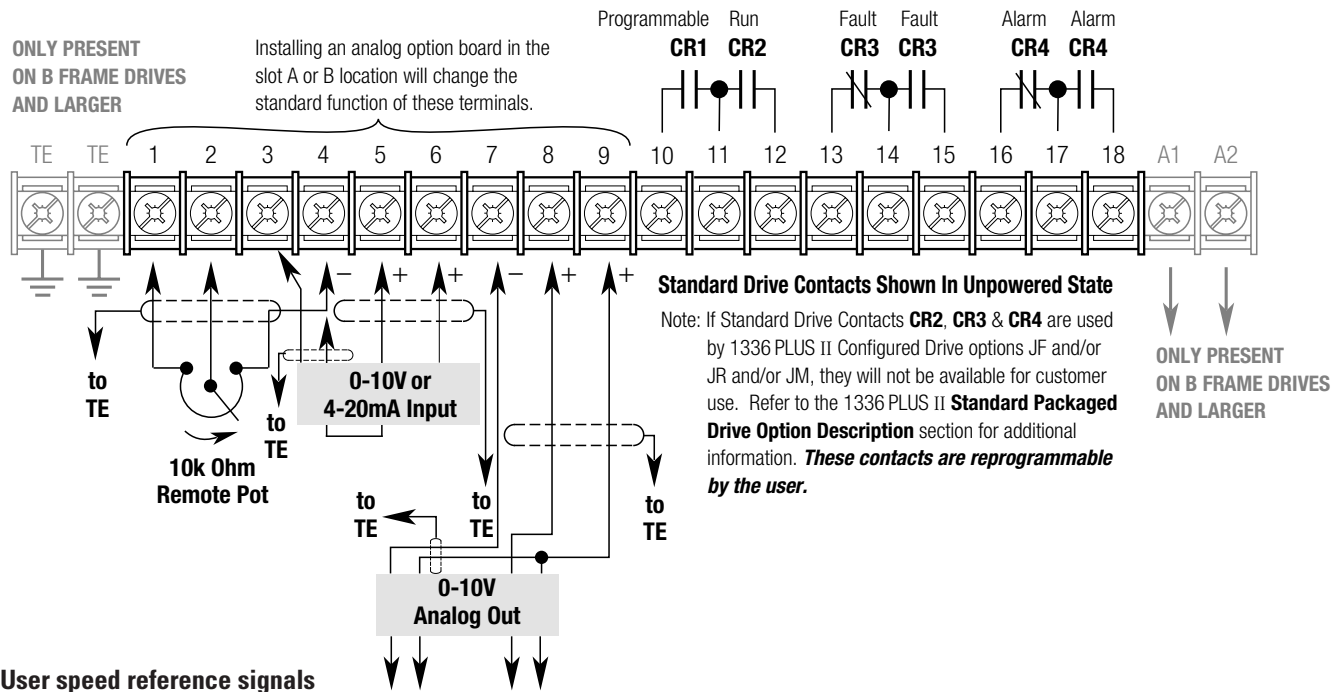

ATTENTION: Signal Common – User reference signals are terminated to logic common at TB2, terminal 3, 4 or 5. This puts the negative (or common) side of these signals at earth ground potential. Control schemes must be examined for possible conflicts with this type of grounding scheme.

Wire Terminations

Control Interface Wiring – Drive Terminal Block TB3

Control interface inputs are connected to terminal Block TB3. TB3 is located on the Control Interface Board installed in the drive. All 1336 PLUS II Packaged Drives come with a 115V AC Control Interface Card (Option L6) unless otherwise specified. 24V AC/DC control and Contact Closure control are available as options. Encoder feedback is available as an option with any of the three control methods.

All control interface cards provide input terminals for access to fixed drive functions that include start, stop, and enable. Four additional inputs are programmed for functions such as reverse, preset speed access, jog, second accel/decel time access and local control selection. The function of each input is defined through programming. For Packaged Drives, functions are pre-programmed at the factory for a specific application and configuration and should not require field re-programming.

A variety of combinations made up of the following inputs are available.

- Start
- Stop/Clear Fault
- Reverse
- Digital Potentiometer (MOP)
- 2 Accel/Decel Rates
- 3 Speed Selects
- Enable
- Auxiliary
- 2 Stop Mode Selects
- Run Forward
- Run Reverse
- Local Control

	Control Interface Options		
	115V AC	24V AC/DC	TTL Contact
Without Encoder Feedback	Std.	-L5C	-L4C
With Encoder Feedback	-L9EC	-L8EC	-L7EC



ATTENTION: The drive is intended to be controlled by control input signals that will start and stop the motor. A device that routinely disconnects then reapplies line power to the drive for the purpose of starting and stopping the motor **is not** recommended. If this type of circuit is used, a maximum of 3 stops in any 5-minute period with a minimum 1-minute rest between each cycle is required. These 5-minute periods must be separated by 10-minute rest cycles to allow the drive precharge resistors to cool. Refer to codes and standards applicable to your particular system for specific requirements and additional information.



ATTENTION: User remote speed reference signals are terminated to logic common at TB2 terminals 3 & 4. This puts the negative or common side of these signals at earth ground potential. Control schemes should be examined for possible conflict with this grounding scheme and possible equipment damage.

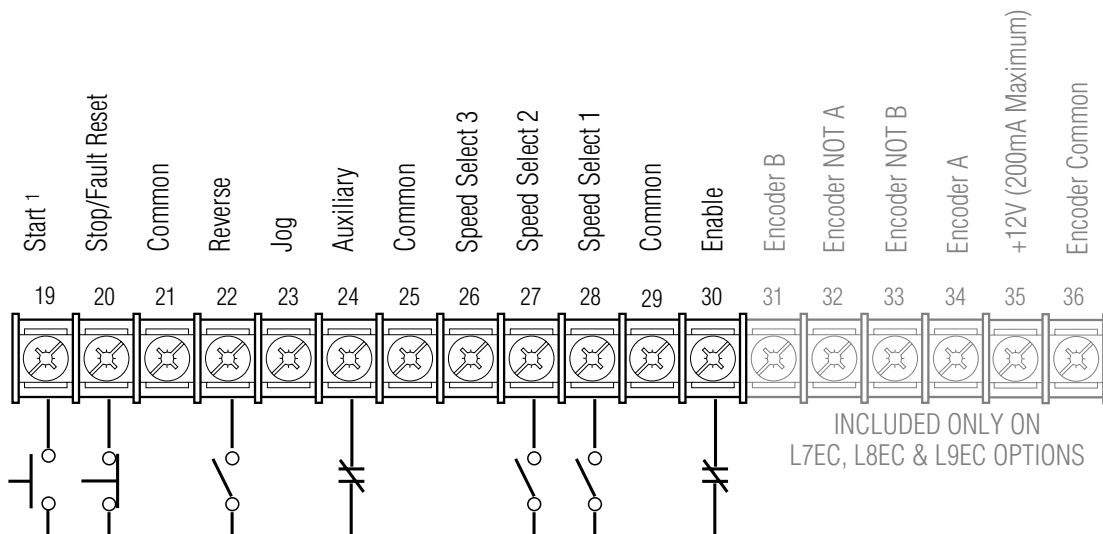

The maximum and minimum wire size accepted by TB3 is 2.1 and 0.30 mm² (14 and 22 AWG). Maximum torque for all terminals is 1.36 N-m (12 lb-in).

¹ Packaged drives will generally be factory programmed for the control scheme shown (Parameter 241 set to 2, which is a 3-wire control), and all other inputs set to default. Refer to publication 1336 PLUS-5.3 for further information.

Catalog Number Definition

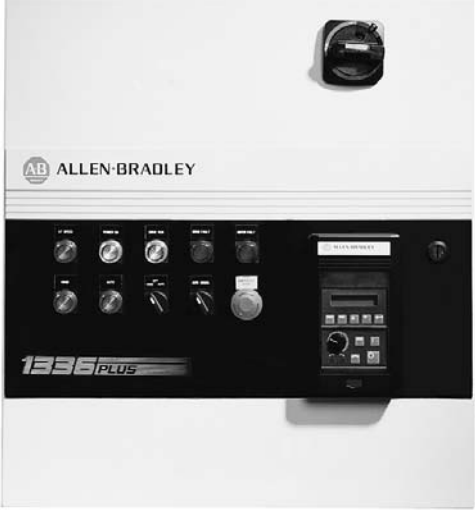

Base Drive

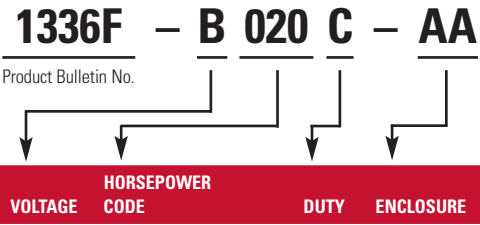

Options as Required

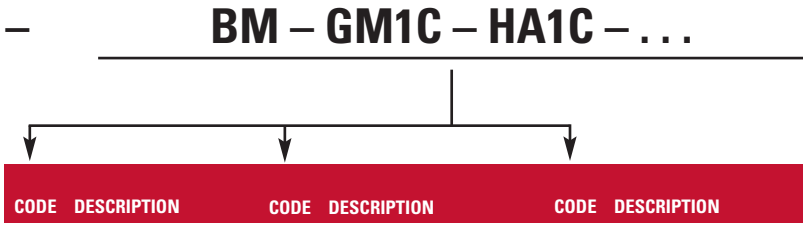

The chart shown on the next page details the segments that make up a Standard Packaged Drive Catalog Number. This chart should be used to understand the scope of the overall product offering and assembling a specific catalog number. Care should be taken to verify that the assembled catalog number qualifies as an available configuration (option combination) by referring to all pages of this section.

Selection Guide

VOLTAGE	HORSEPOWER			DUTY	ENCLOSURE
	CODE	CT	HP		
A = 230V AC	F05	0.5		C = Constant Torque	AA = NEMA Type 1
	F07	0.7			
	F10	1			
	F15	1.5			
	F20	2			
	F30	3			AF = NEMA Type 4
	F50	5			
	F07	7.5			
	F10	10			
	F15	15			
	F20	20			AJ = NEMA Type 12
	F25	25			
	F30	30			
	F40	40			
	F50	50			
	F60	60			
	F75	75			
	100	100			
	125	125			
	B = 460V AC	F05	0.5		0.5
F07		0.75	0.75		
F10		1	1		
F15		1.5	1.5		
F20		2	2		
F30		3	3	V = Variable Torque	
F50		5	5		
F75		7.5	10		
F100		10	15		
F150		15	—		
F200		20	20	AJ = NEMA Type 12	
F15		15	—		
F20		20	25		
F25		25	—		
F30		30	30		
X040		40	40		
040		—	50		
050		50	—		
X060		60	60		
060		60	75		
075		75	100		
100		100	125		
125		125	150		
X150		150	—		
150		150	200		
200		200	250		
250		250	250		
P250		250	300		
X250		—	300		
300		300	350		
P300	300	350			
350	350	400			
P350	350	400			
400	400	450			
P400	400	450			
450	450	500			
P450	450	—			
500	500	600			
600	600	—			
C = 575V AC	F10	1		C = Constant Torque	AA = NEMA Type 1
	F20	2			
	F30	3			
	F50	5			
	F75	7.5			
	F100	10			AF = NEMA Type 4
	F150	15			
	F200	20			
	025	25			
	030	30			
	040	40			AJ = NEMA Type 12
	050	50			
	060	60			
	075	75			
	100	100			
	125	125			
	150	150			
	200	200			
	250	250			
	300	300			
X300	300				
350	350				
400	400				
450	450				
500	500				
600	600				

CODE	DESCRIPTION	CODE	DESCRIPTION	CODE	DESCRIPTION
-A208	208V AC Input	-EP2	Enclosure Paint - Special, Two-Color	-L5C	Control Interface, 24V
-BA	Bypass, Auto	-EP3	Encl. Paint - Special, Three-Color	-L6C	Control Interface, 115V AC (Std.)
-BC	Bypass, Auto, SMC-Pump	-ET	Enclosure Nameplate	-L7EC	Control Int, TTL, Encoder
-BD	Bypass, Auto, SMC	-FM	Fuse Block, Motor	-L7EC	Control Int, TTL, Encoder
-BM	Bypass, Manual	-GD1C	Single Point RIO	-L8EC	Control Int, 24V, Encoder
-BP	Bypass, Manual, SMC-Pump	-GM2C	RS232/422/485, DFI	-L9EC	Control Int, 115V, Encoder
-BS	Bypass, Manual, SMC	-GM1C	Single Point RIO	-LQ	Output Reactor, NEMA 1
-CB	Circuit Breaker, Drive	-GM2C	RS232/422/485, DFI	-LR	Input Reactor, NEMA 1
-CC	Circuit Breaker, Bypass	-GM5C	DeviceNet	-LT	Input Reactor, NEMA 4/12
-CF	Control Power - Drive Only	-GM6C	Enhanced DeviceNet	-LW	Output Reactor, NEMA 4/12
-CM	Common Mode Core	-GMS1C	Single Point RIO	-MB	Blower Motor Starter
-CP	Control Power Plus 250VA	-GMS2C	RS232/422/485, DFI	-ME	Motor Time Run Meter
-CT	Control Power. Plus 500VA	-GMS5C	DeviceNet	-MH	Motor Heater Control, Remote Power
-DS	Disconnect Switch, Drive	-GMS6C	Enhanced DeviceNet	-MH2	Motor Heater Control, Local Power
-DT	Disconnect Switch, Bypass	-HABC	HIM, Blank, NEMA Type 1	-MK	Thermal Overload-Class 20
-D10	Start, Stop, Jog, A/M	-HAPC	HIM, Programmer, NEMA Type 1	-MP12A	12 Pulse Front End with Auto Transformer
-D11	H/O/A and A/M Switches	-HA1C	HIM, Analog, NEMA Type 1		
-D12	D11 Plus Pilot Lights	-HA2C	HIM, Digital, NEMA Type 1	-MP12N	12 Pulse Front End with Isolation Transformer
-D13	H/O/A Selector Switch	-HJPC	HIM, Programmer, NEMA Type 12		
-D14	D13 Plus Pilot Lights	-HJ2C	HIM, Digital, NEMA Type 1		
-D15	A/M Selector Switch	-HNSBC	HIM, Blank, Open	-MP18A	18 Pulse Front End with Auto Transformer
-D16	D15 Plus Pilot Lights	-HNSPC	HIM, Programmer, Open		
-D17	Start & Stop PBs	-HNS1C	HIM, Analog, Open	-MP18N	18 Pulse Front End with Isolation Transformer
-D18	Start, Stop A/M	-HNS2C	HIM, Digital, Open		
-D19	Start, Stop, Jog	-JC	Contacts, Control Power On		
-D21	Pilot Light Package	-JF	Contacts, Fault	-MQ2	Line Metering System, Deluxe
-D22	Pilot Light Package	-JL	PLC Hardware & Mounting	-MQ3	Line Metering System, Basic
-D31	At Speed Pilot Light	-JM	Contacts, Alarm	-MT	Thermal Overload-Class 10
-D32	Fwd/Rev Selector Switch	-JR	Contacts, Run		
-D41	Drive & Bypass Lights	-JS	SLC Hardware & Mounting	-MX3	Conformal Coating
-D42	Auto Bypass Enable Off/On S.S. and Bypass PL.	-JT	Contacts, At Speed	-N3	Analog Input Isolator
-D51	Drive Disable PB (Contactor)	-KD	Contactor, Drive Input	-N4C	Transducer, Local Command
-D52	Drive Disable PB (Enable)	-KM	Contactor, Drive Output	-N4T	Transducer, Local Trim
-D61	Speed Pot	-LA1C	Two Analog Outputs, One Input	-N5C	Transducer, Remote Command
-D91	800T Conversion	-LA2C	Two Analog Inputs	-N5T	Transducer, Remote Trim
-EB	Voltage Barrier	-LA3C	Two Analog Outputs	-N6A	RTD Protection, 120 Ohm Nickel
-EC	Enclosure Filtered Door Openings	-LA4C	One Analog Input and Output	-N7A	RTD Protection 10 Ohm Copper
-EF1	Enclosure Floor Stand, 12"	-LA5C	Two Analog Outputs, One Input	-N8A	RTD Protection, 100 Ohm Platinum
-EF2	Enclosure Floor Stand, 24"	-LAGC	Two Analog Inputs	-UL	UL Panel Recognition
-EG	Enclosure Filters and Gasketing	-LA7C	Two Analog Inputs		
-EH	Enclosure Heater, Remote Power	-L4C	Control Interface, TTL		
-EH2	Enclosure Heater, Local Power				
-EP1	Enclosure Paint - Special, One-Color				

NOTE: Not all options are available with all ratings.

All Base Drive Catalog Numbers listed on the following pages include:

- A Standard Drive
- Drive Branch Fusing
- A 115V AC Control Interface Card (Option -L6)
- Enclosure of Choice

Selection Guide

230V Constant Torque Drives and Enclosures 1, 2

Frame	Drive Rating Nominal HP	Amps	NEMA Type 1 (IP20) General Purpose Code	NEMA Type 4 (IP65) Resists Water and Dust Code	NEMA Type 12 (IP54) Industrial Use, Dust Tight Code
A1	1/2	2.3	AF05C-AA	AF05C-AF	AF05C-AJ
	3/4	3.0	AF07C-AA	AF07C-AF	AF07C-AJ
	1	4.5	AF10C-AA	AF10C-AF	AF10C-AJ
A2	1 1/2	6.0	AF15C-AA	AF15C-AF	AF15C-AJ
	2	8.0	AF20C-AA	AF20C-AF	AF20C-AJ
A3	3	12.0	AF30C-AA	AF30C-AF	AF30C-AJ
	5	18.0	AF50C-AA	AF50C-AF	AF50C-AJ
B1	7 1/2	27.0	A007C-AA	A007C-AF	A007C-AJ
B2	10	34.0	A010C-AA	A010C-AF	A010C-AJ
	15	48.0	A015C-AA	A015C-AF	A015C-AJ
C	20	65.0	A020C-AA	A020C-AF	A020C-AJ
	25	77.0	A025C-AA	A025C-AF	A025C-AJ
	30	80.0	A030C-AA	A030C-AF	A030C-AJ
D	40	120.0	A040C-AA	A040C-AF	A040C-AJ
	50	150.0	A050C-AA	A050C-AF	A050C-AJ
	60	180.0	A060C-AA	A060C-AF	A060C-AJ
E	75	240.0	A075C-AA	A075C-AF	A075C-AJ
	100	292.0	A100C-AA	A100C-AF	A100C-AJ
	125	325.0	A125C-AA	A125C-AF	A125C-AJ

460V Constant Torque Drives and Enclosures 1, 3

Frame	Drive Rating Nominal HP	Amps	NEMA Type 1 (IP20) General Purpose Code	NEMA Type 4 (IP65) Resists Water and Dust Code	NEMA Type 12 (IP54) Industrial Use, Dust Tight Code
A1	1/2	1.1	BF05C-AA	BF05C-AF	BF05C-AJ
	3/4	1.6	BF07C-AA	BF07C-AF	BF07C-AJ
	1	2.1	BF10C-AA	BF10C-AF	BF10C-AJ
	1 1/2	2.8	BF15C-AA	BF15C-AF	BF15C-AJ
A2	2	3.8	BF20C-AA	BF20C-AF	BF20C-AJ
	3	5.3	BF30C-AA	BF30C-AF	BF30C-AJ
A3	5	8.4	BF50C-AA	BF50C-AF	BF50C-AJ
A4	7 1/2	14.0	BF75C-AA	BF75C-AF	BF75C-AJ
	10	17.5	BF100C-AA	BF100C-AF	BF100C-AJ
	15	24.0	BF150C-AA	BF150C-AF	BF150C-AJ
	20	27.0	BF200C-AA	BF200C-AF	BF200C-AJ
B1	15	24.2	B015C-AA	B015C-AF	B015C-AJ
B2	20	31.0	B020C-AA	B020C-AF	B020C-AJ
	25	39.0	B025C-AA	B025C-AF	B025C-AJ
	30	45.0	B030C-AA	B030C-AF	B030C-AJ
C	40	59.0	B040C-AA	B040C-AF	B040C-AJ
	50	75.0	B050C-AA	B050C-AF	B050C-AJ
	60	77.0	BX060C-AA	BX060C-AF	BX060C-AJ
D	60	85.0	B060C-AA	B060C-AF	B060C-AJ
	75	106.0	B075C-AA	—	B075C-AJ
	100	138.0	B100C-AA	—	B100C-AJ
	125	173.0	B125C-AA	—	B125C-AJ
	150	180.0	BX150C-AA	—	BX150C-AJ
E	150	199.0	B150C-AA	—	B150C-AJ
	200	263.0	B200C-AA	—	B200C-AJ
	250	325.0	B250C-AA	—	B250C-AJ
F	250	325.0	BP250C-AA	—	BP250C-AJ
	300	360.0	BP300C-AA	—	BP300C-AJ
	350	425.0	BP350C-AA	—	BP350C-AJ
	400	475.0	BP400C-AA	—	BP400C-AJ
	450	527.0	BP450C-AA	—	—
G	300	360.0	B300C-AA	—	B300C-AJ
	350	425.0	B350C-AA	—	B350C-AJ
	400	475.0	B400C-AA	—	B400C-AJ
	450	525.0	B450C-AA	—	B450C-AJ
	500	590.0	B500C-AA	—	B500C-AJ
	600	670.0	B600C-AA	—	B600C-AJ

¹ The basic drive does not include a Control Power Transformer. If local 115V AC power is not available, refer to options **CF**, **CP** and **CT**.

² The drive rating is based on a nominal voltage of 240 volts and a carrier frequency of 4kHz at altitudes of 1,000 meters or less. Refer to the Drive Derating Guidelines in the Standard Drives section.

³ The drive rating is based on a nominal voltage of 480 volts and a carrier frequency of 4kHz at altitudes of 1,000 meters or less. Refer to the Drive Derating Guidelines in the Standard Drives section.

Selection Guide

460V Variable Torque Drives and Enclosures 1, 2, 4

Frame	Drive Rating Nominal HP	Amps	NEMA Type 1 (IP20) General Purpose Code	NEMA Type 4 (IP65) Resists Water and Dust Code	NEMA Type 12 (IP54) Industrial Use, Dust Tight Code
A1	1/2	1.2	BF05V-AA	BF05V-AF	BF05V-AJ
	3/4	1.7	BF07V-AA	BF07V-AF	BF07V-AJ
	1	2.3	BF10V-AA	BF10V-AF	BF10V-AJ
	1 1/2	3.0	BF15V-AA	BF15V-AF	BF15V-AJ
A2	2	4.0	BF20V-AA	BF20V-AF	BF20V-AJ
	3	6.0	BF30V-AA	BF30V-AF	BF30V-AJ
A3	5	9.0	BF50V-AA	BF50V-AF	BF50V-AJ
A4	10	17.5	BF75V-AA	BF75V-AF	BF75V-AJ
	15	25.0	BF100V-AA	BF100V-AF	BF100V-AJ
	20	24.0	BF200V-AA	BF200V-AF	BF200V-AJ
B2	25	34.0	B020V-AA	B020V-AF	B020V-AJ
	30	48.0	B030V-AA	B030V-AF	B030V-AJ
C	40	59.0	BX040V-AA	BX040V-AF	BX040V-AJ
	50	65.0	B050V-AA	B050V-AF	B050V-AJ
	60	77.0	BX060C-AA	BX060V-AF	BX060V-AJ
D	75	96.0	B060V-AA	—	B060V-AJ
	100	120	B075V-AA	—	B075V-AJ
	125	150	B100V-AA	—	B100V-AJ
	150	180	BX125V-AA	—	BX125V-AJ
E	200	240	B150V-AA	—	B150V-AJ
	250	292	B200V-AA	—	B200V-AJ
	250	325	B250V-AA	—	B250V-AJ
F	300	360	BP250V-AA	—	BP250V-AJ
	350	425	BP300V-AA	—	BP300V-AJ
	400	475	BP350V-AA	—	BP350V-AJ
	450	532	BP400V-AA	—	BP400V-AJ
G	300	360	BX250V-AA	—	BX250V-AJ
	350	425	B300V-AA	—	B300V-AJ
	400	475	B350V-AA	—	B350V-AJ
	450	525	B400V-AA	—	B400V-AJ
	500	590	B450V-AA	—	B450V-AJ
	600	670	B500V-AA	—	B500V-AJ

575V Constant and Variable Torque Drives and Enclosures 1, 3

Frame	Drive Rating Nominal HP	Amps	NEMA Type 1 (IP20) General Purpose Code	NEMA Type 4 (IP65) Resists Water and Dust Code	NEMA Type 12 (IP54) Industrial Use, Dust Tight Code
A4	1	2.0	CF10C-AA	CF10C-AF	CF10C-AJ
	2	4.0	CF20C-AA	CF20C-AF	CF20C-AJ
	3	6.0	CF30C-AA	CF30C-AF	CF30C-AJ
	5	8.0	CF50C-AA	CF50C-AF	CF50C-AJ
	7 1/2	10.0	CF75C-AA	CF75C-AF	CF75C-AJ
	10	12.0	CF100C-AA	CF100C-AF	CF100C-AJ
	15	19.0	CF150CAA	CF150C-AF	CF150C-AJ
	20	24.0	CF200C-AA	CF200C-AF	CF200C-AJ
C	25	30.0	C025C-AA	C025C-AF	C025C-AJ
	30	35.0	C030C-AA	C030C-AF	C030C-AJ
	40	45.0	C040C-AA	C040C-AF	C040C-AJ
	50	57.0	C050C-AA	C050C-AF	C050C-AJ
	60	62.0	C060C-AA	C060C-AF	C060C-AJ
D	75	85.0	C075C-AA	—	C075C-AJ
	100	109	C100C-AA	—	C100C-AJ
	125	138	C125C-AA	—	C125C-AJ
E	150	168	C150C-AA	—	C150C-AJ
	200	252	C200C-AA	—	C200C-AJ
	250	284	C250C-AA	—	C250C-AJ
	300	300	CX300C-AA	—	CX300C-AJ
G	300	300	C300C-AA	—	C300C-AJ
	350	350	C350C-AA	—	C350C-AJ
	400	400	C400C-AA	—	C400C-AJ
	450	450	C450C-AA	—	C450C-AJ
	500	500	C500C-AA	—	C500C-AJ
	600	600	C600C-AA	—	C600C-AJ

¹ The basic drive does not include a Control Power Transformer. If local 115V AC power is not available, refer to options **CF**, **CP** and **CT**.

² The drive rating is based on a nominal voltage of 480 volts and a carrier frequency of 4kHz at altitudes of 1,000 meters or less. Refer to the Drive Derating Guidelines in the Standard Drives section.

³ The drive rating is based on a nominal voltage of 600 volts and a carrier frequency of 4kHz at altitudes of 1,000 meters or less. Refer to the Drive Derating Guidelines in the Standard Drives section.

⁴ When choosing horsepower related options for variable torque drives, match the option to the actual variable torque horsepower rating, not to the base catalog number. **Example:** A 15 HP VT Drive requires a 15 HP Circuit Breaker, not a 10 HP Circuit Breaker.

Motor Thermal Overload Relay Data

The **Thermal Overload Relay** (Option MT) will have the following characteristics:

- Class 10 (Bulletin 193) Relays:**
- Trip in 10 seconds or less at 600% of device current rating.
 - Have integral heater elements – Additional heater elements are not required.
 - Have auto or manual reset.
 - Have trip settings per the range chart shown below
 - If a motor outside the published adjustability range is to be used, complete motor data must be supplied at order entry.

DRIVE RATING kW (HP)	CLASS 10 ADJUSTABLE THERMAL OVERLOAD RELAY (OPTION CODE -MT) ADJUSTABLE RANGE			
	230V	460V-CT	460V-VT	575V
0.37 (0.5)	1.6-2.4 A	1-1.6 A	1-1.6 A	—
0.56 (0.75)	2.4-4 A	1-1.6 A	1-1.6 A	—
0.75 (1)	4-6 A	1.6-2.4 A	1.6-2.4 A	1.6-2.4 A
1.2 (1.5)	4-6 A	2.4-4 A	2.4-4 A	—
1.5 (2)	6-10 A	2.4-4 A	2.4-4 A	2.4-4 A
2.2 (3)	10-16 A	4-6 A	4-6 A	4-6 A
3.7 (5)	16-24 A	10-16 A	6-10 A	6-10 A
5.5 (7.5)	18-30 A	10-16 A	10-16 A	6-10 A
7.5 (10)	30-45 A	10-16 A	10-16 A	10-16 A
11 (15)	45-60 A	16-24 A	16-24 A	16-24 A
15 (20)	60-75 A	18-30 A	18-30 A	16-24 A
18.5 (25)	70-90 A	30-45 A	30-45 A	18-30 A
22 (30)	70-90 A	30-45 A	45-60 A	30-45 A
30 (40)	80-120 A	45-60 A	45-60 A	30-45 A
37 (50)	120-200 A	60-75 A	60-75 A	45-60 A
45 (60)	120-200 A	70-90 A	70-90 A	60-75 A
56 (75)	180-300 A	66-110 A	66-110 A	66-110 A
75 (100)	180-300 A	120-200 A	80-120 A	80-120 A
93 (125)	240-400 A	120-200 A	120-200 A	120-200 A
112 (150) D Frame	—	120-200 A	120-200 A	—
112 (150) E Frame	—	180-300 A	—	120-200 A
149 (200)	—	180-300 A	180-300 A	180-300 A
187 (250) 292 A	—	240-400 A	180-300 A	180-300 A
187 (250) 325 A	—	—	240-400 A	180-300 A
224 (300)	—	240-400 A	240-400 A	180-300 A
261 (350)	—	378-630 A	378-630 A	240-400 A
298 (400)	—	378-630 A	378-630 A	240-400 A
336 (450)	—	378-630 A	378-630 A	378-630 A
373 (500)	—	378-630 A	378-630 A	378-630 A
448 (600)	—	645-975 A	645-975 A	378-630 A

- Class 20 (Bulletin 592) Relays:**
- Trip in 20 seconds or less at 600% of device current rating.
 - Must be manually reset.
 - Can be programmed for Class 20 operation by choosing the appropriate heater elements from the A-B Industrial Control Catalog – Publication A113, or the chart on the next page.
 - Can also be programmed for Class 10 and 30 operation by choosing the appropriate heater elements from the A-B Industrial Control Catalog – Publication A113.

Selection Guide

Heater Element Selection

The **Thermal Overload Relay** (Option MK) will require the addition of thermal overload heater elements. These elements are not available as part of the Packaged Drives Program. The Class 20 chart shown below is supplied for reference purposes only. If Class 10 or 30 operation is required, refer to the A-B Industrial Control Catalog – **Publication A112** for selection guidance.

Rating	Motor Full Load Amperes for Sizing of Class 20 Heater Elements for Various Options Drive Ratings in kW (HP)								Heater Type W Number
230V 460V-CT 460V-VT 575V	0.37-3.7 (0.5-5) 0.37-3.7 (0.5-5) 0.37-3.7 (0.5-5) 0.37-3.7 (0.5-5)	5.5-7.5 (7.5-10) 5.5-18.5 (7.5-25) 5.5-18.5 (7.5-25) 5.5-22 (7.5-30)	11-18.5 (15-25) 22-30 (30-40) 22-30 (30-40) 30-45 (40-60)	22-37 (30-50) 37-75 (50-100) 37-75 (50-100) 56-93 (75-125)	45 (60) 93-112 (125-150) 93-112 (125-150) 112 (150)	56-75 (75-100) 149-187 (200-250) 149-187 (200-250) 149-224 (200-300)	93 (125) 224 (300) 224 (300) 261-336 (350-450)	— 261-373 (350-500) 261-373 (350-500) 373 (500)	
W20	0.49	W20
W21	0.54	W21
W22	0.60	W22
W23	0.67	70	W23
W24	0.74	75	127	...	W24
W25	0.84	W25
W26	0.90	115	W26
W27	1.00	43	...	78	125	W27
W28	1.10	45	...	85	135	W28
W29	1.22	50	...	94	147	W29
W30	1.31	54	...	104	165	W30
W31	1.43	59	...	114	179	W31
W32	1.55	65	...	125	196	W32
W33	1.66	70	...	139	216	W33
W34	1.80	75	127	150	232	W34
W35	1.97	81	138	160	260	W35
W36	2.12	89	151	175	287	W36
W37	2.33	98	166	195	315	W37
W38	2.59	110	183	215	350	W38
W39	2.84	120	198	235	385	W39
W40	3.15	132	218	260	420	W40
W41	3.46	143	239	298	465	W41
W42	3.84	155	260	320	515	W42
W43	4.27	170	285	350	570	W43
W44	4.73	193	310	380	630	W44
W45	5.36	415	...	W45
W46	5.82	455	...	W46
W47	6.33	500	...	W46
W48	6.97	550	...	W48
W49	7.63	W49
W50	8.49	8.45	W50
W51	9.24	9.29	W51
W52	10.1	10.3	W52
W53	11.1	11.4	W53
W54	12.2	12.5	W54
W55	13.6	13.7	W55
W56	14.6	15.0	W56
W57	15.7	16.3	W57
W58	17.2	17.6	W58
W59	18.9	18.9	W59
W60	20.5	20.9	21.1	W60
W61	22.2	22.9	23.2	25.1	W61
W62	24.3	25.0	25.7	27.5	W62
W63	...	27.6	28.5	30.5	W63
W64	...	30.0	30.5	33.5	W64
W65	...	32.0	33.0	36.5	W65
W66	...	34.0	35.5	40.0	43.0	W66
W67	...	37.0	38.5	44.0	47.0	W67
W68	...	39.0	41.5	48.5	51	W68
W69	...	41.0	45.0	53	56	W69
W70	48.5	58	61	W70
W71	53	62	66	W71
W72	56	67	72	W72
W73	58	72	77	W73
W74	60	77	83	W74
W75	62	82	89	W75
W76	88	95	W76
W77	94	102	W77
W78	98	108	W78
W79	102	116	W79
W80	108	123	W80
W81	117	130	W81
W82	125	137	W82
W83	150	W83
W84	160	W84
W85	165	W85

Table 181¹

Table 195¹

¹ Heater element selection tables taken from A-B Industrial Control Catalog – **Publication A113**.

Listed in the chart below are possible option combination conflicts that may occur when selecting 1336 PLUS II Packaged Drive Options.

Option Selection Rules			Option Selection Rules		
Option	Must Be Used With...	Cannot Be Used With...	Option	Must Be Used With...	Cannot Be Used With...
A208	230V Base Drives	460 or 575V Base Drives	HABC	AA	AF, AJ, GD1C, GD2C, GU6C, HAPC, HA1C, HA2C, HJPC, HJ2C
AA		AF, AJ, HJPC, HJ2C	HAPC	AA	AF, AJ, GD1C, GD2C, GU6C, HABC, HA1C, HA2C, HJPC, HJ2C
AF		AA, AJ, HABC, HAPC, HA1C, HA2C	HA1C	AA	AF, AJ, D10, D17, D18, D19, GD1C, GD2C, GU6C, HABC, HAPC, HA2C, HJPC, HJ2C
AJ		AA, AF, HABC, HAPC, HA1C, HA2C	HA2C	AA	AF, AJ, D10, D17, D18, D19, GD1C, GD2C, GU6C, HABC, HAPC, HA1C, HJPC, HJ2C
BA	JF	BC, BD, BM, BP, BS, KM, MK, MT	HNSBC		HNSPC, HNS1C, HNS2C, GMS1C, GMS2C, GMS5C
BC	JF	BA, BD, BM, BP, BS, KM, MK, MT	HNSPC		HNSBC, HNS1C, HNS2C, GMS1C, GMS2C, GMS5C
BD	JF	BA, BC, BM, BP, BS, KM, MK, MT	HNS1C		HNSBC, HNSPC, HNS2C, GMS1C, GMS2C, GMS5C
BM	JF	BA, BC, BD, BP, BS, KM, MK, MT	HNS2C		HNSBC, HNSPC, HNS1C, GMS1C, GMS2C, GMS5C
BP	JF	BA, BC, BD, BM, BS, KM, MK, MT	HJPC	AF or AJ	AA, GD1C, GD2C, GU6C, HABC, HAPC, HA1C, HA2C, HJ2C
BS	JF	BA, BC, BD, BM, BP, KM, MK, MT	HJ2C	AF or AJ	AA, D10, D17, D18, D19, GD1C, GD2C, GU6C, HABC, HAPC, HA1C, HA2C, HJ2C
CB		DS	JC		
CC	one BA, BC, BD, BM, BP or BS	DT	JF		
CF		CP, CT	JL		JS
CM		CF, CT	JM		
CP		CF, CP	JR		
CT		CB	JS		JL
DS		CC	JT		
DT	one BA, BC, BD, BM BP or BS		KD		KM
D10		D11-D19, HA1C, HA2C, HJ2C	KM	JF	BA, BC, BD, BM, BP, BS, KD
D11		D10, D12-D19	LA1C	—	LA3C, LA4C, LA5C
D12		D10, D11, D13-D19, L4C, L7EC	LA2C	—	D61, LA6C, LA7C, N3, N4C, N4T, N5C, N5T
D13		D10-D12, D14-D19	LA3C	—	LA1C, LA4C, LA5C
D14		D10-D13, D15-D19, L4C, L7EC	LA4C	—	LA1C, LA3C, LA5C
D15		D10-D14, D16-D19	LA5C	—	LA1C, LA3C, LA4C
D16		D10-D15, D17-D19, L4C, L7EC	LA6C	—	D61, LA2C, LA7C, N3, N4C, N4T, N5C, N5T
D17		D10-D16, D18, D19, HA1C, HA2C, HJ2C	LA7C	—	D61, LA2C, LA6C, N3, N4C, N4T, N5C, N5T
D18		D10-D17, D19, HA1C, HA2C, HJ2C	L4C		D12, D14, D16, L5C, L7EC, L8EC, L9EC
D19		D10-D18, HA1C, HA2C, HJ2C	L5C		L4C, L7EC, L8EC, L9EC
D21		D22	L7EC		D12, D14, D16, L4C, L5C, L8EC, L9EC
D22	one BA, BC, BD, BM, BP, BS, MK or MT	D21	L8EC		L4C, L5C, L7EC, L9EC
D31		D32	L9EC		L4C, L5C, L7EC, L8EC
D32		D31, BA, BC, BD, BM, BP, BS, CC, DT, FM, HA1C, HA2C, HJ2C	LQ	AA	AF, AJ, LT, LW
D41	one BA, BC, BD, BM, BP or BS	D42	LR	AA	AF, AJ, LT, LW
D42	one BA, BC, BD	D41, BM, BP, BS	LT	AF or AJ	AA, LR, LQ
D51	one BA, BC, BD, BM, BP, BS or KM	D52	LW	AF or AJ	AA, LR, LQ
D52		D51, BA, BC, BD, BM, BP, BS	MB	7.5 HP or larger	5 HP or smaller
D61		HA1C, HA2C, HJ2C, LA2C, LA6C, LA7C	ME	JR	
D91	At least one: D10-19, D21-22, D31-32, D41-42, D51 or D52		MH	JR	MH2
EB			MH2	JR, one of CF, CP, CT	MH
EC	AA	AF, AJ, EG	MK		BA, BC, BD, BM, BP, BS, MT
EF1	Wall Mounting Enclosures (Frames A-C)	B060C-B600C, B060V-B500V, C075C-C600C, EF2 (Frames D-G)	MT		BA, BC, BD, BM, BP, BS, MK
EF2	Wall Mounting Enclosures (Frames A-C)	B060C-B600C, B060V-B500V, C075C-C600C, EF1 (Frames D-G)	MP12A		LR, LT, MP12N, MP18A, MP18N
EG	AA	AF, AJ, EC	MP12N		MP12A, MP18A, MP18N
EH	JR	EH2	MP18A		LR, LT, MP12A, MP12N, MP18N
EH2	JR, one of CF, CP, CT	EH	MP18N		MP12A, MP12N, MP18A
EN910C		EN935C, EN945C	MQ2		MQ3
EN935C		EN910C, EN945C	MQ3		MQ2
EN945C		EN910C, EN935C	MX3C		
EP1		EP2, EP3	N3		LA2C, LA6C, LA7C, N4C, N4T, N5C, N5T
EP2		EP1, EP3	N4C		LA2C, LA6C, LA7C, N3, N4T, N5C, N5T
EP3		EP1, EP2	N4T		LA2C, LA6C, LA7C, N3, N4C, N5C, N5T
ET			N5C		LA2C, LA6C, LA7C, N3, N4C, N4T, N5T
FM	one BA, BC, BD, BM, BP or BS		N5T		LA2C, LA6C, LA7C, N3, N4C, N4T, N5C
GD1C		GM1C, GMS1C, GD2C, GU6C, HABC, HAPC, HA1C, HA2C, HJBC, HJPC, HJ2C	N6A		N7A, N8A
GD2C		GM2C, GMS2C, GD1C, GU6C, HABC, HAPC, HA1C, HA2C, HJBC, HJPC, HJ2C	N7A		N6A, N8A
GM1C		GD1C, GM2C, GM5C, GMS1C Frame A Drives	N8A		N6A, N7A
GM2C		GD2C, GM1C, GM5C, GMS2C Frame A Drives	UL		
GM5C		GM1C, GM2C, GMS5C Frame A Drives			
GM6C		GM1C, GM2C, GM5C, GU6C, GMS6C Frame A Drv			
GMS1C		GD1C, GM1C, GMS2C, GMS5C, HNSBC, HNSPC, HNS1C, HNS2C			
GMS2C		GD2C, GM2C, GMS1C, GMS5C, HNSBC, HNSPC, HNS1C, HNS2C			
GMS5C		GM5C, GMS1C, GMS2C, HNSBC, HNSPC, HNS1C, HNS2C			
GMS6C		GM6C, GMS1C, GMS2C, GMS5C, HNSBC, GU6C, HNSPC, HNS1C, HNS2C			
GU6C	24V DC user supplied power	GM6C, GMS6C, GD1C, GD2C, HABC, HAPC, HA1C, HA2C, HJBC, HJPC, HJ2C			

Drawing Sample

Page 1 – Drive and Power Distribution

Each Packaged Drive ships with a set of order specific computer generated schematics. Though a given drive package may be configured and ordered as desired by the customer, the drawing information remains consistent. This is especially helpful when multiple drive ratings and/or different configurations are ordered. The following pages illustrate a typical set of 1336 PLUS II Standard Packaged Drive schematics.

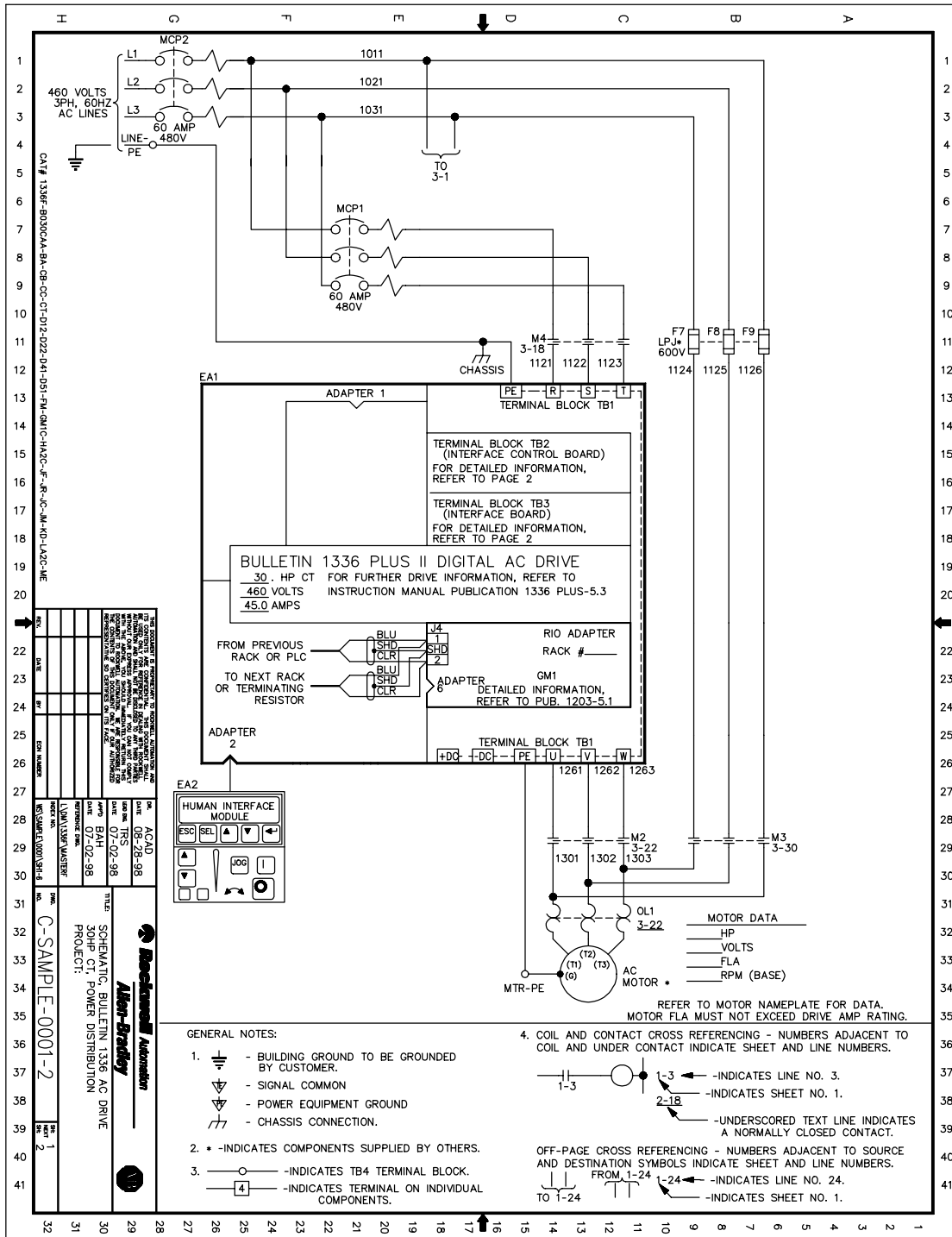

The Drive and Power Distribution page of the drawings contains the 1336 PLUS II drive, the heart and brains of the system, and all the power related components. The power distribution scheme is determined by the catalog number options chosen. Any Human Interface Modules or drive mounted options located within the drive package will also be shown on this page. Motor data will be shown if supplied with the order or if an Allen-Bradley motor is ordered.

Page 4 – Enclosure, Panel Layout and Data Nameplate

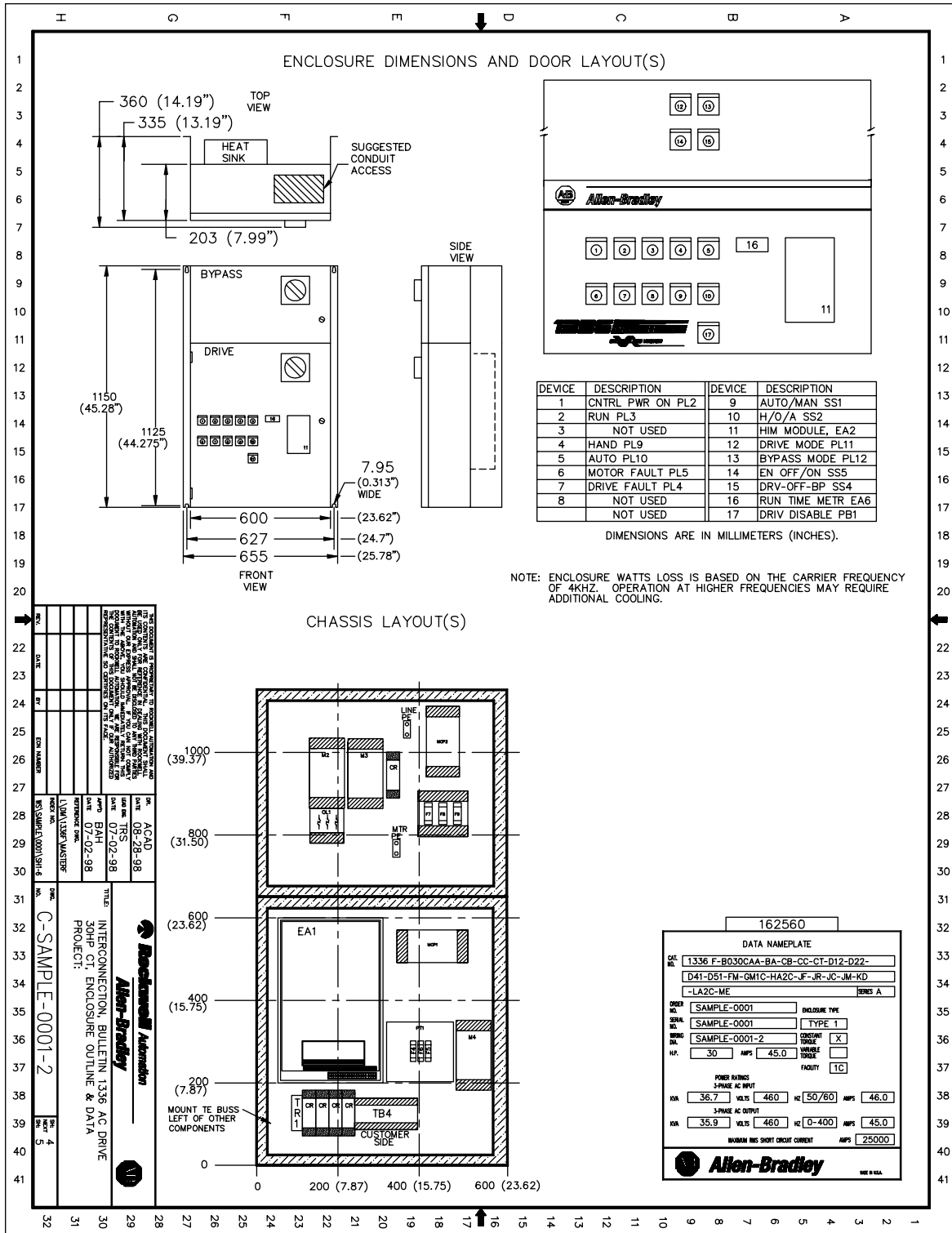

This page of the drawing package provides all the necessary enclosure information including: dimensions, conduit access, operator devices and location, and panel layout. The actual drive system data nameplate is also shown on this sheet – this is helpful for customers who might have multiple drives in one location and need to quickly match up the correct documentation for each actual drive by comparing nameplates.

REPLACEMENT MATERIAL LIST - COMPONENTS				EXTERNAL INTERCONNECT WIRING REQUIREMENTS					
SYM.	DESCRIPTION	A-B PART NO.	MANUFACTURER/PART NO.	POWER					
EA1	DRIVE UNIT	N/A	1336F-B030-AN-EN	SEE INSTRUCTION MANUAL FOR CABLE CLASSES					
EA1	115VAC CNTRL	161428	AB/1336-L6	INTERCONNECTION INFORMATION					
MCP1	CIRCUIT PROT	160912	WEST./GMCP060J2C	CURR CLASS	WIRE NO.	SOURCE	EXPLANATION	TERMINAL WIRE RANGE	
F4,F5	FUSE	149859	BUSSMANN-KLDR7.5	2	GRND	LINE-PE	GROUND EQMT CONDUCTOR		
F6	FUSE	142917	BUSSMANN-FNM8						
PT1	CTRL TFMR	162174	HEAVY DUTY-E850-3PBX						
SS2	H O A SEL SW	N/A	AB/800EP-SM32C24LX22						
SS1	A M SEL SW	N/A	AB/800EP-SM224LX01						
PL9/10	PILOT LIGHT	N/A	AB/800EP-PL54RL5	SEE	2	N/A	1T1 OLI-T1	AC MOTOR #10-4 Ga	
PL2	PILOT LIGHT	N/A	AB/800EP-PL74RL5	MTR			1T2 OLI-T2		
PL3	PILOT LIGHT	N/A	AB/800EP-PL44RL5	N/P			1T3 OLI-T3		
PL4	PILOT LIGHT	N/A	AB/800EP-PL44RL5				FRAME MTR-PE		
PL5	PILOT LIGHT	N/A	AB/800EP-PL44RL5						
PL11	PILOT LIGHT	N/A	AB/800EP-PL54RL5						
PL12	PILOT LIGHT	N/A	AB/800EP-PL54RL5	46	2	L1	MCP2-L1 INCOMING	#14-4 Ga	
RB1	DRIVE DISABLE	N/A	AB/800EP-MT44LX02				L2 MCP2-L2	460 V LINES	
EA2	HIM MODULE	171754	AB/1201-HA2				L3 MCP2-L3		
OR6	RELAY	101215	AB/700-HC24A1	CONTROL					
CR7	RELAY	101215	AB/700-HC24A1	SEE INSTRUCTION MANUAL FOR CABLE CLASSES					
CR11	RELAY	101215	AB/700-HC24A1	CLASSES 5 AND 6 ARE CONTROL WIRES, 15 AMPS OR LESS					
CR10	RELAY	101215	AB/700-HC24A1	INTERCONNECTION INFORMATION					
SS4	DRV-OFF-BYP	N/A	AB/800FP-SM32C24LX11	CLASS NO.	WIRE NO.	SOURCE	EXPLANATION	TERMINAL WIRE RANGE	CABLE TYPE
SS5	AUT BYP ENABL	N/A	AB/800EP-SM224LX10	5	2223	TB4-15	AUTO RUN CONTACT	#22-14 Ga.	PER CODE
CR14	RELAY	101215	AB/700-HC24A1						
M2	CONTACTOR	120482	AB/100-A45						
M3	CONTACTOR	120482	AB/100-A45						
OL1	OVERLOAD	138475	AB/193-CPC45						
TR1	TIMING RELAY	190475	SPR-SHUH/RZ7-FS3A-CU-23						
F7-9	MOTOR FUSE	N/A	BUSSMAN/LPJ IYPE						
M4	CONTACTOR	119058	AB/100-A60ND3						
MCP2	CIRCUIT PROT	160912	WEST./GMCP060J2C						
EA1	SINGL PNT RIO	161455	AB/1336-GM1						
EA1	ANLG OPT BRD	188604	AB/1336F-LA2						
EA6	EL TIME MTR	165413	KESSLER-ELLIS/K1884						
GENERAL WIRING NOTES				SIGNAL					
1. CUSTOMER TERMINALS ARE SIZED FOR 75°C WIRE PER NEC TABLE 310-16 (75°C)				SEE INSTRUCTION MANUAL FOR CABLE CLASSES					
2. STEEL CONDUIT IS RECOMMENDED FOR ALL WIRING CLASSES, BUT IS REQUIRED FOR SIGNAL CATEGORY CLASSES. ALUMINUM CONDUIT REQUIRES THE SAME MINIMUM SPACING AS SHOWN FOR CABLE TRAYS.				CLASSES 7 THROUGH 12 ARE SIGNAL WIRES, 5 AMPS OR LESS					
3. SPACES BETWEEN CLASSES SHOWN IN THE INSTRUCTION MANUAL IS THE MINIMUM REQUIRED FOR PARALLEL RUNS EQUAL TO OR LESS THAN 400 FEET. GREATER SPACING SHOULD BE USED WHERE POSSIBLE.				INTERCONNECTION INFORMATION					
4. No. 16 Ga. WIRE IS THE MINIMUM RECOMMENDED SIZE FOR CONTROL WIRE. POWER WIRE IS SELECTED BY CONTINUOUS MAXIMUM LOAD (FLA).				CLASS NO.	WIRE NO.	SOURCE	EXPLANATION	TERMINAL WIRE RANGE	CABLE TYPE
5. SHIELDS FOR SHIELDED SIGNAL CABLE MUST BE CONNECTED AT ONE END ONLY. THE OTHER END SHOULD BE CUT BACK AND INSULATED. IT IS RECOMMENDED THAT SHIELDS FOR SHIELDED CABLE FROM A CABINET TO AN EXTERNAL DEVICE BE CONNECTED AT THE CABINET END OF THE CABLES. SHIELDS FOR SHIELDED POWER CABLE (MOTOR LEADS) MUST BE CONNECTED AT BOTH ENDS. THE SPlicing OF SHIELDED CABLES, IF NECESSARY, SHOULD BE DONE SUCH THAT THE SHIELD(S) REMAIN CONTINUOUS AND INSULATED FROM GROUND.				7	BLUE SHLD CLR	GM1-1 GM1-S GM1-2	RIO	#24-18 Ga.	AB 1770-CD OR EQUIV

This page provides a list of the non-drive peripheral components contained in the system package. The A-B part number, vendor and vendor's part number are included. Also provided is a list of remote wiring interconnections required and the acceptable wire gauges; for power, control and signal wiring. This page has a lot of useful contractor/installer type information.

Packaging Programs

When Allen-Bradley Manufactures Your Drive Package... You Can Count On:

Enclosure Sizing

Designed to meet
NEMA standards
Sufficient heat dissipation

Factory Wired Options

Proper wire type and size
Neatly bundled and routed
Separated power, control and
signal

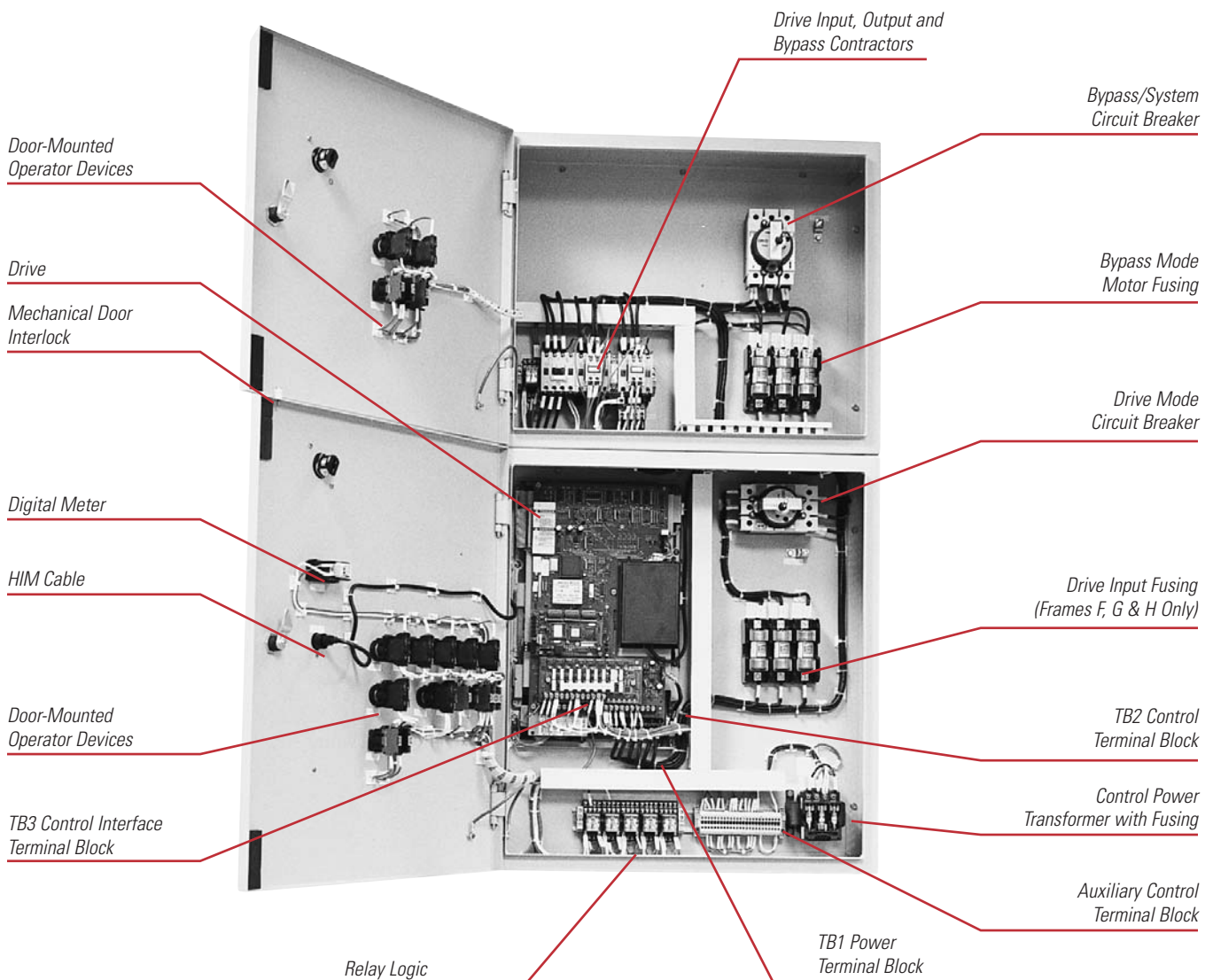

60 HP 6 Pulse 460V AC NEMA Type 1, 4 or 12 Wall Mounted Packaged Drive with Bypass

Consistent Panel Component Layouts

Proper electrical/mechanical clearances
 Lower cost customer interface wiring
 Faster troubleshooting

Provision for Mounting

Slotted tabs on small drives
 Floorplate holes on larger drives

Consistent Door Layouts

Easier operator training
 Functionality is consistent
 Aesthetically/ergonomically pleasing

Provision for Lifting

Slotted chassis holes on small drives
 Removable lifting bar on large drives

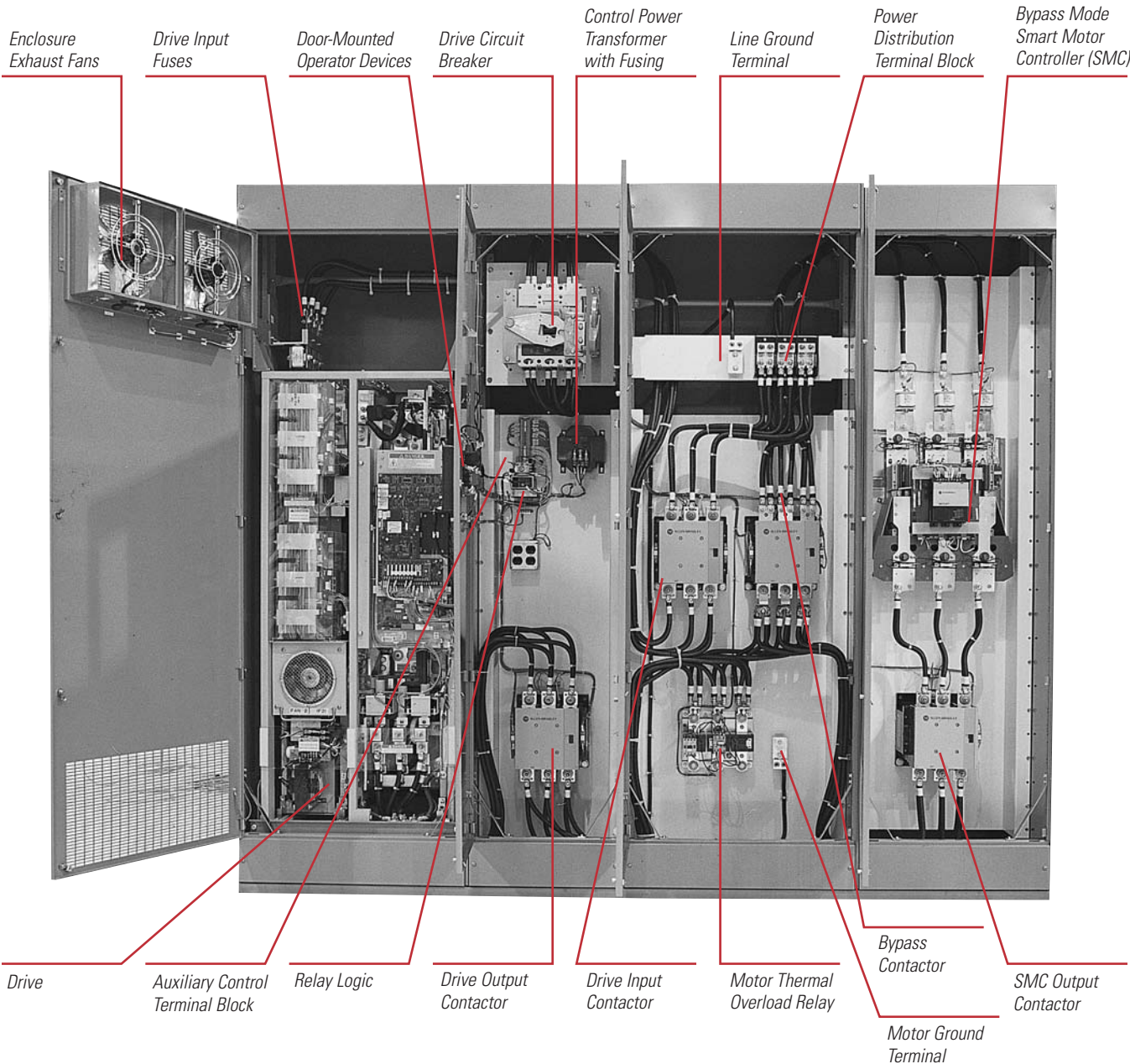

500 HP 6 Pulse 460V AC NEMA Type 1 Floor Mounted Packaged Drive with SMC Style Bypass

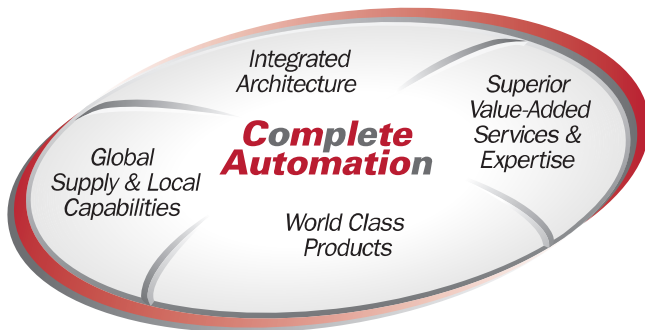

The 1336 PLUS II is a world class product that will help to provide you with a single solution for virtually all of your speed control requirements. Its common design and control interface functions will help save you time and money in set-up, integration, and maintenance of your automation system.

For Allen-Bradley Drives support, there are specialists at local sales offices and distributor locations across North America and around the world. We also offer Global Technical Services, specializing in a full spectrum of value-added services and expertise to help simplify maintenance and enhance productivity.

Rockwell Automation is committed to helping you meet ever-changing customer demands for more, less expensive product in less time. Our capabilities enable us to become your "Complete Automation"™ partner.

1336 FORCE, 1336 IMPACT, DriveTools32, Flex, SLC, SCANport, SMC, SMC Dialog Plus, SMP, CENTERLINE, Complete Automation and the Complete Automation graphic are trademarks of Rockwell Automation.

*DeviceNet is a trademark of the Open DeviceNet Vendor Association.
ControlNet is a trademark of ControlNet International, Ltd.*

www.rockwellautomation.com

Power, Control and Information Solutions Headquarters

Americas: Rockwell Automation, 1201 South Second Street, Milwaukee, WI 53204-2496 USA, Tel: (1) 414.382.2000, Fax: (1) 414.382.4444

Europe/Middle East/Africa: Rockwell Automation, Vorstlaan/Boulevard du Souverain 36, 1170 Brussels, Belgium, Tel: (32) 2 663 0600, Fax: (32) 2 663 0640

Asia Pacific: Rockwell Automation, Level 14, Core F, Cyberport 3, 100 Cyberport Road, Hong Kong, Tel: (852) 2887 4788, Fax: (852) 2508 1846