

## 1.1 CP1484, CP1485, CP1486, CP3484, CP3485, CP3486

### 1.1.1 General information

Based on state-of-the-art Intel Celeron processor technology, the X20 CPUs cover a wide spectrum of demands. They can be implemented in solutions ranging from standard applications to those requiring the highest levels of performance.

USB and Ethernet are included in every CPU. Furthermore, every CPU has an ETHERNET Powerlink connection for real-time communication.

In addition, there are up to three multi-purpose slots for additional interface modules.

- Intel Celeron 650/400/266 Performance
- Ethernet, ETHERNET Powerlink and USB onboard
- Modular expansion of interfaces
- Fan-free or exchangeable fan
- Extremely compact

### 1.1.2 Order data

	
<span>CP1484, CP1485, CP1486 <sup>1)</sup></span> <span style="margin-left: 200px;">CP3484, CP3485, CP3486 <sup>1)</sup></span>	
Model number	Short description
X20CP1484	X20 CPU, Celeron 266 comp., 32 MB DRAM, 1 MB SRAM, exchangeable application memory: CompactFlash, 1 insert slot for X20IF modules, 2 USB interfaces, 1 RS232 interface, 1 Ethernet interface 10/100 Base-T, 1 ETHERNET Powerlink interface, order program memory separately.
X20CP1485	X20 CPU, Celeron 400, 32 MB DRAM, 1 MB SRAM, exchangeable application memory: CompactFlash, 1 insert slot for X20IF modules, 2 USB interfaces, 1 RS232 interface, 1 Ethernet interface 10/100 Base-T, 1 ETHERNET Powerlink interface, order program memory separately.
X20CP1486	X20 CPU, Celeron 650, 64 MB DRAM, 1 MB SRAM, exchangeable application memory: CompactFlash, 1 insert slot for X20IF modules, 2 USB interfaces, 1 RS232 interface, 1 Ethernet interface 10/100 Base-T, 1 ETHERNET Powerlink interface, order program memory separately.

Table 1: X20 CPUs - order data

**CP1484, CP1485, CP1486, CP3484, CP3485, CP3486**

Model number	Short description
X20CP3484	X20 CPU, Celeron 266 comp., 32 MB DRAM, 1 MB SRAM, exchangeable application memory: CompactFlash, 3 insert slots for X20IF modules, 2 USB interfaces, 1 RS232 interface, 1 Ethernet interface 10/100 Base-T, 1 ETHERNET Powerlink interface, order program memory separately.
X20CP3485	X20 CPU, Celeron 400, 32 MB DRAM, 1 MB SRAM, exchangeable application memory: CompactFlash, 3 insert slots for X20IF modules, 2 USB interfaces, 1 RS232 interface, 1 Ethernet interface 10/100 Base-T, 1 ETHERNET Powerlink interface, order program memory separately.
X20CP3486	X20 CPU, Celeron 650, 64 MB DRAM, 1 MB SRAM, exchangeable application memory: CompactFlash, 3 insert slots for X20IF modules, 2 USB interfaces, 1 RS232 interface, 1 Ethernet interface 10/100 Base-T, 1 ETHERNET Powerlink interface, order program memory separately.
	<b>Program memory</b>
5CFCRD.0064-03	CompactFlash 64 MB TrueIDE SSI
5CFCRD.0128-03	CompactFlash 128 MB TrueIDE SSI
5CFCRD.0256-03	CompactFlash 256 MB TrueIDE SSI
5CFCRD.0512-03	CompactFlash 512 MB TrueIDE SSI
5CFCRD.1024-03	CompactFlash 1024 MB TrueIDE SSI
5CFCRD.2048-03	CompactFlash 2048 MB TrueIDE SSI
5CFCRD.4096-03	CompactFlash 4096 MB TrueIDE SSI
	<b>Included in delivery</b>
4A0006.00-000	Backup battery (see also section 1.1.18 "Changing the lithium battery" on page 20)
-	Interface module slot covers
X20AC0SR1	X20 locking plate (right)
X20TB12	Standard X20 terminal block (12-pin)

Table 1: X20 CPUs - order data

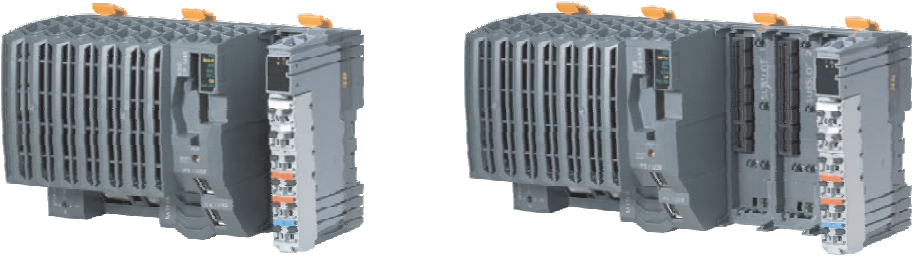
1) Modules CP1486 and CP3486 have exchangeable fan

1.1.3 Technical data

Product ID	CP1484	CP3484	CP1485	CP3485	CP1486	CP3486
Short description						
System module	CPU					
Processor	Celeron 266 comp.		Celeron 400		Celeron 650	
Interfaces	1 x RS232, 1 x Ethernet, 1 x ETHERNET Powerlink, 2 x USB					
Controller						
Fastest task class cycle time	800 µs		400 µs		200 µs	
Typical instruction cycle time	TBD µs		TBD µs		TBD µs	
Data and program code L1 cache	2 x 16 KB					
L2 cache	-		256 KB			
Standard memory RAM User RAM	32 MB SDRAM 1 MB SRAM				64 MB SDRAM 1 MB SRAM	
Remanent variables	64 KB		256 KB			
FPU	Yes					
Integrated I/O processor	Processes I/O data points in the background					
Data buffering Lithium battery Battery monitoring	At least 3 years Yes					
CompactFlash slot	1					
Real-time clock	Nonvolatile memory, resolution 1 second					
Modular interface slots	1	3	1	3	1	3
Interfaces						
Interface IF1 Type Type Maximum transfer rate	RS232 On X20 standard terminal block 115.2 kBit/s					
Interface IF2 Type Type Transfer rate Cable length	Ethernet Shielded RJ45 port 10/100 MBit/s Max. 100 m between two stations (segment length)					
Interface IF3 Fieldbus Type Type Transfer rate Cable length	ETHERNET Powerlink 100 Base-T (ANSI/IEEE 802.3) Shielded RJ45 port 100 MBit/s Max. 100 m between two stations (segment length)					
Interfaces IF4 and IF5	USB Rev. 1.1					

Table 2: X20 CPUs - technical data

**CP1484, CP1485, CP1486, CP3484, CP3485, CP3486**

Product ID	CP1484	CP3484	CP1485	CP3485	CP1486	CP3486
<b>CPU and X2X Link supply</b>						
Input voltage	24 VDC (-15 % / +20 %)					
Input current	Max. 2.2 A					
Reverse polarity protection	Yes					
Fuse	Integrated, cannot be exchanged					
<b>X2X Link supply output</b>						
Rated output power	7.0 W					
Parallel operation	Yes <sup>1)</sup>					
Redundant operation of X2X Link supply	Yes					
<b>I/O supply input</b>						
Input voltage	24 VDC (-15 % / +20 %)					
Fuse	Recommended pre-fusing max. 10 A slow-blow					
<b>I/O supply output</b>						
Rated output voltage	24 VDC					
Allowable contact load	10.0 A					
<b>General supply</b>						
Status indicators	Overload, operating status, module status					
Diagnostics Module run error Overload	Yes, with status LED and software status Yes, with status LED and software status					
Electrical isolation X2X bus supply I/O supply	Yes No					
<b>General information</b>						
Status indicators	CPU function, overtemperature, Ethernet, ETHERNET Powerlink, CompactFlash, battery					
Diagnostics CPU function Overtemperature Ethernet ETHERNET Powerlink CompactFlash Battery Fans	Yes, with status LED Yes, with status LED Yes, with status LED Yes, with status LED Yes, with status LED Yes, with status LED and software status Yes, with software status					
Visual Components capable	Yes					
ACOPOS™ capable	Yes					
Cooling	Fan-free				Fan-free with derating (see operational conditions) Exchangeable fans for entire temperature range Fan is monitored	

Table 2: X20 CPUs - technical data (cont.)

**CP1484, CP1485, CP1486, CP3484, CP3485, CP3486**

Product ID	CP1484	CP3484	CP1485	CP3485	CP1486	CP3486
Electrical isolation PLC - IF1/IF4/IF5 PLC - IF2/IF3 IF1/IF4/IF5 - IF2/IF3 IF1 - IF4/IF5 IF4 - IF5						
Power consumption - without memory card, interface module or USB	10.5 W	10.5 W	10.5 W	10.5 W	13.5 W	13.5 W
Certification	CE, C-UL-US (in development), GOST-R (in development)					
<b>Operational conditions</b>						
Operating temperature Horizontal installation	0 °C to +55 °C				0 °C to +55 °C Fan-free: 0 °C to +45 °C	
Vertical installation	0 °C to +50 °C				0 °C to +55 °C, Fan-free is not allowed	
Humidity	5 to 95%, non-condensing					
Mounting orientation	Horizontal or vertical					
Installation at altitudes above sea level 0 - 2000 m >2000 m	No derating Reduction of environmental temperature by 0.5 °C per 100 m					
Protection type	IP20					
<b>Storage and transport conditions</b>						
Temperature	-25 °C to +70 °C					
Humidity	5 to 95%, non-condensing					
<b>Mechanical characteristics</b>						
Dimensions (W x H x D) [mm]	150 x 99 x 85	200 x 99 x 85	150 x 99 x 85	200 x 99 x 85	150 x 99 x 85	200 x 99 x 85
Comment	Order program memory (CompactFlash) separately Backup battery included in delivery X20 locking plate (right) included in delivery Standard X20 terminal block (12-pin) included in delivery Interface module slot covers included in delivery					

Table 2: X20 CPUs - technical data (cont.)

- 1) In parallel operation, only 75 % of the rated power can be assumed. Please ensure that all parallel operating power supplies are switched on and off simultaneously.

### 1.1.4 X20 CPUs - status LEDs



LED	Color	Status	Description
R/E	Green	On	Application running
	Red	On	SERVICE mode
RDY/F	Yellow	On	CPU is active
	Red	On	Overtemperature
S/E	Green/red		Status/Error LED. The status of the LED is described in section "S/E LED".
EPL	Green	On	A link to the ETHERNET Powerlink remote station has been established.
		Blinking	A link to the ETHERNET Powerlink remote station has been established. The LED blinks when Ethernet activity is present on the bus.
ETH	Green	On	A link to the Ethernet remote station has been established.
		Blinking	A link to the Ethernet remote station has been established. The LED blinks when Ethernet activity is present on the bus.
CF	Yellow	On	CompactFlash OK
	Green	On	CompactFlash active
DC OK	Green	On	CPU power supply OK
	Red	On	Backup battery is empty

Table 3: X20 CPUs - CPU status indicator

#### S/E LED

The Status/Error LED is a green/red dual LED. The status LEDs can have different meanings depending on operating mode.

#### Ethernet TCP/IP mode

With Automation Studio™ Version V 2.5.3 and later, the interface can be operated as a purely Ethernet TCP/IP interface.

Green - status	Description
On	The ETHERNET Powerlink interface is operated as a pure TCP/IP interface.

Table 4: X20 CPUs status/error LED - Ethernet TCP/IP operating mode

ETHERNET Powerlink V1

Status LED		Status of the Powerlink station
Green	Red	
On	Off	The Powerlink station is running with no errors.
Off	On	A fatal system error has occurred. The error type can be read using the PLC logbook. It concerns an irreparable problem. The system cannot properly carry out its tasks. This status can only be changed by resetting the module.
Blinking alternately		The Powerlink managing node failed. This error code can only occur in controlled node operation. This means that the set station number lies within the range \$01 - \$FD.
Off	Blinking	System failure. The red blinking LED signals an error code (see Section "System halt error codes", on page 9).

Table 5: X20 CPUs status/error LED - ETHERNET Powerlink V1 operating mode

ETHERNET Powerlink V2

Color red - error	Description
On	The ETHERNET Powerlink interface has encountered an error (failed Ethernet frames, burst of collisions on the network, etc.).

Table 6: X20 CPUs status/error LED as error LED - ETHERNET Powerlink V2 operating mode

Green - status	Description
Off NOT_ACTIVE	<p><u>Managing Node (MN)</u> The bus is monitored for ETHERNET Powerlink frames. If no frame is received within the configured time window (timeout), the interface goes directly into PRE_OPERATIONAL_1 status (single flash). If, however, ETHERNET Powerlink communication is detected during these 5s, the interface goes directly into the BASIC_ETHERNET status (flickering).</p> <p><u>Controlled Node (CN)</u> The bus is monitored for ETHERNET Powerlink frames. If no frame is received within the configured time window (timeout), the interface goes directly into BASIC_ETHERNET status (flickering). If, however, ETHERNET Powerlink communication is detected during this time, the interface goes directly into the PRE_OPERATIONAL_1 status (single flash).</p>
Blinking green (approx. 10 Hz) BASIC_ETHERNET	<p>The interface is in BASIC_ETHERNET status, and is operated as a pure TCP/IP interface.</p> <p><u>Managing Node (MN)</u> This status can only be changed by resetting the interface.</p> <p><u>Controlled Node (CN)</u> If an ETHERNET Powerlink communication is detected while in this status, the interface goes into the PRE_OPERATIONAL_1 state (single flash).</p>

Table 7: X20 CPU status/error LED as status LED - ETHERNET Powerlink V2 operating mode

Green - status	Description
Single flash (approx. 1 Hz) PRE_OPERATIONAL_1	<p>The interface status is PRE_OPERATIONAL_1.</p> <p><u>Managing Node (MN)</u> The MN starts the operation of the "reduced cycle". Collisions are allowed on the bus. There is not yet any cyclic communication.</p> <p><u>Controlled Node (CN)</u> The CN waits until it receives an SoC frame and then switches to PRE_OPERATIONAL_2 status (double flash).</p>
Double flash (approx. 1 Hz) PRE_OPERATIONAL_2	<p>The interface status is PRE_OPERATIONAL_2.</p> <p><u>Managing Node (MN)</u> The MN begins with the cyclic communication (cyclic input data are not yet evaluated). The CNs are configured in this status.</p> <p><u>Controlled Node (CN)</u> In this status the interface is normally configured by the manager. After this, a command changes the status to READY_TO_OPERATE (triple flash).</p>
Triple flash (approx. 1 Hz) READY_TO_OPERATE	<p>The interface status is READY_TO_OPERATE.</p> <p><u>Managing Node (MN)</u> Normal cyclic and asynchronous communication. Received PDO data are ignored.</p> <p><u>Controlled Node (CN)</u> The configuration of the interfaces is complete. Normal cyclic and asynchronous communication. The PDO data sent corresponds to the PDO mapping used. However, cyclic data is not yet evaluated.</p>
On OPERATIONAL	<p>The interface status is OPERATIONAL.</p>
Blinking (approx. 2.5 Hz) STOPPED	<p>The interface status is STOPPED.</p> <p><u>Managing Node (MN)</u> This status is not possible for the MN.</p> <p><u>Controlled Node (CN)</u> No output data are produced and no input data are received. Only the appropriate command from the manager can enter or leave this state.</p>

Table 7: X20 CPU status/error LED as status LED - ETHERNET Powerlink V2 operating mode



System halt error codes

Incorrect configuration or defective hardware can cause a system halt error.

The error is displayed via the red error LED using four switch-on phases. The switch-on phases are either 150 ms or 600 ms long. Error code outputs are repeated cyclically after 2 seconds has passed.

- Legend:
- ... 150 ms
  - ... 600 ms
  - Pause ... 2 s delay

Error description	Error code displayed by red status LED									
Stack overflow	•	•	•	•	Pause	•	•	•	•	Pause
RAM Error	•	•	•	–	Pause	•	•	•	–	Pause
Undefined address: Access to a non-existent address	•	•	–	•	Pause	•	•	–	•	Pause
Instruction fetch memory abort: Invalid memory access during fetch instruction (e. g. UINT access of an uneven address).	•	•	–	–	Pause	•	•	–	–	Pause
Data access memory abort: Invalid memory access during data access (e. g. UINT access of an odd address).	•	–	•	•	Pause	•	–	•	•	Pause
Error programming the FPGA	•	–	–	•	Pause	•	–	–	•	Pause
Invalid station number (e. g. \$FE or \$FF)	•	–	–	–	Pause	•	–	–	–	Pause

Table 8: X20 CPUs status/error LED as error LED - system halt error codes

### 1.1.5 Status LEDs for integrated power supply

Image	LED	Color	Status	Description
	r	Green	Off	Module not supplied
			Single flash	Reset mode
			Blinking	Preoperational mode
			On	RUN mode
	e	Red	Off	Module not supplied or everything is OK
			Double flash	Indicates one of the following conditions: <ul style="list-style-type: none"> <li>• X2X link power supply is overloaded</li> <li>• I/O supply too low</li> <li>• Input voltage for X2X Link supply too low</li> </ul>
	e + r		Steady red / single green flash	Invalid firmware
	S	Yellow	Off	No RS232 activity
			On	The LED is on, when data is being sent or received via the RS232 interface
	l	Red	Off	X2X link supply in the acceptable range
On			X2X link power supply is overloaded	

Table 9: X2X CPUs - status display for integrated power supply

### 1.1.6 Operating and connection elements

#### CP1484, CP1485 and CP1486

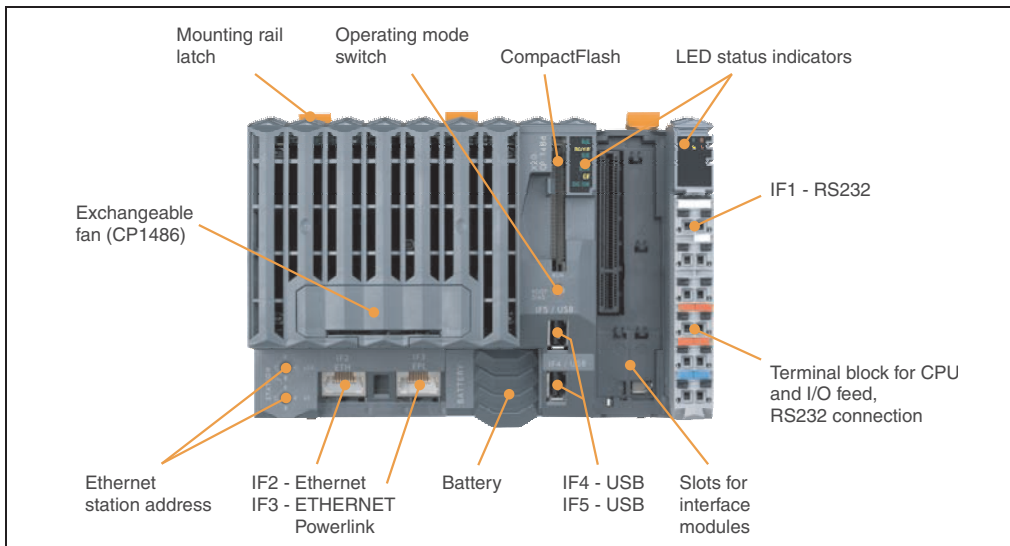

Figure 1: X2X CPUs - operating elements for CP1484, CP1485, and CP1486

**CP3484, CP3485, and CP3486**

Figure 2: X20 CPUs - operating elements for CP3484, CP3485, and CP3486

**1.1.7 Slot for program memory**

Program memory is required to operate the CPUs. The program memory is CompactFlash. It is not included with the delivery of the CPUs, instead it must be ordered as an accessory.

### 1.1.8 Operating mode switch

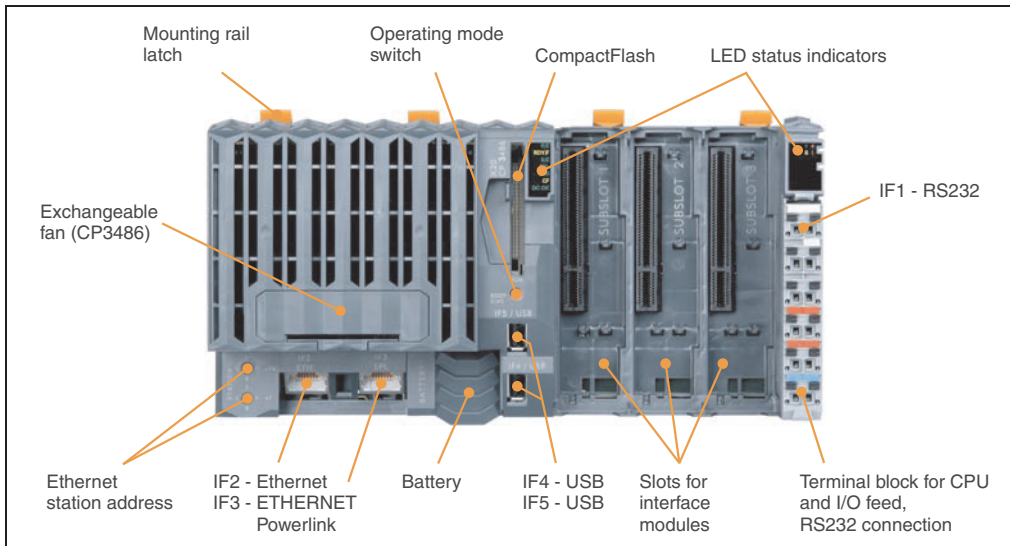
An operating mode switch is used to set the operating mode.

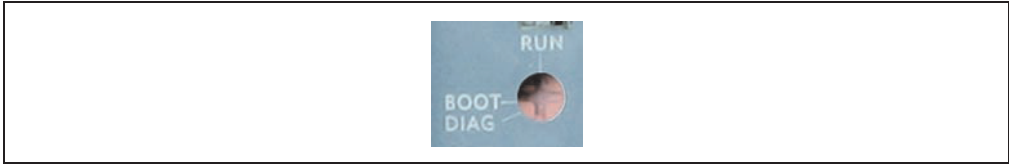

Figure 3: X20 CPUs - operating mode switch

Switch position	Operating mode	Description
BOOT	Boot	In this switch position the default B&R Automation Runtime™ (AR) is started, and the runtime system can be installed using the online interface (B&R Automation Studio™). The User Flash is deleted after the download begins.
RUN	Run	RUN mode
DIAG	Diagnostics	The CPU boots in Diagnostics mode. Program sections in User RAM and User FlashPROM are not initialized. After Diagnostics mode, the CPU always boots with a <b>warm restart</b> .

Table 10: X20 CPUs - operating modes

1.1.9 CPU supply

A power supply comes integrated in the X20 CPUs. It is equipped with a feed for the CPU, the X2X Link, and the internal I/O supply. The feed to the CPU/X2X link supply is electrically isolated. Redundancy of the X2X Link supply possible by parallel operation of multiple supply modules.

Pin assignments

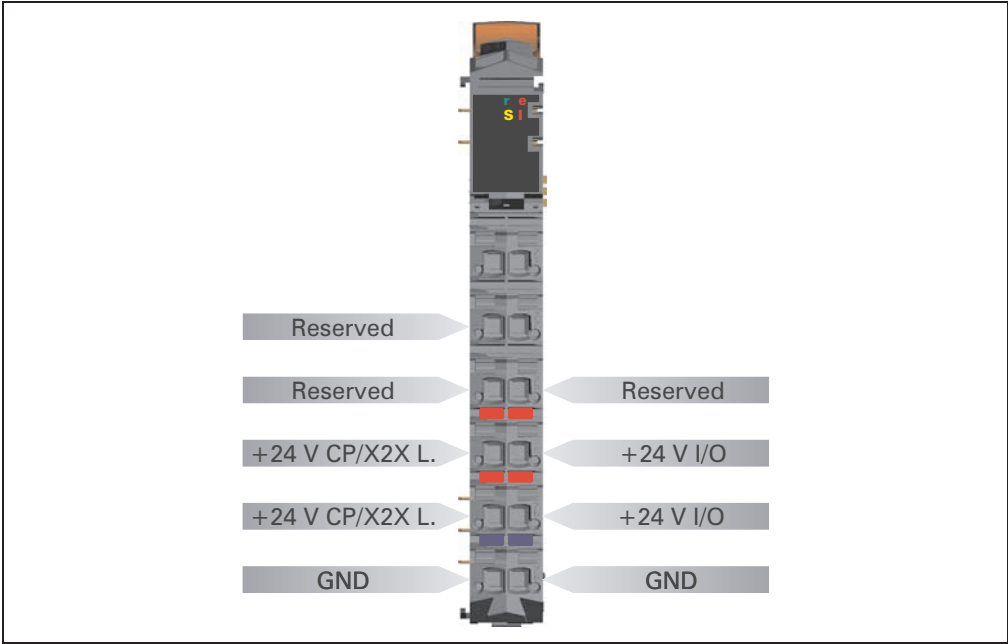

Figure 4: X20 CPUs - pin assignments - integrated power supply

Connection examples

With two separate supplies

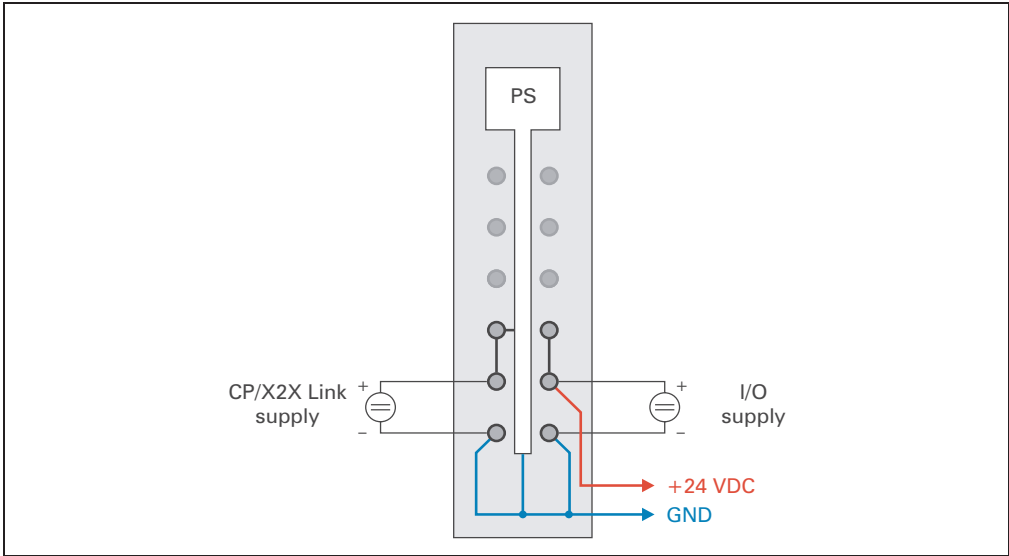

Figure 5: X20 CPUs - connection example with two separate supplies

With a supply and jumper

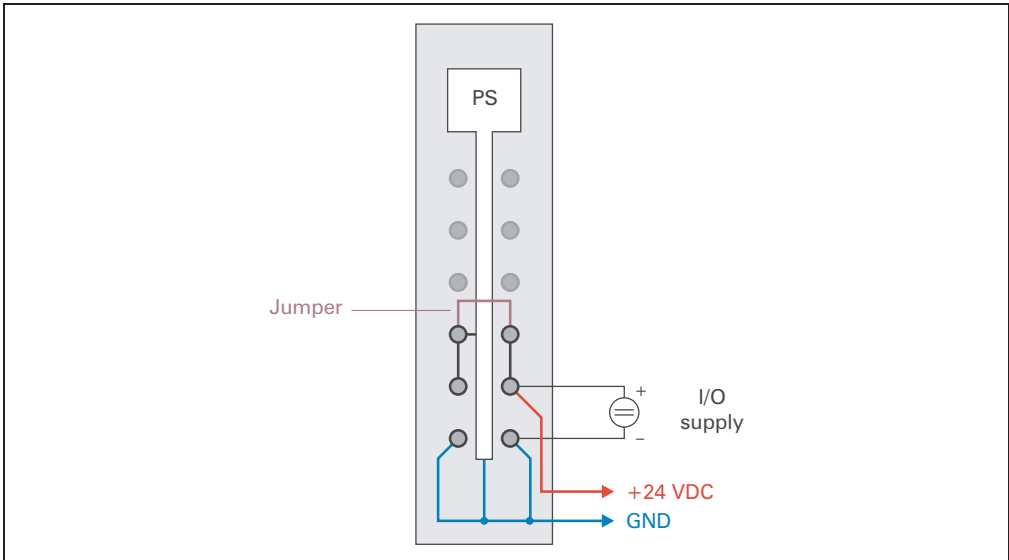

Figure 6: X20 CPUs - connection example with a supply and jumper

### 1.1.10 RS232 interface (IF1)

The RS232 interface is not electrically isolated. It can be used as an online interface for communicating with the programming device.

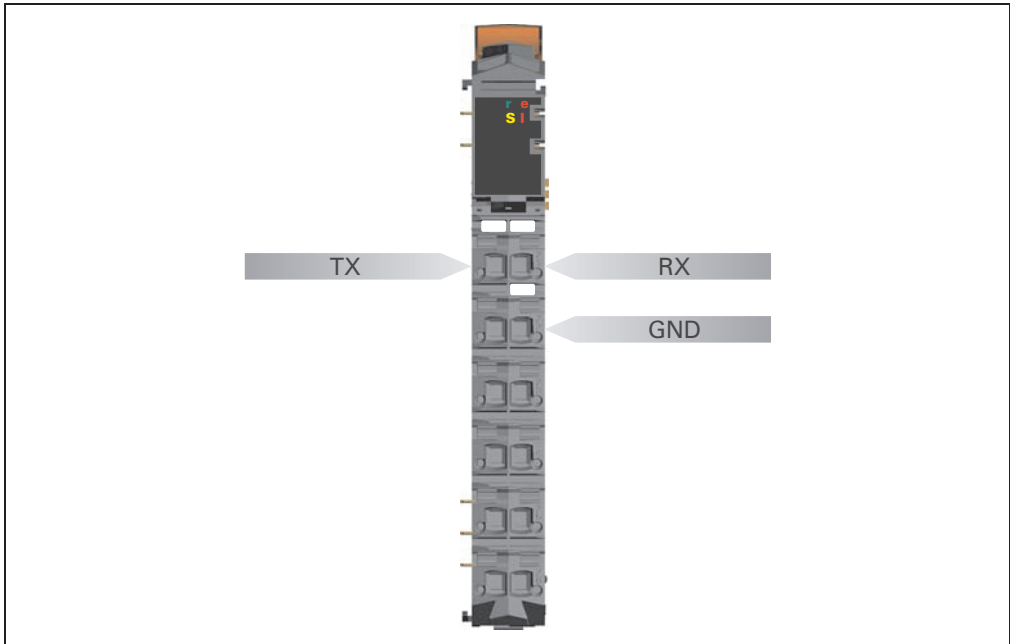

Figure 7: X20 CPUs - pin assignments - RS232 interface (IF1)

### 1.1.11 Ethernet interface (IF2)

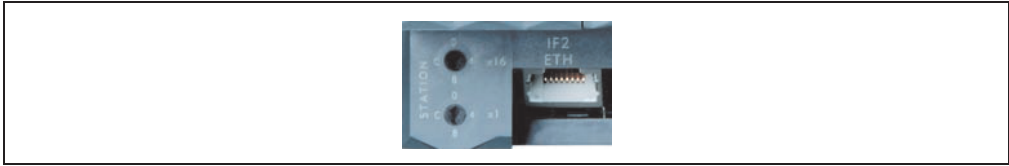

Figure 8: X20 CPUs - Ethernet interface (IF2)

IF2 is an Ethernet interface. The connection is made using a 10/100 BASE-T Twisted Pair RJ45 socket.

The INA2000 station number for the Ethernet interface is set with the two hex switches.

## Information:

The Ethernet interface (IF2) is not suited for ETHERNET Powerlink (see interface IF3 on page 17).

### Pin assignments

Pin	Assignment	
1	RXD	Receive Data
2	RxD\	Receive Data\
3	TxD	Transmit Data
4	Termination	
5	Termination	
6	TxD\	Transmit Data\
7	Termination	
8	Termination	

Table 11: X20 CPUs - pin assignments - Ethernet interface (IF2)



### 1.1.12 ETHERNET Powerlink Interface (IF3)

The station number can be set using software. Station numbers are permitted between \$00 and \$FD.

Switch position	Description
\$00	Operation as Managing Node (standard).
\$01 - \$FD	Station number for Powerlink station. Operation as controlled node.
\$FE	Reserved, switch position is not permitted.
\$FF	Reserved, switch position is not permitted.

Table 12: X20 CPUs - ETHERNET Powerlink station number

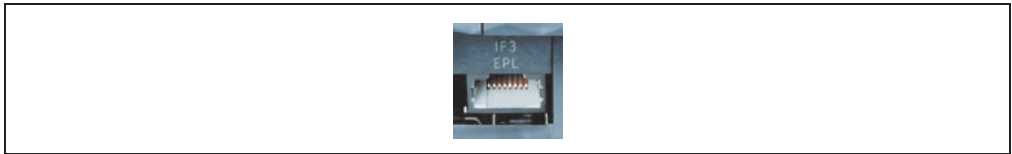

Figure 9: X20 CPUs - ETHERNET Powerlink interface (IF3)

Pin	Assignment	
1	RXD	Receive Data
2	RxD\	Receive Data\
3	TxD	Transmit Data
4	Termination	
5	Termination	
6	TxD\	Transmit Data\
7	Termination	
8	Termination	

Table 13: X20 CPUs - pin assignments - ETHERNET Powerlink interface (IF3)

### 1.1.13 USB interfaces (IF4 and IF5)

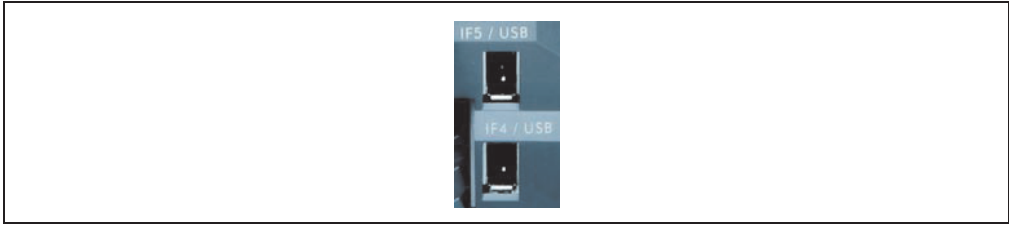

Figure 10: X20 CPUs - USB interfaces (IF4 and IF5)

IF4 and IF5 are USB interfaces. The connection is made using a USB 1.1 interface.

The USB interfaces can only be used for devices which have been released by B&R (e.g. floppy disk drive, DiskOnKey or dongle).

#### **Information:**

**The USB interfaces cannot be used as online communication interfaces.**

### 1.1.14 Slots for interface modules

The CPUs are equipped with one or three slots for interface modules.

The X20 system can be connected to various bus or network systems by selecting the appropriate interface modules.

### 1.1.15 Exchangeable fan

The CPUs do not require a fan. The Celeron 650 CPU can optionally be fitted with a fan. This equips it for unrestricted use over the entire temperature range.

#### Changing the fan

- 1) Press in fan lock with thumb and pull out fan.
- 2) Insert new fan into CPU until the lock clicks into place.

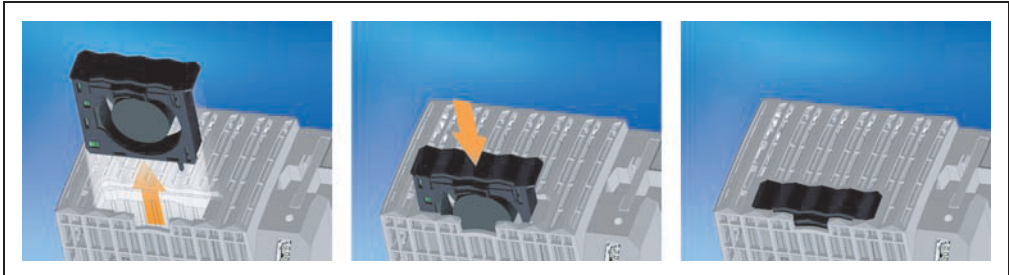

Figure 11: X20 CPUs - tool-free fan replacement

### 1.1.16 Overtemperature shut-off

To prevent damage, a shut-off/reset is triggered when the CPU reaches 100 °C.

The following errors are entered in the log book:

Error number	Error description
9204	WARNING: System halted because of temperature check
9210	WARNING: Boot by watchdog or manual reset

Table 14: X20 CPU log book entries for overtemperature shut-off

### 1.1.17 Data / real-time buffering

The CPUs are equipped with a backup battery. The following areas are buffered:

- Remanent variables
- User RAM
- System RAM
- Real-time clock

### Battery monitoring

The battery voltage is checked cyclically. The cyclic load test of the battery does not considerably shorten the battery life, instead it gives an early warning of weakened buffer capacity.

The status information "Battery OK" is available from the system library function "BatteryInfo" and the CPU's I/O mapping.

### Battery change interval

The battery should be changed every 4 years. The change interval refers to the average life span and operating conditions and is recommended by B&R. It is not the maximum buffer duration.

### 1.1.18 Changing the lithium battery

The CPUs are equipped with a lithium battery. The lithium battery is placed in a separate compartment and protected by a cover.

### Backup battery data

Model number 4A0006.00-000 0AC201.9	1 piece 5 pieces
Short description	Lithium battery, 3 V / 950 mAh, button cell
Storage temperature	-20 to +60 °C
Storage time	Max. 3 years at 30°C
Humidity	0 to 95 % (non-condensing)

Table 15: X20 CPUs - backup battery data

The product design allows the battery to be changed with the PLC switched either on or off. In some countries, safety regulations do not allow batteries to be changed while the module is switched on. To prevent data loss, the battery must be changed within 1 min. with the power off.

## Procedure for changing the battery

- 1) Touch the mounting rail or ground connection (not the power supply!) in order to discharge any electrostatic charge from your body.
- 2) Remove the cover for the lithium battery. To do this, slide the cover down from the CPU.



Figure 12: X20 CPUs - removing the cover for the lithium battery

- 3) Remove the battery from the holder (do not use pliers or uninsulated tweezers -> risk of short circuiting). The battery should not be held by its edges. **Insulated** tweezers may also be used for removing the battery.

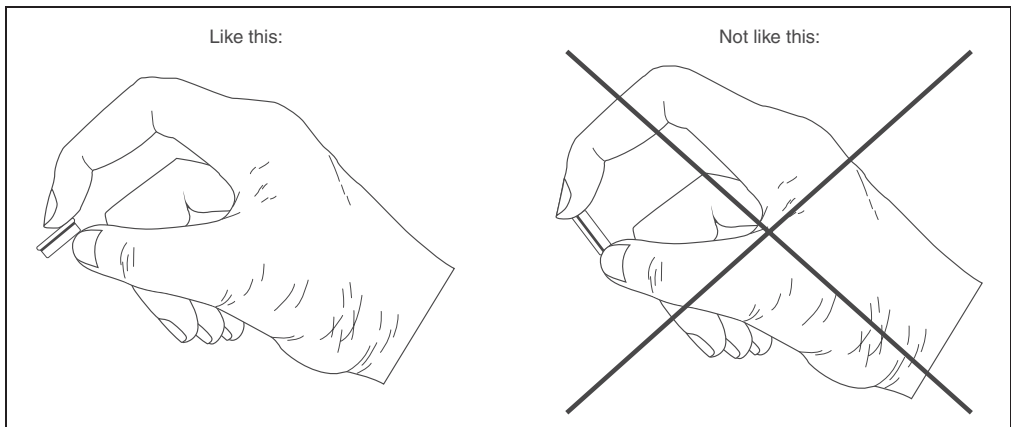

Figure 13: X20 CPUs - correct grip for the battery

- 4) Insert the new battery with correct polarity. To do this, the battery is laid with the "+" side up on the right part of the battery holder under the USB interface IF4. Then secure the battery in the holder by pressing above the left part of the battery holder.
- 5) Replace cover.

## Information:

**Lithium batteries are considered hazardous waste. Used batteries should be disposed of accordingly.**

### 1.1.19 Programming the System Flash

#### General information

The CPUs are delivered with a default B&R Automation Runtime™ (with limited functions) already installed. This runtime system is started in Boot mode (operating mode switch position BOOT, no or invalid CompactFlash inserted). It initializes and operates the serial RS232 onboard interface, allowing a runtime system download via INA2000 protocol.

This runtime system download is carried out during the commissioning of the CPU. The runtime system is stored in the program memory (CompactFlash) of the processor. The runtime system can be updated later by performing a runtime system update or using the B&R Automation Studio PVI Transfer Tool.

X20 System CPUs are supported with B&R Automation Studio™ V 2.5.2.7 or later.

#### Runtime system download

When installing the runtime system (runtime system download) the following procedure must be carried out:

- 1) Insert CompactFlash and switch on the power to the PLC. If the switch is in BOOT position, or if a new or invalid CompactFlash card is inserted, the CPU is now in BOOT mode.
- 2) Establish an online connection between the programming device (PC or Industrial PC) and the CPU. A runtime system download is only possible using the serial RS232 onboard interface.
- 3) Start B&R Automation Studio™ programming environment.
- 4) Start the download procedure by selecting the **Services** command from the **Project** menu. Select **Transfer Operating System...** from the menu shown. Now follow the instructions from B&R Automation Studio™.

- 5) A dialog box is displayed for configuring the runtime system version. The runtime system version is already preselected by the user's project settings. Using the drop-down menu, the runtime system versions stored in the project can be selected. Clicking on the **Browse** button allows the selected runtime system version to be loaded from the hard drive or from the CD.

Pressing **Next** > opens a pop-up window, which allows the user to select whether the modules should be downloaded with SYSTEM ROM target memory using the following runtime system download. Otherwise, modules can also be downloaded using a later application download.

Pressing **Next** > brings the user to a control box where the current settings are displayed.

- 6) The download procedure is started by pressing **Finish**. Download progress is shown in a message window.

## Information:

**The User Flash is cleared.**

- 7) To operate the runtime system, the operating mode switch must be turned to 4 when the download procedure is completed. Reset the CPU or turn off and then on again if necessary.
- 8) The PLC is now ready for use.

### Runtime system update

When updating the runtime system (online runtime system update), the following procedure must be carried out:

- 1) An online runtime system update is only possible if a valid operating system is located on the CompactFlash.
- 2) Establish an online connection between the programming device (PC or Industrial PC) and the CPU. An online runtime update is now possible using the interfaces configured as an online interface.  
The runtime system update can be completed using either a serial online connection (INA2000 protocol), a CAN network, or an ETHERNET network, depending on the system configuration.
- 3) Start B&R Automation Studio™ programming environment.
- 4) Start the update procedure by calling the **Services** command from the **Project** menu. Select **Transfer Operating System...** from the menu shown. Now follow the instructions from B&R Automation Studio™.

- 5) A dialog box is displayed for configuring the runtime system version. The runtime system version is already preselected by the user's project settings. Using the drop-down menu, the runtime system versions stored in the project can be selected. Clicking on the **Browse** button allows the selected runtime system version to be loaded from the hard drive or from the CD.

Pressing **Next** > opens a pop-up window, which allows the user to select whether the modules should be downloaded with SYSTEM ROM target memory using the following runtime system update. Otherwise, modules can also be downloaded using a later application download.

Pressing **Next** > brings the user to a control box where the current settings are displayed.

- 6) The update procedure is started by pressing **Finish**. The update progress is shown in a message box.

## Information:

**The User Flash is cleared.**

- 7) When the update procedure is complete, the online connection is automatically reestablished.
- 8) The PLC is now ready for use.

### Runtime system generation/update with the PVI Transfer Tool

- 1) In the **Tools** menu, select the command **Generate transfer list**.
- 2) In the dialog box that appears, select **Generate complete transfer list** and activate the option **Include operating system**. Continue by clicking on **OK**.
- 3) In the **Tools** menu, select the command **PVI Transfer Tool**. This starts the PVI Transfer Tool. For further steps, please refer to the Help for the PVI Transfer Tool (Tools - Create CompactFlash).