

SIEMENS













SINAMICS S120: The flexible drive system for high- performance motion control applications

Frequency converters

[siemens.com/sinamics-s120](https://www.siemens.com/sinamics-s120)

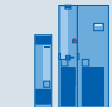
SINAMICS – the optimum drive for every task

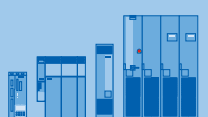
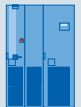
The drive family for drive solutions that are fit for the future

Low voltage						DC	Medium voltage				
AC							AC				
For basic applications		For higher-performance applications				For basic servo applications	For basic and highly complex applications	For applications with high power ratings			
											
SINAMICS G110	SINAMICS G110D	SINAMICS G120P	SINAMICS G120D	SINAMICS G120C	SINAMICS G120	SINAMICS G130/G150	SINAMICS S110	SINAMICS S120	SINAMICS S150	SINAMICS DCM	SINAMICS GL150 / GM150 / SM150 / SL150
V/f control	V/f control/FCC	V/f control/FCC/vector control with and without encoder	V/f control/FCC/vector control with and without encoder			Servo control	V/f control/Vector control/Servo control		Speed control / torque control	V/f control/Vector control	
0.12–3 kW	0.75–7.5 kW	0.37–90 kW	0.75–7.5 kW	0.55–18.5 kW	0.37–250 kW	75–2700 kW	0.12–90 kW	0.12–4500 kW	75–1200 kW	6 kW–30 MW	0.8–120 MW
Pumps, fans, conveyor belts	Conveyor technology	Pumps, fans, compressors	Pumps, fans, conveyor belts, compressors, mixers, crushers, extruders			Single-axis positioning applications in machinery and plant building	Production machines (packaging machines, textile and printing machines, paper machines, plastics machines), machine tools, plants, process lines and rolling mills		Test stands, crosscutters, centrifuges	Rolling mill drives, wire-drawing machines, extruders and kneaders, cable railways and lifts, test stand drives	Pumps, fans, compressors, mixers, extruders, crushers, rolling mill lines, mine hoist drives, excavators, test stands, ship's drives, conveyor belts, blast furnace blowers
Common engineering tools											
SIZER – for simple planning and engineering						STARTER – for fast commissioning, optimization and diagnostics					

The SINAMICS family offers the optimum drive for each and every drive application – and all of the drives can be engineered, parameterized, commissioned and operated in a standard way.

SINAMICS – can tackle any drive application







- Wide range of power ratings from 0.12 kW to 120 MW
- Available in low-voltage and medium-voltage versions
- Standard functionality using a common hardware and software platform
- Standard engineering using just two tools for all drives: SIZER for engineering and STARTER for parameterization and commissioning
- High degree of flexibility and combinability

The SINAMICS S120 drive system

The best perspectives for a productive future

SINAMICS S120 – versions

Modular drive system for sophisticated single-/multi-axis applications

AC/AC drive units for single-axis applications		DC/AC drive units for multi-axis applications			
Blocksize	Chassis	Booksize Compact	Booksize	Chassis	Cabinet Modules
					

High degree of flexibility for successful machine concepts

As a member of the new SINAMICS drive family, the SINAMICS S120® drive is part of the modular drive system for high-performance applications in machinery and plant construction. SINAMICS S120 offers high-performance single- and multi-axis drives for an extremely wide range of industrial applications. Through its scalability and flexibility, SINAMICS S120 perfectly fulfills the growing requirements relating to the number of axes and performance. SINAMICS S120 allows flexible machine concepts to be created, which can be used to quickly implement specific customer requirements.

The answer to complex requirements

Today, machines must be able to be manufactured more cost-effectively and at the same time they should offer operating companies increasingly higher levels of productivity. The SINAMICS S120 drive concept fulfills both of these tasks! Engi-

neering times are shortened due to the fact that it can be engineered in a user-friendly fashion. Its high dynamic performance and accuracy permits higher cyclic machine rates for a maximum degree of productivity. Not only this, its simple handling and maintenance increases the degree of availability and reduces the life cycle costs. When considering everything: SINAMICS S120 increases the competitiveness of both machine manufacturers and operating companies.

Modularity for machine construction

SINAMICS S120 allows power and control performance to be freely combined. Multi-axis drive solutions with higher-level motion control can be implemented using the modular SINAMICS S120 drive system just the same as solutions involving single-motor drives. This means that the machines can be designed to be fully modular therefore addressing the growing number of different versions. Where modules or individual components are to be combined or innovated, SINAMICS S120 guarantees the perfect

compatibility between all of the system components without requiring any major engineering costs.

Applications in machine and plant construction

SINAMICS S120 means increased machine performance in many sectors – whether continuous material webs or cyclic and high-dynamic processes, for instance in:

- Packaging machines
- Plastics machines
- Textile machines
- Printing machines
- Paper machines
- Hoisting gear
- Handling and assembly systems
- Machine tools
- Rolling mills
- Test stands

SINAMICS S120 for high-performance single- and multi-axis applications

The modular system for high-performance applications

The innovative SINAMICS S120 hardware and software concept tackles sophisticated drive tasks in industrial applications with a power range extending from 0.12 through to 4,500 kW:

SINAMICS S120 offers high-performance individual AC/AC drives in the Blocksize and Chassis formats as well as coordinated DC/AC drives for multi-axis applications in the Booksize Compact and Chassis formats and Cabinet Modules.

Increased flexibility with central control intelligence

For SINAMICS S120, the drive intelligence is combined together with the control functions in Control Units (CU), which handle both vector and servo control as well as V/f control. For all drive axes, they also handle the speed and torque control as well as additional intelligent drive functions.

Performance can be freely selected for vector and servo controls

SINAMICS S120 vector control is recommended for drive solutions involving continuous material webs – for instance, wire drawing, foil making and paper machines – as well as for hoisting gear, centrifuges and marine drives with harmonious, rotary motion. Servo control with SINAMICS S120 is used for cyclic processes with precise and fast closed-loop position control using servomotors. For instance, this includes applications in the packaging and printing industries as well as machine tools.

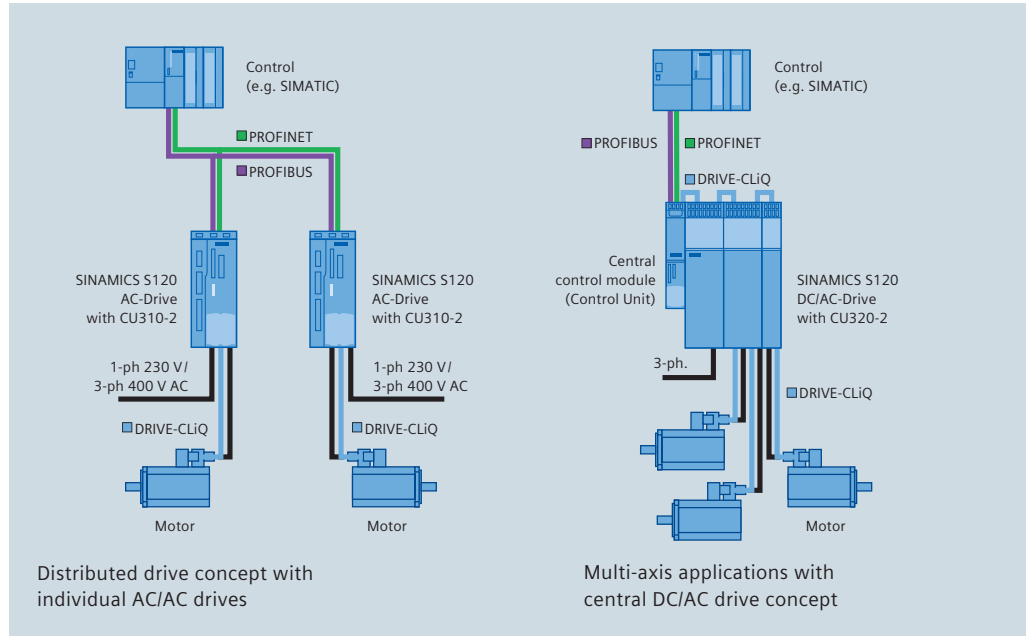

SINAMICS S120 Range of power ratings

- AC/AC single-axis and DC/AC multi-axis drive units
- Power range: 0.12–4,500 kW
- Line supply voltages 230 V, 380–480 V and 660–690 V (50/60 Hz)
- Servo, vector control, V/f control
- Induction and synchronous motors (incl. torque and linear motors)

SINAMICS S120 – functions for increased efficiency

- Basis functions: Speed and torque control, positioning functions
- Intelligent starting functions for automatic restart after a power interruption
- BICO technology with interconnection to drive-related I/Os
- Graphic configuring with free blocks using DCC to adapt the drive system in a user-friendly fashion to the machine environment
- Integrated safety functions to cost-effectively implement safety concepts
- Controlled infeed / regenerative feedback to avoid undesirable harmonics fed back into the line supply, regenerative feedback when braking and for an increased degree of ruggedness with respect to line supply fluctuations

Extremely simple engineering and commissioning



Tool SIZER for Siemens Drives

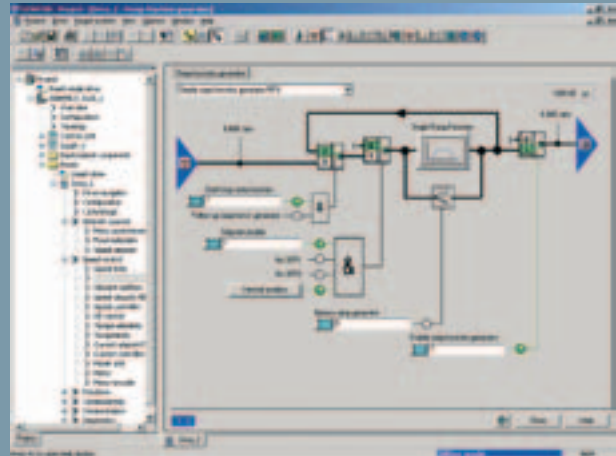

Tool STARTER

Cost-effective with system-based flexibility

The SINAMICS family of drives – that represents a completely new design – addresses the potential to reduce costs – from single-motor drives and drive converters with low power ratings through servo and vector drives up to drives in the highest power range. SINAMICS covers the complete range of power ratings with a unique, unified philosophy and operator navigation! This means simple entry into the system. And once know-how has been established, it can be directly transferred to other applications – for instance, using the tools for engineering, configuring and commissioning, which are applicable across the complete range of SINAMICS drives.

The optimum configuration is quickly and reliably found: SIZER engineering tool

With SINAMICS, a drive system is engineered as quickly and reliably as never before. This is because the SIZER engineering tool includes all of the components that can be used when designing

a drive system and permits users to engineer drives simply and in a focused fashion. SIZER is easy to get to know and can be intuitively handled thanks to its graphic interface and integrated Wizard.

Speeds up commissioning: STARTER tool

STARTER is the standard commissioning tool for all drives belonging to the SINAMICS family. The commissioning engineer can transparently configure and optimize even complex systems in an extremely short time. STARTER is available in three installation versions: As stand-alone version, integrated in Drive ES for applications with SIMATIC or integrated in SCOUT for applications with SIMOTION.

Fast and automatic: electronic rating plate

The electronic rating plates used in every component are an important component when it comes to digitally interlinking the SINAMICS S120 drive system. These electronic rating plates allow all of the drive components to be automatically identified through the DRIVE-CLiQ con-

nection. This means that data does not have to be manually entered while commissioning the system, or when replacing components – commissioning becomes even more reliable! For instance, parameters of the electrical equivalent circuit diagram and the characteristic values of the integrated motor encoder are saved in the electronic motor rating plates. Information such as ordering and identification numbers are also saved.

Made easy: engineering and handling

- All of the drive components can be simply interconnected using pre-fabricated DRIVE-CLiQ cables
- The drive configuration is automatically parameterized using the electronic rating plates
- Drives are quickly and reliably engineered using the SIZER engineering tool
- Drives are commissioned in a user-friendly fashion using the STARTER commissioning tool

SINAMICS S120 – DC/AC Drives for multi-axis applications

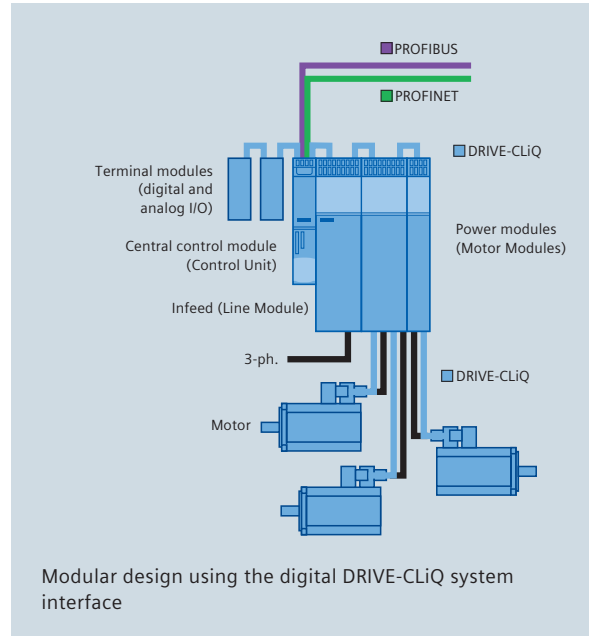

SINAMICS S120 DC/AC drive units for multi-axis applications

The modular drive configuration for multi-axis applications consists of:

- One Control Unit with the complete drive intelligence (including interface to the higher-level controls or HMI devices)
- One Line Module for the central power infeed
- One or several Motor Modules to control the power
- Optional Terminal Modules to connect encoders and drive-related I/Os
- Simple, straightforward cabling using DRIVE-CLiQ
- All interfaces communicate through pre-fabricated cables
- Drive components are detected using electronic rating plates
- Motor Modules and Line Modules are available in the Booksize Compact, Booksize and Chassis formats

Flexibility and scalability through modular design

DC/AC drive units distinguish themselves due to their modular design. All of the drive intelligence is provided in the Control Units (CU), which handle all of the control functions in the drive group. Further, they execute all additional drive functions – e.g. logically interlocking drive-related I/Os, positioning functions, etc. – and have either PROFIBUS DP or PROFINET as central interface to couple to higher-level automation systems. SIMOTION D or SINUMERIK 840D sl can be used as special Control Units for motion control and NC applications.

Line Modules centrally feed the energy into the DC link. Line Modules with regulated infeed/regenerative feedback can optionally ensure a constant DC link voltage and a high degree of compatibility with the line supply.

Motor Modules supply motors with power from the DC link. Double-axis modules allow an especially compact design to be achieved. Drive-related inputs/outputs can be expanded in a scalable fashion using Terminal Modules.

An especially compact design allows drive systems to be packaged in the Booksize Compact format. Further, double-axis modules also allow the mounting width of Booksize Compact and Booksize drive units to be further reduced.



Booksize units from 1.6 to 107 kW



Chassis units from 75 to 1,200 kW



Control unit CU320-2

Flexible cooling types

SINAMICS S120 Chassis drive units are available both in air-cooled as well as liquid-cooled versions. The liquid-cooled version is ideal for dusty, salt-laden or aggressive ambient air and represents a cost-saving alternative with low operating costs. It allows hermetically sealed cabinet solutions to be implemented with a footprint that is up to 60% smaller. The Booksize units are either available with internal/external air cooling or with liquid cooling. Drive units with coldplate cooling allow heat to be dissipated through the rear of the units to the mounting surface.

Digital DRIVE-CLiQ interface: For lower wiring costs

Seamless component communications are a prerequisite for a modular, state-of-the-art drive system architecture. As the standard digital interface between all of the SINAMICS S120 drive components, the simple, plug-in DRIVE-CLiQ cable reduces the time required.

The DRIVE-CLiQ system interface:

- Connects all components – including motors and encoders
- Is used to connect drive-related I/Os and the encoder systems integrated in the motor
- Is supplied from a 24 V power supply that is integrated in the encoder cable
- Reduces the variety of parts, storage costs and commissioning time and costs as a result of the standard cable and connector systems used

All of the different versions can be freely combined

The different SINAMICS S120 versions can be combined as required through the DRIVE-CLiQ interface. For instance, Line Modules in the Chassis format can be combined with Motor Modules in the Booksize format to address multi-axis applications with a high total power rating.

SINAMICS S120 – AC Drives for single-axis applications



Blocksize drive units from 0.12 to 90 kW



Chassis unit from 110 to 250 kW

Single-axis drive or SINAMICS S120 AC Drive

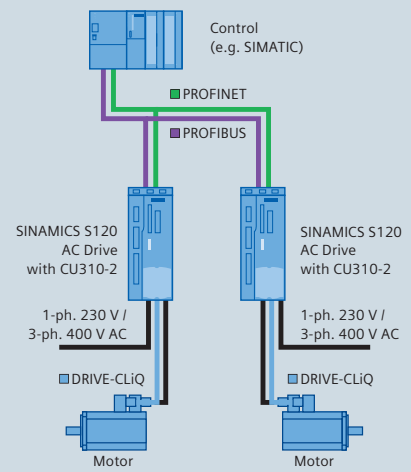

AC Drives for single-axis applications

- An autonomous single-axis SINAMICS S120 AC Drive comprises a Control Unit and Power Module
- Alternatively, a Power Module can be integrated into a multi-axis group via CU adapter
- Power Modules are available in the Blocksize and Chassis formats

Typical applications

Single-axis drives are suitable for applications in all sectors, such as e.g. for travel drives, centrifuges, elevators and extruders as well as for mixers and kneaders.

Single-axis SINAMICS S120 AC Drives are also the ideal solution for multi-axis applications where the drive axes are located remotely from one another. The same applies to modular machine concepts that are being increasingly implemented in the packaging and wood-working industries.

For a single-axis drive, the line supply infeed and the power supply of the motor are combined in one device – the so-called Power Module. For single-axis applications, a special Control Unit (e.g. CU310-2) mounted on the Power Module handles the drive control; for multi-axis

applications a Control Unit is used (e.g. CU320-2) coupled through DRIVE-CLiQ. In the latter case, instead of the Control Unit, a CU adapter is mounted on the Power Module.

For instance, SINAMICS S120 AC Drives decentrally coupled to a higher-level control via PROFIBUS DP or PROFINET can reliably handle e.g. positioning tasks in automated assembly machines and handling systems.

SINAMICS S120 composite group with DRIVE-CLiQ adapter

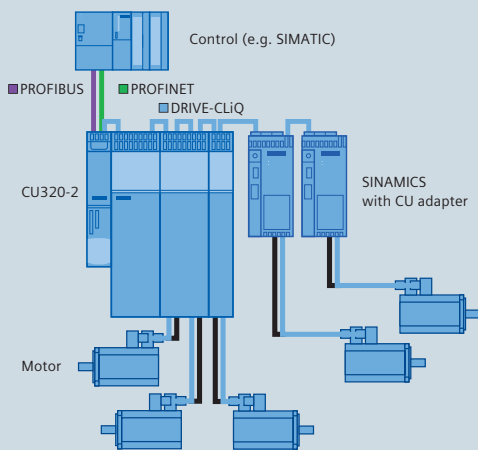

Control Unit
CU310-2

Control Unit
SIMOTION D410

Adapter
CUA31

Adapter
CUA32

Central control intelligence with interface to the control: Control Unit CU310-2

The AC Drives have a CU310-2 Control Unit to couple them to the higher-level control. They offer a functional scope extending from a basic speed controller up to extensive positioning functions.

Either a CU310-2 DP with PROFIBUS DP port or CU310-2 PN with integrated PROFINET port can be selected. Drive-related inputs/outputs can be simply connected to the CU using BICO technology. This permits the highest possible decoupling between the drive and the higher-level control.

Also for the AC drives, when necessary, an additional encoder and drive-related I/Os can be connected through DRIVE-CLiQ.

Motion control integrated in the drive: SIMOTION D410 Control Unit

The SIMOTION D410 Control Unit is the ideal solution if, going beyond the pure control intelligence, motion control is required for an axis and PLC functionality in a compact package. SIMOTION D410 can be used for single-axis applications – such as winders, crosscutters or feed equipment – but also in synchronous groups for modular machine concepts. In this case, the machine module, automated using SIMOTION D410, receives the leading value from a higher-level control and synchronizes its axis to this leading value.

Either the D410 DP with PROFIBUS DP connection or D410 PN with integrated PROFINET port can be used.

Up to four fast cam outputs or three measuring probe inputs can be implemented using the onboard inputs/outputs.

CUA31/32 Control Unit Adapter for multi-axis applications with SINAMICS S120 AC Drive

The drive is coupled to e.g. a CU320-2 multi-axis Control Unit through the CU Adapter CUA31 via a DRIVE-CLiQ interface. In this collection, SINAMICS S120 AC Drives can also be used together with SINAMICS S120 multi-axis drive units. This collection provides the highest degree of flexibility when using SINAMICS S120 Drives.

When compared to the CUA31, the CUA32 additionally has an HTL/TTL encoder interface to connect up an external encoder.

For even more safety – integrated functions for SINAMICS S120

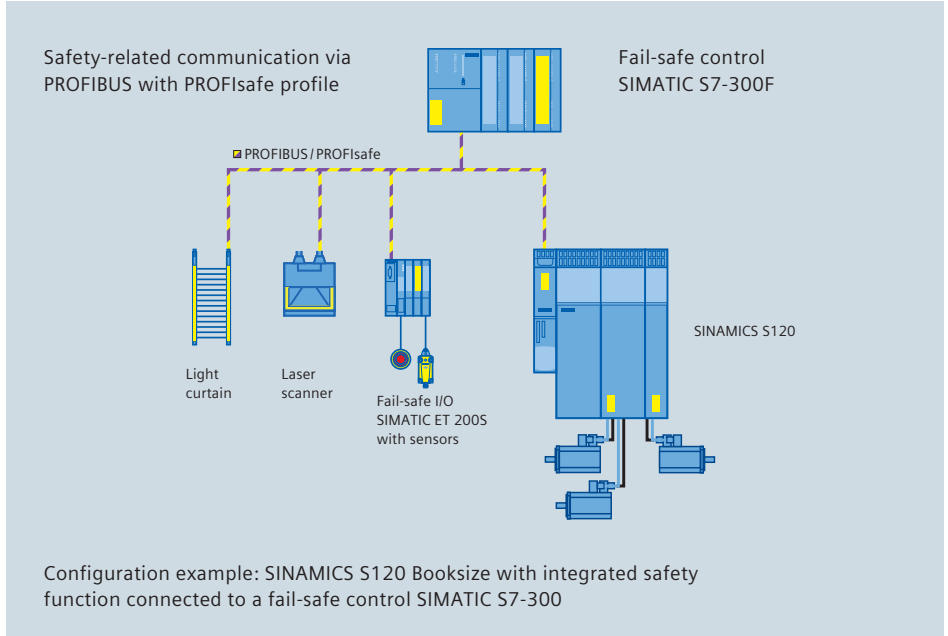
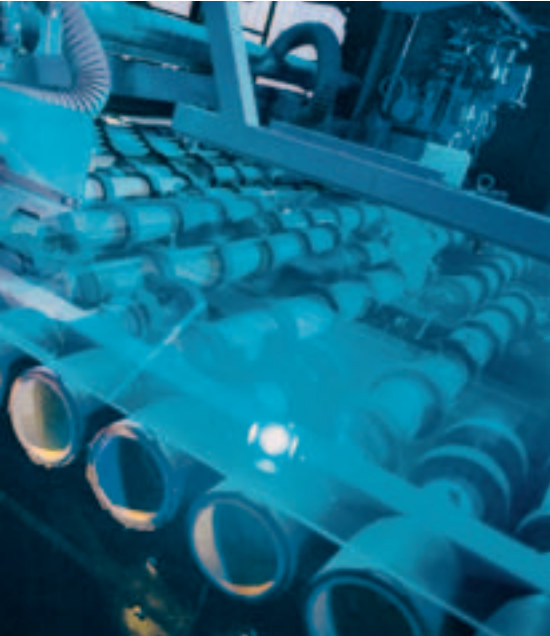

Lower costs and higher availability

The safety functions integrated in SINAMICS S120 offer users clear advantages: As a result of their integration, they reduce the amount of space required and lower the wiring costs. The degree of availability increases through optimized process sequences and simple machine structures as well as machine operator concepts in line with those required in practice. SINAMICS safety solutions are certified according to EN 954-1 Cat. 3, IEC 61508 SIL 2, as well as ISO 13849-1, PL d.

Safety Integrated functions to simply implement safety concepts

SINAMICS S120 drive systems have extensive safety functions. They allow innovative safety concepts to be simply realized in conformance with the appropriate

standards. "Safe Torque Off", "Safe Stop 1" and "Safe Brake Control" are included onboard as basic safety functions. When selected, e.g. in a dangerous situation, all three functions disconnect the energy feed to the motor in a safety-relevant fashion.

The extended safety functions

"Safe Operating Stop", "Safe Stop 2", "Safely-Limited Speed", "Safe Direction", "Safely-Limited Position" and "Safe Speed Monitor" allow the drive to be reliably monitored in operation or when temporary, exceptional situations occur, for instance when equipping machines or carrying out maintenance work. As the position controller normally remains active in normal operation, once the exceptional situation no longer exists, the drive axis can immediately resume normal operation. It is easy and safe to perform maintenance work, which significantly reduces plant or machine downtimes.

The safety functions can either be controlled via safety input terminals, either on board the Control Unit or at the TM54F Terminal Module. Control is possible via PROFIBUS and PROFINET with PROFI-safe when the drive is integrated in a complete automation solution.

Integrated intelligence

SINAMICS S120 can do even more – beyond just classic drive control – as they also have:

- EPos – integrated functions for positioning tasks
- Safety Integrated – integrated safety functions to simply implement safety concepts
- Drive Control Chart (DCC) – freely programmable, drive-related open and closed-loop control and arithmetic functions

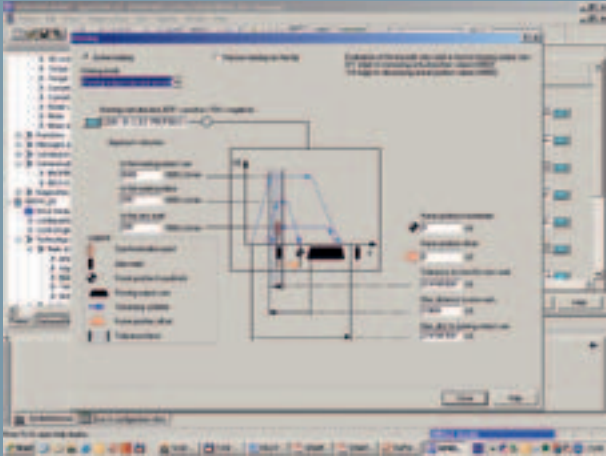

Parameterizing mask for EPos

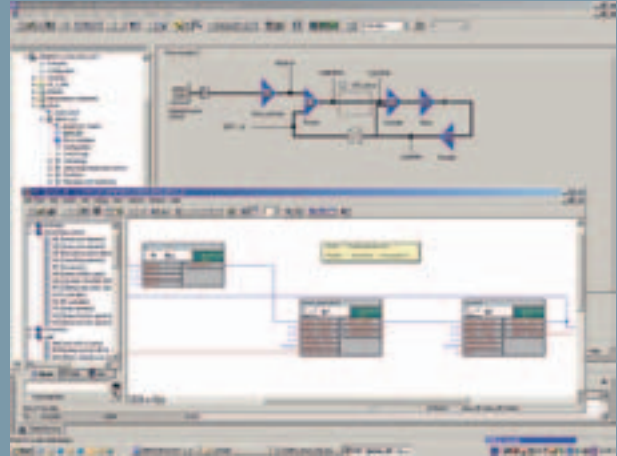

Graphic configuring with DCC

EPos – positioning functions integrated in the drive

With the integrated EPos positioning functions, for many positioning applications, an additional, higher-level positioning control is just not required. And not only this, but this integrated functionality is also extremely flexible: It functions for high-dynamic servo controls just the same as for more basic applications with vector-controlled induction motors. Up to 64 absolute target positions or traversing distances as well as the traversing velocities can be permanently saved in the drive when it is being commissioned. Beyond this, it is also possible to transfer these parameters as required from a higher-level PLC. It is even possible to change target positions and velocities on-the-fly while the drive is actually positioning.

Commissioning is simple and transparent thanks to the pre-configured parameterizing forms in the SINAMICS STARTER commissioning tool.

DCC – Drive Control Charts: To optimally adapt to the drive task

Using Drive Control Charts, the SINAMICS S120 drive system can do more than just handle the classic drive control. Drive Control Charts (DCC) also permit drive-related open-loop and closed-loop control tasks to be shifted into the drive. This means that the drive system can be flexibly and optimally adapted to a whole raft of drive and automation scenarios.

DCC – an overview of the advantages

- Higher-level controls are relieved, machine sequences can be simply implemented at lower costs and local processing in the drive increases the overall machine performance. As a whole, the implementation of modular machine concepts is further simplified.
- To define the open-loop and closed-loop control functions, a user-friendly DCC Editor is used to select blocks from a predefined library. These are then graphically interconnected with one another by dragging and dropping them. The program behavior can be verified using test and diagnostic functions – or in the case of an error, the cause can be identified.
- User-friendly graphic programming with DCC Editor

Totally Integrated Automation – setting standards in productivity

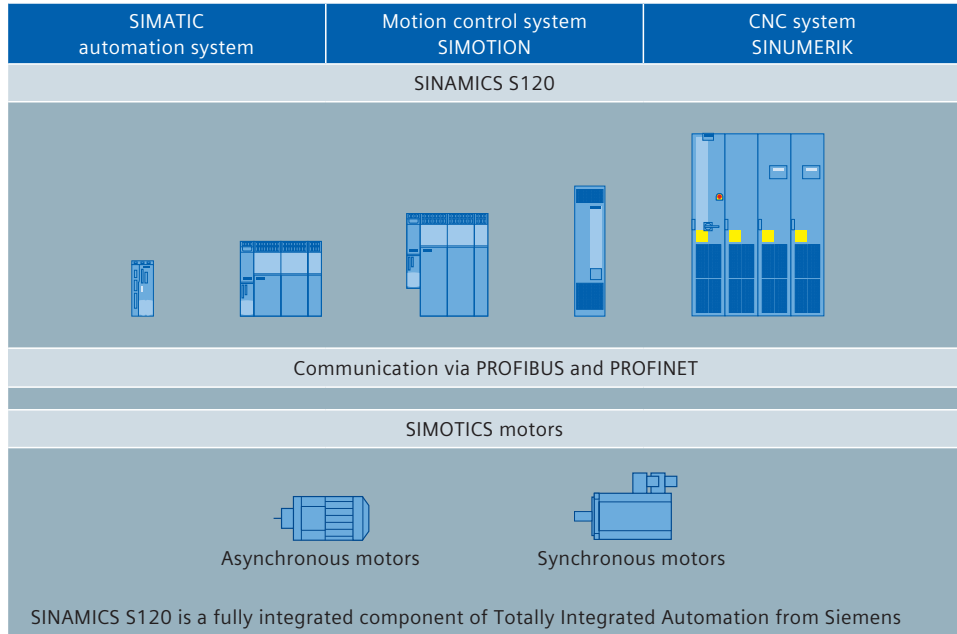

Totally Integrated Automation with SINAMICS S120

- TIA: Unified, sector-specific automation solutions
- PROFIBUS and PROFINET are integral components of TIA
- Motion control with SIMOTION
- Numerical control with SINUMERIK

The basis for customized automation solutions

With its Totally Integrated Automation (TIA), Siemens is the only manufacturer that offers a seamless range of products and systems for all industry sectors – from a single source. Harmonized to the individual customer requirements, based on TIA, efficient industry sector-specific automation solutions can be implemented. Lower life cycle costs when operating machines and systems and considerably shorter times to market result in significant increases in productivity and a higher investment security.

Straightforward: Totally Integrated Automation with SINAMICS S120

In addition to SIMATIC, SIMOTION and SINUMERIK, SINAMICS also belongs to the core components of Totally Integrated Automation. For instance, the STARTER commissioning tool is an integral component of TIA. All of the automation solution components can be parameterized, programmed and commissioned using a unified engineering platform within the same environment. The integrated data management ensures consistent data and simple archiving of the complete plant or machine project.

Communications without limits



PROFIBUS: No. 1 in field buses

SINAMICS S120 supports, as standard, PROFIBUS DP – the standard field bus within Totally Integrated Automation. It ensures powerful and seamless communications between all of the components involved in the automation solution: HMI (operator control and visualization), control, drives and I/O.

PROFINET: for increased performance and open IT communications

SINAMICS S120 is also available with a PROFINET interface. This Ethernet-based bus allows control data to be quickly exchanged and means that SINAMICS S120 drives can even be used in the highest-performance multi-axis applications. PROFINET simultaneously transmits, for example, operating and diagnostics data to higher-level systems using standard IT mechanisms (TCP/IP). This means that it can be simply integrated into an IT factory environment.

PROFIdrive – drive interface for PROFINET

For PROFINET and PROFIBUS, the functional interface between the control and the drives is defined by the PROFIdrive drive profile V4 from PROFIBUS International (PI). PROFIdrive is specified by the PI User Organization and is established through Standard IEC 61800-7 as the standard that is fit for the future.

PROFINET users who are already operating drives connected to PROFIBUS profit from this.

A user program does not have to be changed when making a transition from PROFIBUS to PROFINET.

PROFIdrive defines the device behavior and the way internal device data is accessed for electric drives connected to PROFIBUS and PROFINET – from basic drive converters up to high-performance servo controllers.

Total solutions in machinery construction – SINAMICS S120 as the perfect basis

SIMOTICS motors for Motion Control

Servo	Main	Linear	Torque
S	M	L	T
			

The drive solution that offers everything

The broad range of functionality and the different versions mean that SINAMICS S120 represents a universal drive solution for the machinery construction sector. A wide range of motors and control systems that are optimally tailored to the various applications permit fully integrated solutions – simple to design, user-friendly when it comes to commissioning and straightforward in operation.

Prefabricated Motion Connect power and data cables allow connections between the motors and power units to be quickly established. Electronic type plates in the motors guarantee reliable autotuning of the drive group. In operation, encoder values are efficiently transferred to the drive group via the DRIVE-CLiQ interface.

The coupling to the automation system is established through PROFIBUS DP, PROFINET or CANopen field buses.

Operating synchronous and induction motors

Synchronous as well as induction motors can be connected to SINAMICS S120. In addition to its range of standard motors, Siemens has a wide range of different motor types – specifically for motion control applications:

- Synchronous servomotors – optionally with various gear types for positioning tasks with the highest dynamic performance, cyclic axes and feed drives
- Induction servomotors for high-speed, precision rotary axes – e.g. for winding applications and those requiring synchronous operation – as well as for main spindles used in machine tools
- Linear motors for positioning and feed axes with the highest dynamic performance
- Torque and Chassis motors for precise, powerful rotary axes – from low up to high speeds



SIMOTION D410-2 PN for single-axis drives SIMOTION D445-2 for multi-axis applications



SINUMERIK 840D solution line



SINAMICS S120 and SIMOTION – the perfect team for production machines

Increasingly, complex motion control tasks must be handled in machinery construction and at the same time, they must be able to run even more precisely and faster. This is where the SIMOTION motion control system and the high-performance SINAMICS S120 drive system form a perfect team. SIMOTION D, the version that is physically integrated into the SINAMICS S120 drive, is the ideal solution for machines with a high number of axes and where high requirements are placed on the precision. This distributed automation structure allows the machine to be subdivided into various axis groups that are controlled from one SIMOTION motion control system. Communications between SIMOTION systems is either established via PROFIBUS DP or PROFINET. In this case, there is another important aspect – the compact machine design, which is due to the distributed automation structure and the Motion Control Unit that is directly integrated in the drive.

SINAMICS S120 and SINUMERIK solution line – the innovative solution for processing machines

SINUMERIK solution line and SINAMICS S120 form the ideal system platform for the machine tool construction sector. Thanks to the scalable hardware and software, SINUMERIK solution line opens up almost limitless application opportunities. Whether for basic turning or milling applications, highly complex tasks and high-speed applications, in woodworking and glass processing or when handling transfer lines – SINUMERIK solution line is the perfect solution for the widest range of requirements in processing machines.

Its essential features include the distributed, simplified system architecture and the expanded diagnostic capabilities down to the component level. SINUMERIK solution line is completely integrated into the SINAMICS communications structure.

SINAMICS S120 – the ideal basis for sophisticated drive tasks in machinery construction:

- Solutions for positioning tasks and simple drive-related closed-loop control functions with integrated EPos and DCC functions
- Solutions for motion control applications with SIMOTION or SIMATIC T-CPU
- Solutions for processing machines using SINUMERIK solution line

Plant construction with SINAMICS S120 – modular and fit for the future



Chassis units from 75 to 1,200 kW



Cabinet Modules from 1.6 to 4,500 kW

SINAMICS S120 Cabinet Modules: modular cabinet concept for multi-motor drives

A modular cabinet system is available in the form of the SINAMICS S120 Cabinet Modules. These can be used to engineer almost any drive solution for multi-motor drive systems in plant construction. Thanks to the standard interfaces, the modules can be interlinked and combined to quickly configure ready-to-connect drive solutions up to 4,500 kW.

- High degree of flexibility through the finely scalable power and module types as well as an extensive range of options
- Extremely compact drive solution that is ready to be connected
- DC coupling using prefabricated busbar sets
- Data is coupled through DRIVE-CLiQ
- Fast and reliable installation and commissioning
- Short delivery times and lower ordering time and costs

The perfect solution – quickly and reliably

Complete drive groups can be interlinked and assembled using the SINAMICS S120 Cabinet Modules and Chassis units. This is because it is possible to combine module types with freely selectable power ratings as required. Fast and straightforward, due to the standard interfaces that are harmonized with one another. For paper machines, rolling mills, test stands and cranes – that typically require multi-motor applications with high power ratings, both the modular cabinet units as well as also the Chassis units are the ideal solution as part of a modular system. The highly flexible, modular system follows the trend to shift intelligence into the drive, which is achieved using its harmonized, standard interfaces. Planning is simplified and reliability increased thanks to the ready-to-connect cabinet solution with several Cabinet Modules. The chassis design of the SINAMICS S120 is the ideal approach for companies that wish to engineer their own chassis-type solutions.



Low costs for plant integration, engineering and installation

The SINAMICS S120 concept means that drives can be quickly and simply integrated into overall plants and systems, both mechanically and electrically. This reduces the engineering costs – and in turn the associated risks. The drive system can be flexibly adapted to plant-specific requirements through an extensive range of options.

Reliable and line-friendly

SINAMICS S120 also takes into account the trend to line-friendly converters due to the increasing demands of power supply utilities. Its constant regulated DC link voltage essentially decouples the motor voltage from the influence of the line supply voltage. On the other hand, the low-frequency harmonics fed back into the line supply can almost be completely neglected through the optional “Clean Power Filter”. Further, the losses in the low-voltage distribution, line-side transformer and line feeder cables, caused by harmonic currents, are eliminated.

SIMOTICS N-compact motors

By combining SINAMICS S120 with N-compact low-voltage motors, system solutions can be implemented that are precisely tailored to individual requirements. N-compact motors distinguish themselves through their rugged design with gray cast-iron frame and bearing end shields as well as their long service life. The compact design makes it easy to integrate them into plants and reduces the dimensions of the complete unit. The 2- to 8-pole motors are convincing thanks to their high efficiency and availability.

The right moment – torque motors

In addition to N-compact, it is also possible to use 1FW3 torque motors and 1FW4 (HT-direct) motors. State-of-the-art direct drive concepts can be implemented using these motors – and not only that, they make gearboxes superfluous.

Applications in plant construction

- Paper machines
- Rolling mills
- Test stands
- Foil machines
- Man-made textile systems

SINAMICS S120 in plant construction

- Drive versions can be flexibly developed
- Scalable power
- Ready-to-connect Cabinet Modules
- Chassis units for integration into cabinets
- Low costs for training, engineering and commissioning
- Simple to replace, spare parts inventory, logistics
- Low life cycle costs through energy saving and low maintenance costs
- Highest possible security of investment

SINAMICS S120 – technical data

Modules and expansion options: Components for every application

- Control modules (Control Units) handle drive and technological functions spanning axes and provide the central link to higher-level controls
- Motor Modules operate as inverters – supplying the connected motors
- Line Modules centrally feed power into the DC link, regenerate into the line supply and compensate any line fluctuations
- Power Modules for AC Drives combine power infeed and power module in the form of a unit that is ready to be powered up
- Electronic options extend the functionality and cover various interfaces to encoders and process signals
- DC link components are optionally used to stabilize the DC link voltage
- Line-side power components – such as fuses, contactors, reactors, filters – round off the system
- High dynamic performance and precise: 32-bit technology
- Fast: Short current rise times
- Universal: For synchronous and induction motors
- Rugged: High overload factor
- Safe: Safety Integrated
- Flexible and simple: BICO technology
- Plug & Play: DRIVE-CLiQ makes it possible

STO Safe Torque Off
 SBC Safe Brake Control
 SS1 Safe Stop Cat. 1
 SOS Safe Operating Stop
 SS2 Safe Stop Cat. 2
 SLS Safely-Limited Speed
 SSM Safe Speed Monitor
 SDI Safe Direction
 SLP Safely-Limited Position

Drive type
Degree of protection
Line voltage V_{line} /powers
1 AC 200 ... 240 V
3 AC 380 ... 480 V
3 AC 500 ... 690 V
Power infeed
Regenerative feedback
Line frequency
Output voltage
Output frequency
V/f control
Vector control
Servo control
Control principle
V/f control
Vector control with/without encoder
Servo control with/without encoder
Motors
Induction motors
Synchronous motors
Torque motors
Linear motors
Control dynamics
Vector control
• rise time speed control
• rise time M control
Servo control
• rise time, speed control
• rise time, torque control
Technological functions
Safety functions
Interfaces
Tools
Typical applications / application technologies
Catalog

S120 – Modular drive system for sophisticated single-/multi-axis applications

Blocksize	Chassis	Booksize Compact	Booksize	Chassis	Cabinet Modules
					
AC/AC unit modular	AC/AC unit modular	DC/AC system modular	DC/AC system modular	DC/AC system modular	DC/AC system modular
IP20	IP20	IP20	IP20	IP00 / IP20	IP20 (IP21 / IP23 / IP54)
0.12 ... 0.75 kW (0.16 ... 1 HP ³)	–	–	–	–	–
0.37 ... 90 kW (0.5 ... 120 HP ³)	110 ... 250 kW (150 ... 340 HP ³)	0.9 ... 9.7 kW (1.2 ... 13.2 HP ³)	1.6 ... 107 kW (2 ... 145 HP ³)	110 ... 800 kW (150 ... 1,000 HP ³)	1.6 ... 3,000 kW
–	–	–	–	75 ... 1,200 kW (100 ... 1,600 HP ³)	75 ... 4,500 kW
Non-regulated	Non-regulated	Non-regulated	Optional, non-regulated or regulated		
No	No	Yes	Yes, for regulated infeed		
47 ... 63 Hz	47 ... 63 Hz	47 ... 63 Hz	47 ... 63 Hz	47 ... 63 Hz	47 ... 63 Hz
0 ... V _{Line}	0 ... V _{Line}	0 ... V _{Line}	0 ... V _{Line}	0 ... V _{Line}	0 ... V _{Line}
0 ... 400 Hz ¹	0 ... 200 Hz ¹	0 ... 400 Hz ¹	0 ... 400 Hz ¹	0 ... 200 Hz ¹	0 ... 200 Hz ¹
0 ... 300 Hz ¹	0 ... 160 Hz ¹	0 ... 300 Hz ¹	0 ... 300 Hz ¹	0 ... 160 Hz ¹	0 ... 160 Hz ¹
0 ... 650 Hz ¹	0 ... 650 Hz ¹	0 ... 650 Hz ¹	0 ... 650 Hz ¹	0 ... 650 Hz ¹	0 ... 650 Hz ¹
Yes	Yes	Yes	Yes	Yes	Yes
Yes	Yes	Yes	Yes	Yes	Yes
Yes	Yes	Yes	Yes	Yes	Yes
Yes	Yes	Yes	Yes	Yes	Yes
Yes	Yes	Yes	Yes	Yes	Yes
Yes	Yes	Yes	Yes	Yes	Yes
8 ... 10 ms ¹	11 ... 15 ms ¹	8 ... 10 ms ¹	8 ... 10 ms ¹	11 ... 15 ms ¹	11 ... 15 ms ¹
1 ... 2 ms ¹	2 ... 3 ms ¹	1 ... 2 ms ¹	1 ... 2 ms ¹	2 ... 3 ms ¹	2 ... 3 ms ¹
2 ... 3 ms ¹	5 ... 7 ms ¹	2 ... 3 ms ¹	2 ... 3 ms ¹	5 ... 7 ms ¹	5 ... 7 ms ¹
0.5 ... 1 ms ¹	1 ... 2 ms ¹	0.5 ... 1 ms ¹	0.5 ... 1 ms ¹	1 ... 2 ms ¹	1 ... 2 ms ¹
Flying restart, automatic restart, kinetic buffering, basic positioning, BICO technology, freely configurable blocks (Drive Control Chart), technology controller, motion control (in combination with SIMOTION), numeric control with SINUMERIK solution line					
STO, SBC, SS1, SOS, SS2, SLS, SDI, SLP, SSM					
Digital, analog, serial (RS 232 / RS 485), PROFIBUS DP, PROFINET, CANopen (in conjunction with CU320-2)					
SIZER for engineering, STARTER for commissioning					
High-performance single-motor drives			High-performance multi-motor drives		
Continuous motion control and positioning tasks in production machines, e.g. packaging, textile, printing, paper, plastics machines, plants and processing lines, metal forming; converting applications; numerical control applications in machine tools					
PM21, D31	PM21	PM21	PM21	PM21	D21.3

¹ Blocksize units, Booksize units: with 4 kHz pulse frequency; Chassis units, Cabinet Modules: with 2 kHz pulse frequency

Additional information on SINAMICS is provided under:

www.siemens.com/simotics

www.siemens.com/sinumerik

www.siemens.com/simotion

The addresses and contact partners are provided under:

www.siemens.com/automation/partner

Visit our A&D Mall to place your electronic order directly via Internet:

www.siemens.com/automation/mall

Siemens AG
Industry Sector
Motion Control Systems
P.O. Box 31 80
91050 ERLANGEN
GERMANY

Subject to change without prior notice 04/12
Order No.: E20001-A30-P670-V4-7600
DISPO 21500
WÜ/40847 GD.MC.GM.SIPR.52.2.10 WS 04124.0
Printed in Germany
© Siemens AG 2012

The information provided in this brochure contains merely general descriptions or characteristics of performance which in case of actual use do not always apply as described or which may change as a result of further development of the products. An obligation to provide the respective characteristics shall only exist if expressly agreed in the terms of contract.

All product designations may be trademarks or product names of Siemens AG or supplier companies whose use by third parties for their own purposes could violate the rights of the owners.

www.siemens.com/sinamics-s120