

ABB INDUSTRIAL DRIVES

CIO-01 I/O module for distributed I/O bus control

User's manual



List of related manuals

General manuals

Safety instructions for ACS880 liquid-cooled multidrive cabinets and modules 3AXD50000048633

Electrical planning instructions for ACS880 liquid-cooled multidrive cabinets and modules 3AXD50000048634

Firmware manuals and user's manuals

ACS880 diode supply control program firmware manual 3AUA0000103295

ACS880 IGBT supply control program firmware manual 3AUA0000131562

CIO-01 I/O module for distributed I/O bus control user's manual 3AXD50000126880

Option manuals and guides

ACX-AP-x assistant control panels user's manual 3AUA0000085685

Drive composer start-up and maintenance PC tool user's manual 3AUA0000094606

Manuals and quick guides for I/O extension modules, fieldbus adapters, etc.

You can find manuals and other product documents in PDF format on the Internet. See section Document library on the Internet on the inside of the back cover. For manuals not available in the Document library, contact your local ABB representative.

CIO-01 I/O module for distributed I/O bus control

User's manual





Table of contents	
1. Safety instructions	
4. Mechanical installation	
5. Electrical installation	
6. Start-up	

Table of contents

1. Safety instructions

Contents of this chapter	9
Use of warnings	9
General	10
Safety in installation	10
Safety during operation	10

2. Introduction to the manual

Contents of this chapter	11
Applicability	11
Target audience	11
Related documents	11
Terms and abbreviations	12
Cybersecurity disclaimer	12

3. Hardware description and operation principle

Contents of this chapter	13
Product overview	14
Layout drawing of CIO-01 I/O module	14
Push buttons	14
7-segment displays	15
CIO-01 module controlling distributed I/O bus	15
Fan control	16

4. Mechanical installation

Contents of this chapter	19
Necessary tools and instructions	19
Unpacking and examining the delivery	19
Installing the module	20
Grounding the module	20

5. Electrical installation

Contents of this chapter	21
Warnings	21
Necessary tools and instructions	21
Terminal designations	22
General cabling instructions	22
Wiring	23
Wiring example	23

6. Start-up

Contents of this chapter	25
--------------------------------	----



Start-up procedure	26
Safety	26
Hardware settings	26
Parameter settings	26

7. Program features

Contents of this chapter	27
Overview	27
Basic configuration of the distributed I/O bus	28
Settings	28
Service request parameters	28
Settings	28
Diagnostic counters	28
Settings	28
Identification run of the fans	28
Settings	28

8. Parameters

Contents of this chapter	29
Terms and abbreviations	29
Summary of parameter groups	30
Parameter listing	31
206 I/O bus configuration	31
207 I/O bus service	37
208 I/O bus diagnostics	38
209 I/O bus fan identification	39

9. Additional parameter data

Contents of this chapter	43
Terms and abbreviations	43
Fieldbus addresses	44
Parameter groups 206...209	45

10. Fault tracing

Contents of this chapter	49
Safety	49
Warning and fault indications	49
Warning messages	50
Fault messages	51
LEDs of the CIO-01 module	51

11. Technical data

Contents of this chapter	53
Dimension drawing	54
Isolation areas	55
Specifications	56
Ambient conditions	56
Protection class	56
Materials	56



Applicable standards 56

Further information

Product and service inquiries 57
Product training 57
Providing feedback on ABB Drives manuals 57
Document library on the Internet 57





1

Safety instructions



Contents of this chapter

The chapter contains the warning symbols used in this manual and the safety instructions which you must obey when you install or connect an optional module to a drive, converter or inverter. If you ignore the safety instructions, injury, death or damage can occur. Read this chapter before you start the installation.

Use of warnings

Warnings tell you about conditions which can cause injury or death, or damage to the equipment. They also tell you how to prevent the danger. The manual uses these warning symbols:



Electricity warning tells you about hazards from electricity which can cause injury or death, or damage to the equipment.



General warning tells you about conditions, other than those caused by electricity, which can cause injury or death, or damage to the equipment.

General

Follow all safety instructions delivered with the drive before you install, commission, or use the drive. For single drives, the complete safety instructions are given at the beginning of the hardware manual. For multidrive safety instructions, see *Safety instructions for ACS880 multidrive cabinets and modules* (3AUA0000102301 [English]) for air-cooled modules, and *Safety instructions for ACS880 liquid-cooled multidrive cabinets and modules* (3AXD50000048633 [English]) for liquid-cooled modules.

Read the software function specific warnings and notes before changing the default settings of the function. For each function, the warnings and notes are given in the subsection the function or the related user-adjustable parameters.

Safety in installation

These instructions are for all who install or connect an optional module to a drive, converter or inverter and need to open its front cover or door to do the work.



WARNING! Obey these instructions. If you ignore them, injury or death, or damage to the equipment can occur.

- If you are not a qualified electrician, do not do installation or maintenance work.
- Disconnect the drive, converter or inverter from all possible power sources. After you have disconnected the drive, converter or inverter, always wait for 5 minutes to let the intermediate circuit capacitors discharge before you continue.
- Disconnect all dangerous voltages connected to other control signal connectors in reach. For example, it is possible that 230 V AC is connected from outside to a relay output or digital input of the drive, converter or inverter.
- Always use a multimeter to make sure that there are no parts under voltage in reach. The impedance of the multimeter must be at least 1 Mohm.

Safety during operation



WARNING! If the drive trips due to fan speed under limit (parameter [206.07](#)), the PWM signal for controlling the fan will remain at nominal reference speed, which may lead to a restart of the fan even though the drive remains tripped.



Introduction to the manual

Contents of this chapter

This chapter contains information on the applicability and intended audience.

Applicability

This document is applicable to the CIO-01 I/O module and ACS880 distributed I/O bus. It contains hardware and firmware information specific to them. For other information on the drive, see the drive hardware or firmware manual.

Target audience

This manual is intended for people who design, commission, or operate the drive system.

Related documents

A list of related manuals is printed on the inside of the front cover.

Terms and abbreviations

Term/abbreviation	Definition
AI	Analog input; interface for analog input signals
BCU	Type of a control unit used in ACS880 drives that consists of a BCON board built into a metal housing.
CIO	I/O module for controlling cabinet fans
DDCS	Distributed drives communication system; a protocol used in optical fiber communication
DI	Digital input; interface for digital input signals
DIO	Digital input/output; interface that can be used as a digital input or output
DO	Digital output; interface for digital output signals
Diode supply unit	Diode supply modules under control of one control board, and related components.
IGBT supply unit	IGBT supply modules under control of one control board, and related components.
I/O	Input/Output
NTC	Negative temperature coefficient
Parameter	User-adjustable operation instruction to the supply unit, or signal measured or calculated by the supply unit
PWM	Pulse-width modulation
RS-485	A standard by ANSI (Telecommunications Industry Association/Electronic Industries Alliance, TIA/EIA) defining the electrical characteristics of drivers and receivers for use in balanced digital multipoint systems. Also known as TIA/EIA-485 or EIA-485. RS-485 type interface is used in communication link of the distributed I/O bus.
ZCU	Type of control unit used in ACS880 drives that consists of a ZCON board built into a plastic housing. ZCU control unit is used with eg. liquid cooling unit.

Cybersecurity disclaimer

This product is designed to be connected to and to communicate information and data via a network interface. It is Customer's sole responsibility to provide and continuously ensure a secure connection between the product and Customer network or any other network (as the case may be). Customer shall establish and maintain any appropriate measures (such as but not limited to the installation of firewalls, application of authentication measures, encryption of data, installation of anti-virus programs, etc) to protect the product, the network, its system and the interface against any kind of security breaches, unauthorized access, interference, intrusion, leakage and/or theft of data or information. ABB and its affiliates are not liable for damages and/or losses related to such security breaches, any unauthorized access, interference, intrusion, leakage and/or theft of data or information.

See also *ACS880 diode supply control program firmware manual* (3AUA0000103295 [English]), and *ACS880 IGBT supply control program firmware manual* (3AUA0000131562 [English]).



3

Hardware description and operation principle

Contents of this chapter

This chapter describes the CIO-01 I/O module and ACS880 distributed I/O bus.

Product overview

Layout drawing of CIO-01 I/O module

The following figure shows the layout of the CIO-01 I/O module.

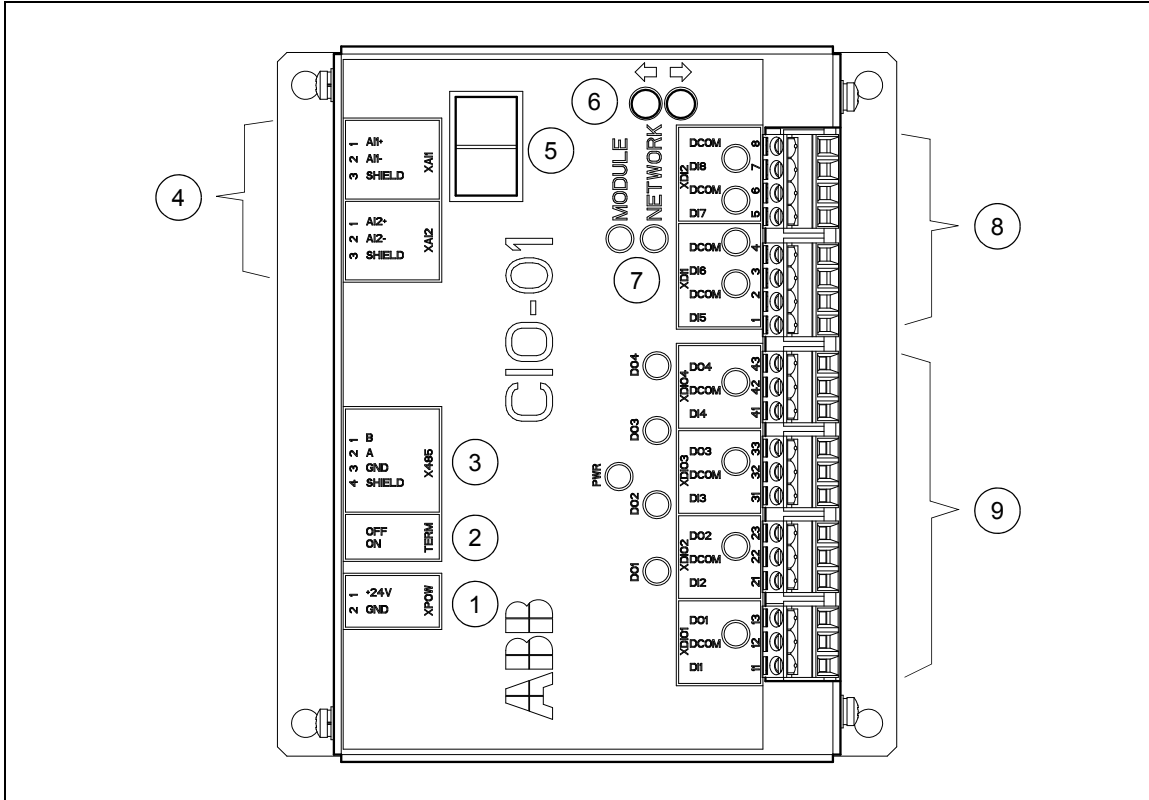

No.	Description
1.	Power supply XPOW
2.	Termination resistor switch
3.	RS-485 communication link
4.	Analog inputs XAI1, XAI2
5.	<i>7-segment displays</i>
6.	<i>Push buttons</i>
7.	<i>LEDs of the CIO-01 module</i>
8.	Digital inputs XDI1, XDI2
9.	Digital inputs/outputs XDIO1...XDIO4

Push buttons

Push button	Description
S1	Node number decreases
S2	Node number increases

■ 7-segment displays

Two 7-segment displays on the CIO-01 module show the node number (1...99). Blinking node value indicates that the configuration change is pending. Solid node value indicates that the node ID configuration value has been acknowledged by the CIO-01 module.

CIO-01 module controlling distributed I/O bus

Distributed I/O bus is controlled by CIO-01 I/O module. Typically, each cubicle that contains cabinet fan, also contains one CIO-01 I/O module:

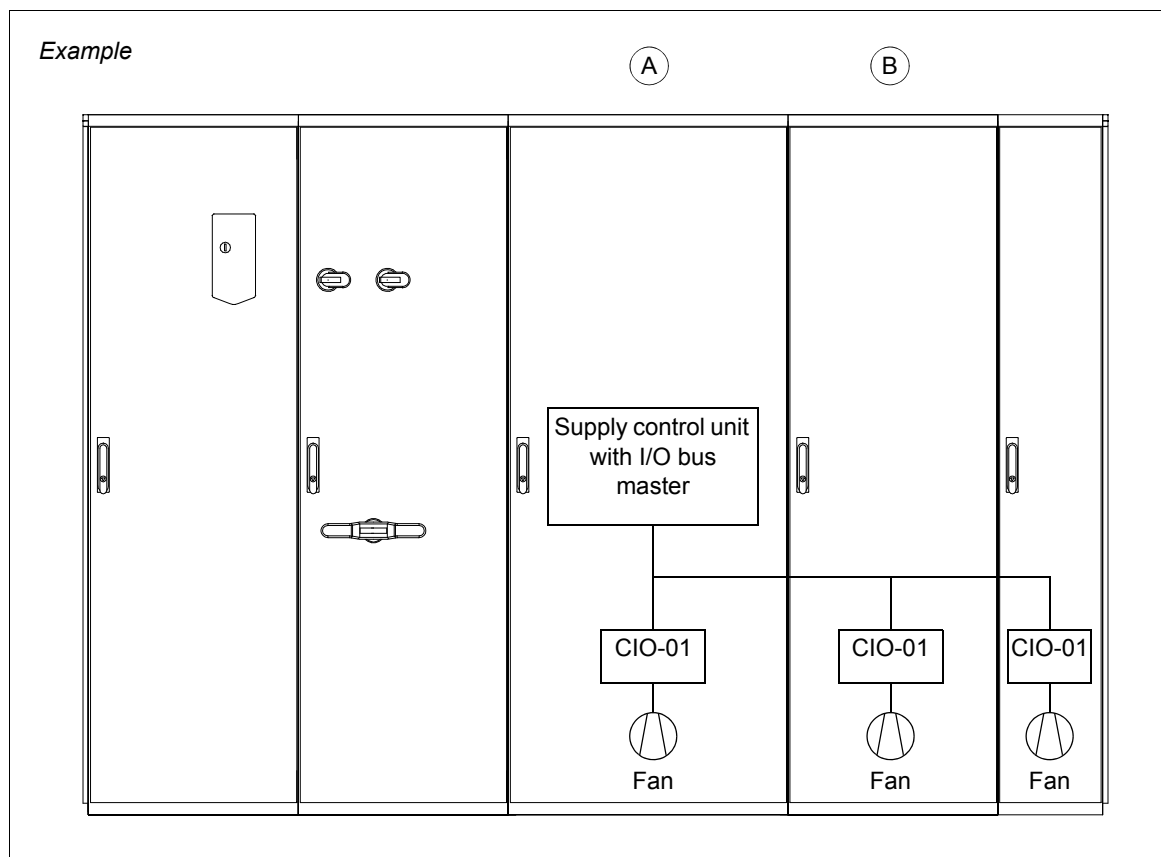

	Description
A	Supply module cubicle
B	Inverter module cubicle

One CIO-01 I/O module contains connectors for four fans (speed reference output and feedback of the fans), two analog inputs, and four digital inputs. You can physically connect 32 CIO-01 I/O modules to the distributed I/O bus in maximum, and only activate 16 of them at maximum from the I/O bus master.

Fan control

The following diagrams describe how the cabinet fan is controlled by the CIO-01 module.

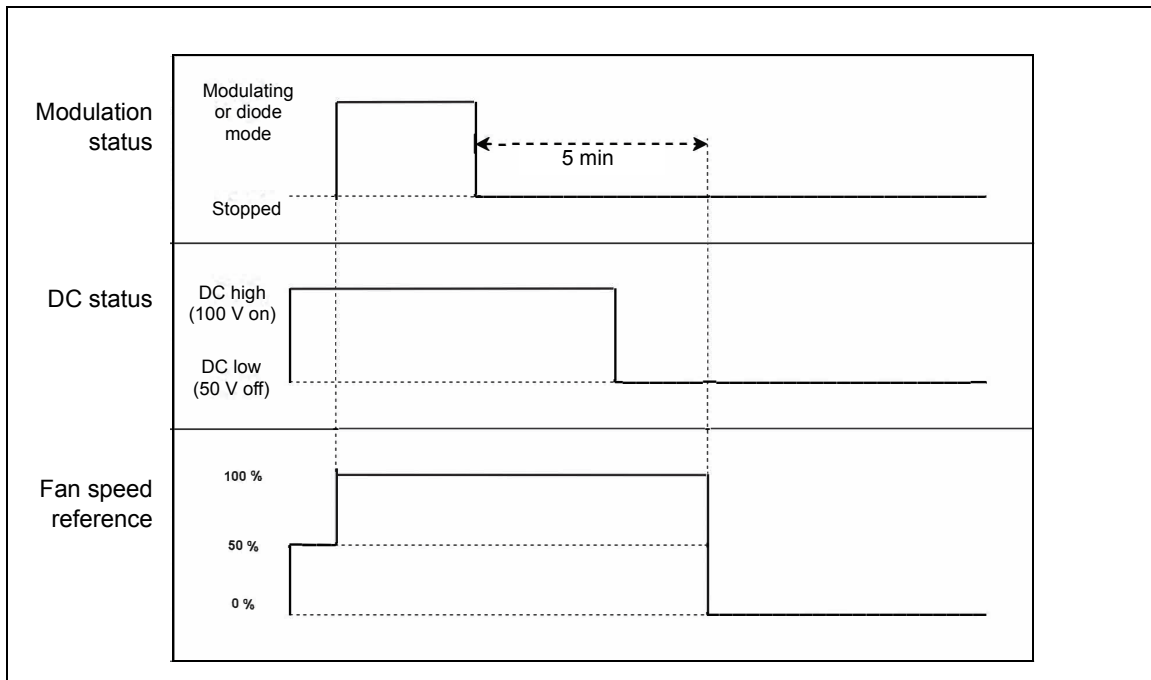

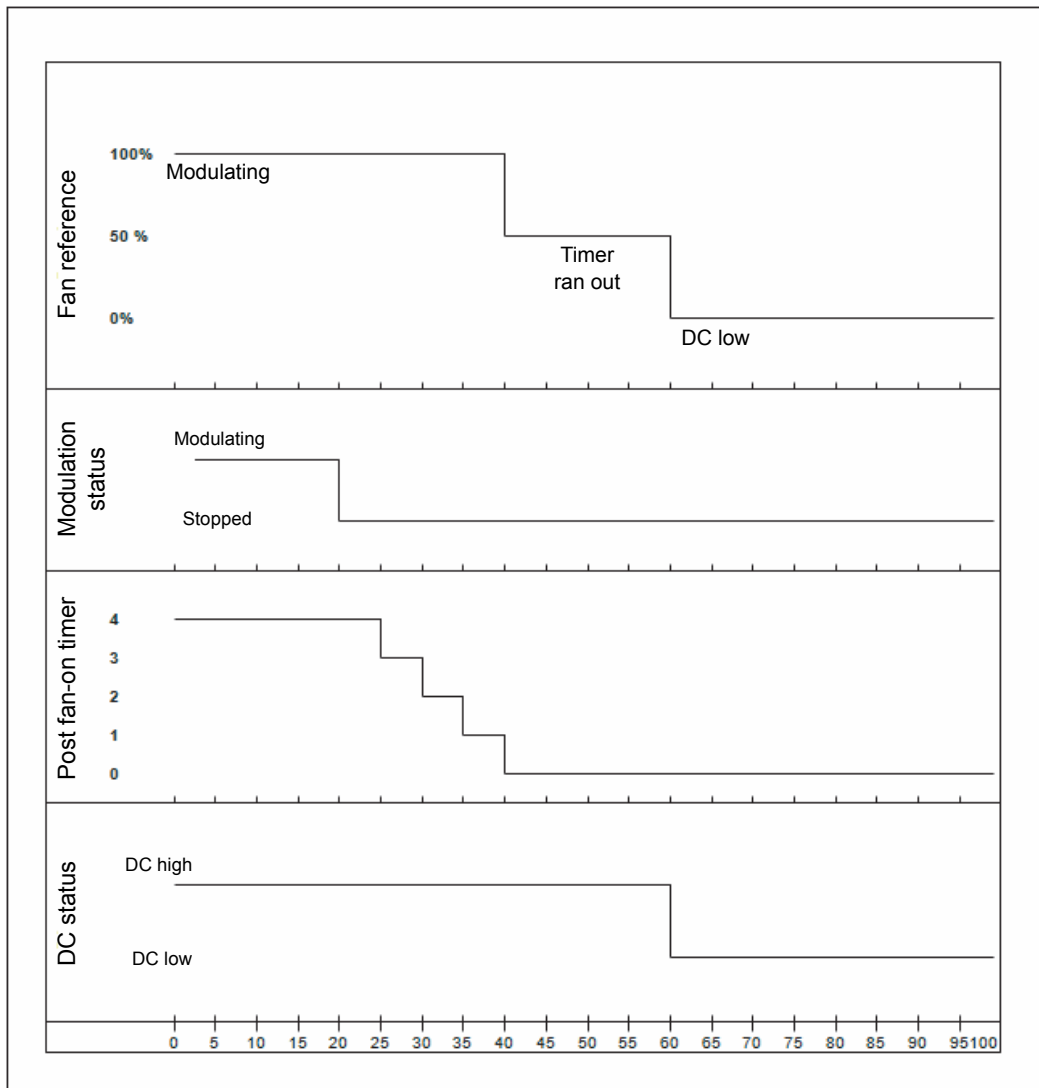

4

Mechanical installation

Contents of this chapter

This chapter contains instructions on installing the module.

Necessary tools and instructions

See the applicable drive hardware manual.

Unpacking and examining the delivery

1. Open the package.
2. Make sure that the package contains the items ordered.
3. Make sure that there are no signs of damage.



Installing the module



WARNING! Obey the safety instructions. See chapter [Safety instructions](#) on page 9. If you ignore the safety instructions, injury or death can occur.

Install the CIO-01 module in a heated indoor environment. Ensure that the ambient conditions meet the requirements given in [Ambient conditions](#) on page 56.

Fasten the module with screws on its corner holes.

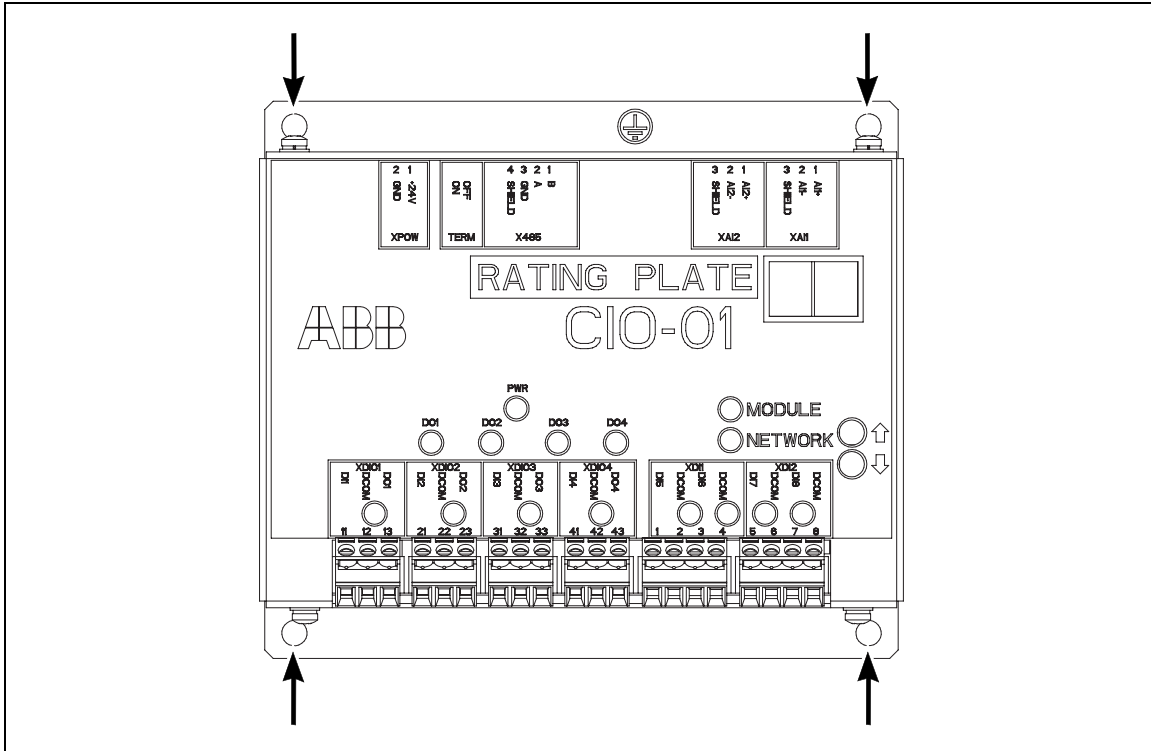

Grounding the module

Fasten the module with screws on a conducting surface. If needed, use an additional grounding wire under the screw.

5

Electrical installation

Contents of this chapter

This chapter contains instructions on wiring the module.

Warnings



WARNING! Obey the safety instructions. See chapter [Safety instructions](#) on page 9. If you ignore the safety instructions, injury or death can occur.

Necessary tools and instructions

See the applicable drive hardware manual.



Terminal designations

Connectors of the CIO-01 module and their default use is shown below. For further details on wiring, see the delivery-specific circuit diagrams.

Digital input/outputs		XDIO1...XDIO4	
DI1: Monitoring of fan 1	DI1	11	
	DCOM	12	
DO1: Control of fan 1 (PWM output)	DO1	13	
	DI2: Monitoring of fan 2	DI2	21
DO2: Control of fan 2 (PWM output)	DCOM	22	
	DO2	23	
DI3: Monitoring of fan 3	DI3	31	
	DCOM	32	
DO3: Control of fan 3 (PWM output)	DO3	33	
	DI4: Monitoring of fan 4	DI4	41
DO4: Control of fan 4 (PWM output)	DCOM	42	
	DO4	43	
Digital inputs		XDI1, XDI2	
DI5: Miniature circuit breaker monitoring (0 = related warning or fault is given)	DI5	1	
	DCOM	2	
DI6: Fuse monitoring (0 = related warning or fault is given)	DI6	3	
	DCOM	4	
DI7: Reserved for internal use.	DI7	5	
	DCOM	6	
DI8: Not in use by default. Can be used for any purpose by using IEC program or general supervision function of the firmware. (0 = related warning or fault is given)	DI8	7	
	DCOM	8	
Analog inputs		XAI1, XAI2	
AI1: (NTC. Not in use.)	AI1+	1	
	AI1-	2	
	SHIELD	3	
AI2: (NTC. Not in use.)	AI2+	1	
	AI2-	2	
	SHIELD	3	
RS-485 communication link		X485	
RS-485 communication link. Connected to XD2D connector of the ZCU control unit, or X485 connector of the BCU control unit.	B	1	
	A	2	
	GND	3	
	SHIELD	4	
I/O bus termination		TERM	
Termination resistor	ON	<input type="checkbox"/>	OFF
Power supply		XPOW	
24 V DC	+24V	1	
	GND	2	

General cabling instructions

Connect the +24 V external power supply to the control unit connector XPOW.

For general electrical installation instructions, see *Safety instructions for ACS880 liquid-cooled multidrive cabinets and modules* (3AXD50000048633 [English]).

Wiring

Connect the external control cables to the applicable module terminals.

■ Wiring example

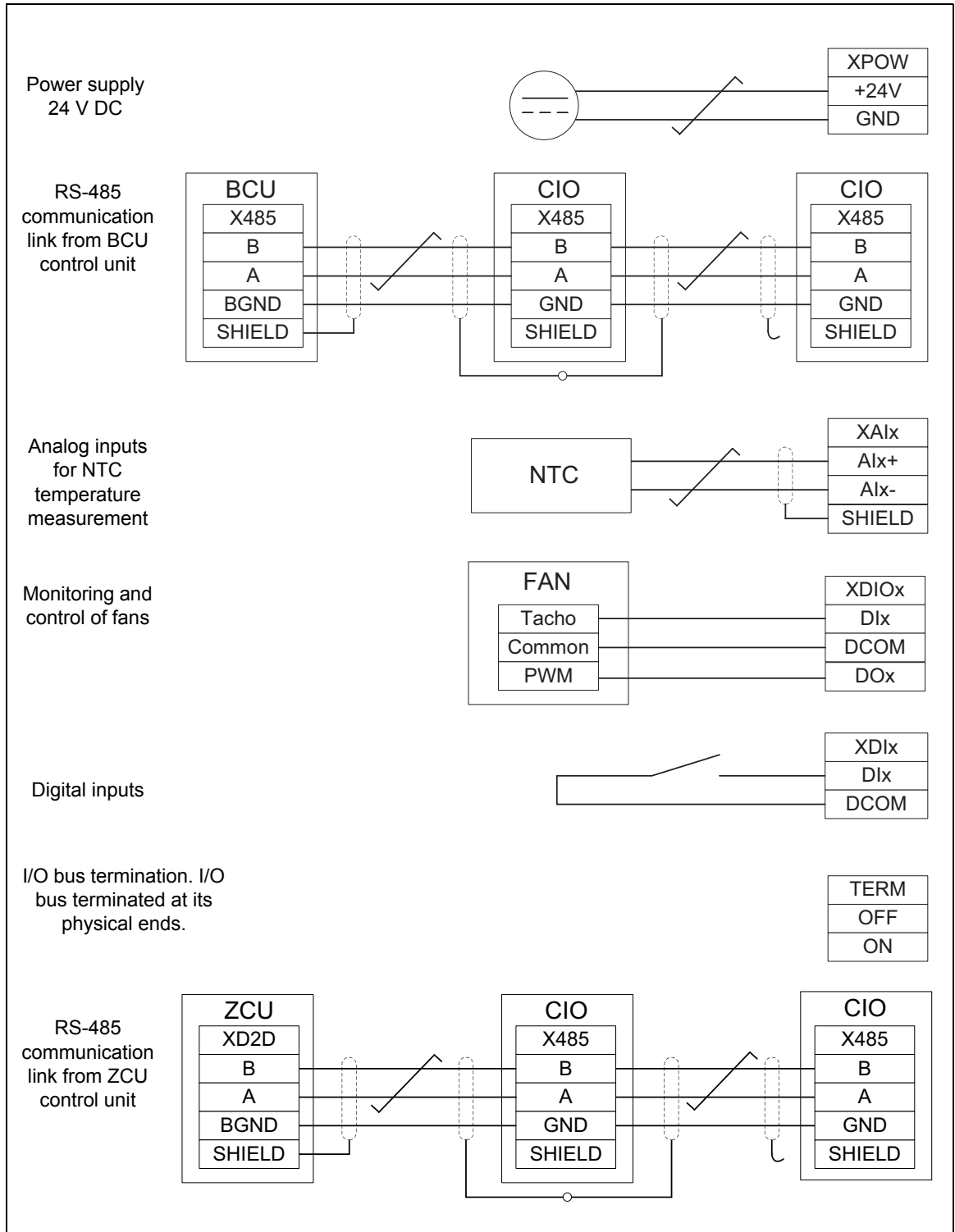



6

Start-up

Contents of this chapter

This chapter describes the basic start-up procedure of the distributed I/O bus.



Start-up procedure

Tasks	<input checked="" type="checkbox"/>
Safety	
 WARNING! Obey the safety instructions during the start-up procedure. See <i>Safety instructions for ACS880 multidrive cabinets and modules</i> (3AUA0000102301 [English]) for air-cooled modules, and <i>Safety instructions for ACS880 liquid-cooled multidrive cabinets and modules</i> (3AXD50000048633 [English]) for liquid-cooled modules. If you ignore the safety instructions, injury or death, or damage to the equipment can occur.	<input type="checkbox"/>
Hardware settings	
Check the mechanical and electrical installation of the drive. See the hardware manual.	<input type="checkbox"/>
Terminate the I/O bus at its physical ends: set the termination resistor switch of the CIO-01 module on the other end of the I/O bus to ON position, and terminate the other end of the I/O bus on the ZCU or BCU control unit. Set intermediate termination resistors to OFF position. Note: When using a ZCU control unit as an I/O bus master, make sure that ZCU control unit is of type ZCU-14 rev. B or later.	<input type="checkbox"/>
Switch on the auxiliary power to the CIO-01 modules. Note: Main supply for cabinet fan(s) must remain switched off.	<input type="checkbox"/>
Set the correct node number to each CIO-01 module (or make sure that the correct node number is set): use the up and down buttons of the CIO-01 module.	<input type="checkbox"/>
Parameter settings	
Set parameter <i>206.01 I/O bus enable</i> to <i>Yes</i> . <u>ACS880-07CLC</u> : Set bit 15 of parameter <i>195.20 HW options word 1</i> .	<input type="checkbox"/>
Activate the CIO-01 modules by selecting the node numbers with parameter <i>206.18 Node activation</i> .	<input type="checkbox"/>
Set fan activation parameters <i>206.20...206.23</i> according to the connected fans.	<input type="checkbox"/>
Verify that all nodes communicate without errors. You can use parameters of parameter group <i>208 I/O bus diagnostics</i> to help in verification and debugging.	<input type="checkbox"/>
Switch on the main supply for the cabinet fan(s).	<input type="checkbox"/>
Close the cabinet doors before performing identification run to guarantee normal operation conditions concerning air flow. On the first start, the control program performs identification run for the fans to detect the 100% rotation speed level. Identification run is performed whenever the control program detects fans without existing identification run results and fans are commanded to start. When the identification run is finished, the control program shows the detected results (100% level feedback pulse frequencies) in the parameters of parameter group <i>209 I/O bus fan identification</i> for each fan. The fans are ready for use. Note: <ul style="list-style-type: none"> • Verify that the detected feedback pulse frequencies are reasonable for the fan types. For allowed reference speed ranges, see the sticker inside each cabinet door. • Every start of fans performs the identification run for fans that do not have an existing result available. • If fans are later replaced with new ones, identification run result and internal run-time counters on the CIO-01 module need to be reset. To reset, set parameter <i>207.03 Command selection</i> to <i>Reset fan data</i> and trigger the operation with parameter <i>207.10 Service request trigger</i> for the selected node. • If CIO-01 module is replaced, all the fans connected to the replaced CIO-01 module need to be replaced as well. Otherwise the run-time supervision does not work properly. 	<input type="checkbox"/>
Review the parameters of parameter group <i>206 I/O bus configuration</i> to guarantee that supervision limits etc. are suitable for the application.	<input type="checkbox"/>





7

Program features

Contents of this chapter

This chapter describes the features supported by the control program.

Overview

Distributed I/O bus controls and supervises each cabinet fan separately. It detects malfunctioning fans and indicates them with warning or fault messages. The control program performs identification run for cabinet fans to detect nominal speed values of the fans.

Typically, the control unit of the supply unit acts as an I/O bus master. Cabinet fans in drive cubicles are controlled with separate PWM (pulse-width modulation) outputs. When the control program detects a malfunctioning fan, DDCS communication delivers the warning code from the supply unit to the inverter unit. You can access the settings of the distributed I/O bus via panel bus or Drive composer PC tool.

Basic configuration of the distributed I/O bus

Distributed I/O bus is taken into use with parameter [206.01 I/O bus enable](#). User can define warning and fault limits for fan speed ([206.06](#) and [206.07](#)) and communication break ([206.09](#)). User activates monitoring and control for fans with parameters [206.20...206.23](#), and activates the nodes with parameter [206.18 Node activation](#). The control program shows malfunctioning fans in parameters [206.30...206.33](#).

■ Settings

Parameters: parameter group [206 I/O bus configuration](#)

Service request parameters

User can select certain read and reset requests for the distributed I/O bus ([207.03](#)). Selected request is performed with parameter [207.10](#), and the control program shows the output of the operation in parameters [207.11...207.14](#) for each fan when applicable.

■ Settings

Parameters: parameter group [207 I/O bus service](#)

Diagnostic counters

The control program displays amounts of messages (packets) sent by master ([208.01](#), [208.02](#)), and certain errors ([208.03...208.05](#)) on the distributed I/O bus. Parameters [208.11...208.26](#) show the amount of timeouts for each node, and parameter [208.06](#) shows the sum of timeouts in all nodes. User can reset error and timeout counters ([208.80](#)).

■ Settings

Parameters: parameter group [208 I/O bus diagnostics](#)

Identification run of the fans

An identification run is performed whenever there are no existing identification run results for a fan and fans are commanded to start. Identification run is performed to detect the 100% rotation speed level of a fan. The identification sequence may take several minutes, during which the fans that are being identified run at full speed. After the identification procedure is successfully completed, the identified fans are given the regular fan reference which may be other than 100%.

The control program shows detected results of the identification run in parameters [209.01...209.64](#) for each fan. User can reset the last identification run result through the I/O bus service parameter group [207 I/O bus service](#).

■ Settings

Parameters: parameter group [209 I/O bus fan identification](#)

8

Parameters

Contents of this chapter

This chapter describes the actual signals and parameters related to the distributed I/O bus.

For details of other parameters, see *ACS880 diode supply control program firmware manual* (3AUA0000103295 [English]), or *ACS880 IGBT supply control program firmware manual* (3AUA0000131562 [English]).

Terms and abbreviations

Term	Definition
Actual signal	Type of <i>parameter</i> that is the result of a measurement or calculation by the supply unit, or contains status information. Most actual signals are read-only, but some (especially counter-type actual signals) can be reset.
Def	(In the following table, shown on the same row as the parameter name) The default value of a <i>parameter</i> .
FbEq16	(In the following table, shown on the same row as the parameter range, or for each selection) 16-bit fieldbus equivalent: The scaling between the integer used in communication and the value shown on the panel when a 16-bit value is selected for transmission to an external system. A dash (-) indicates that the parameter is not accessible in 16-bit format. The corresponding 32-bit scalings are listed in chapter <i>Additional parameter data</i> (page 43).
Other	The value is taken from another source.
Parameter	Either an user-adjustable operating instruction for the supply unit, or an <i>actual signal</i> .
p.u.	Per unit

Summary of parameter groups

Group	Contents	Page
206 I/O bus configuration	Basic configuration of the distributed I/O bus.	31
207 I/O bus service	Service request parameters for selected node.	37
208 I/O bus diagnostics	Diagnostic counters of the distributed I/O bus.	38
209 I/O bus fan identification	Results of the identification run of the fan.	39

Parameter listing

No.	Name/Value	Description	Def/FbEq16																																																			
206 I/O bus configuration		Basic configuration of the distributed I/O bus.																																																				
206.01 I/O bus enable		Enables/disables the use of distributed I/O bus.	No																																																			
	No	Distributed I/O bus is disabled.	0																																																			
	Yes	Distributed I/O bus is enabled.	1																																																			
206.06 Fan speed warning limit		Defines the warning limit for fan speed. When fan speed is below the value given with this parameter (in relation to requested reference), the control program generates warning AE92 Fan speed . Parameter value 0 means that no warning will be generated.	75.0%																																																			
	0.0...100.0%	Warning limit for fan speed.	1 = 1%																																																			
206.07 Fan speed fault limit		Defines the fault limit for fan speed. When fan speed is below the value given with this parameter (in relation to requested reference), the control program generates fault 8E12 Fan speed . Parameter value 0 means that no fault will be generated.	50.0%																																																			
	0.0...100.0%	Fault limit for fan speed.	1 = 1%																																																			
206.08 Fan on-time warning limit		Defines the warning limit for fan lifetime. When the fan has been running longer (in hours) than the value given with this parameter, the control program generates warning AE91 Fan lifetime exceeded .	90000 h																																																			
	0...596523 h	Warning limit for fan lifetime.	1 = 1 h																																																			
206.09 Communication loss time		Defines a timeout for monitoring a node. The control program monitors whether an active node can not be found on the I/O bus. If a communication break lasts longer than the timeout, the control program generates warning AE90 I/O bus communication .	2 s																																																			
	0...600 s	Communication loss time.	1 = 1 s																																																			
206.18 Node activation		Activates communication for nodes 1...16.	0000h																																																			
		<table border="1"> <thead> <tr> <th>Bit</th> <th>Name</th> <th>Description</th> </tr> </thead> <tbody> <tr><td>0</td><td>Node 1</td><td>1 = Node 1 is active.</td></tr> <tr><td>1</td><td>Node 2</td><td>1 = Node 2 is active.</td></tr> <tr><td>2</td><td>Node 3</td><td>1 = Node 3 is active.</td></tr> <tr><td>3</td><td>Node 4</td><td>1 = Node 4 is active.</td></tr> <tr><td>4</td><td>Node 5</td><td>1 = Node 5 is active.</td></tr> <tr><td>5</td><td>Node 6</td><td>1 = Node 6 is active.</td></tr> <tr><td>6</td><td>Node 7</td><td>1 = Node 7 is active.</td></tr> <tr><td>7</td><td>Node 8</td><td>1 = Node 8 is active.</td></tr> <tr><td>8</td><td>Node 9</td><td>1 = Node 9 is active.</td></tr> <tr><td>9</td><td>Node 10</td><td>1 = Node 10 is active.</td></tr> <tr><td>10</td><td>Node 11</td><td>1 = Node 11 is active.</td></tr> <tr><td>11</td><td>Node 12</td><td>1 = Node 12 is active.</td></tr> <tr><td>12</td><td>Node 13</td><td>1 = Node 13 is active.</td></tr> <tr><td>13</td><td>Node 14</td><td>1 = Node 14 is active.</td></tr> <tr><td>14</td><td>Node 15</td><td>1 = Node 15 is active.</td></tr> <tr><td>15</td><td>Node 16</td><td>1 = Node 16 is active.</td></tr> </tbody> </table>	Bit	Name	Description	0	Node 1	1 = Node 1 is active.	1	Node 2	1 = Node 2 is active.	2	Node 3	1 = Node 3 is active.	3	Node 4	1 = Node 4 is active.	4	Node 5	1 = Node 5 is active.	5	Node 6	1 = Node 6 is active.	6	Node 7	1 = Node 7 is active.	7	Node 8	1 = Node 8 is active.	8	Node 9	1 = Node 9 is active.	9	Node 10	1 = Node 10 is active.	10	Node 11	1 = Node 11 is active.	11	Node 12	1 = Node 12 is active.	12	Node 13	1 = Node 13 is active.	13	Node 14	1 = Node 14 is active.	14	Node 15	1 = Node 15 is active.	15	Node 16	1 = Node 16 is active.	
Bit	Name	Description																																																				
0	Node 1	1 = Node 1 is active.																																																				
1	Node 2	1 = Node 2 is active.																																																				
2	Node 3	1 = Node 3 is active.																																																				
3	Node 4	1 = Node 4 is active.																																																				
4	Node 5	1 = Node 5 is active.																																																				
5	Node 6	1 = Node 6 is active.																																																				
6	Node 7	1 = Node 7 is active.																																																				
7	Node 8	1 = Node 8 is active.																																																				
8	Node 9	1 = Node 9 is active.																																																				
9	Node 10	1 = Node 10 is active.																																																				
10	Node 11	1 = Node 11 is active.																																																				
11	Node 12	1 = Node 12 is active.																																																				
12	Node 13	1 = Node 13 is active.																																																				
13	Node 14	1 = Node 14 is active.																																																				
14	Node 15	1 = Node 15 is active.																																																				
15	Node 16	1 = Node 16 is active.																																																				
	0000h...FFFFh	Activated nodes.	1 = 1																																																			

32 Parameters

No.	Name/Value	Description	Def/FbEq16																																																			
206.20	<i>Fan activation nodes 1-4</i>	Activates monitoring and control for fans of nodes 1...4.	0000h																																																			
<table border="1"> <thead> <tr> <th>Bit</th> <th>Name</th> <th>Description</th> </tr> </thead> <tbody> <tr><td>0</td><td>Node 1 fan 1</td><td>1 = Fan 1 of node 1 is active.</td></tr> <tr><td>1</td><td>Node 1 fan 2</td><td>1 = Fan 2 of node 1 is active.</td></tr> <tr><td>2</td><td>Node 1 fan 3</td><td>1 = Fan 3 of node 1 is active.</td></tr> <tr><td>3</td><td>Node 1 fan 4</td><td>1 = Fan 4 of node 1 is active.</td></tr> <tr><td>4</td><td>Node 2 fan 1</td><td>1 = Fan 1 of node 2 is active.</td></tr> <tr><td>5</td><td>Node 2 fan 2</td><td>1 = Fan 2 of node 2 is active.</td></tr> <tr><td>6</td><td>Node 2 fan 3</td><td>1 = Fan 3 of node 2 is active.</td></tr> <tr><td>7</td><td>Node 2 fan 4</td><td>1 = Fan 4 of node 2 is active.</td></tr> <tr><td>8</td><td>Node 3 fan 1</td><td>1 = Fan 1 of node 3 is active.</td></tr> <tr><td>9</td><td>Node 3 fan 2</td><td>1 = Fan 2 of node 3 is active.</td></tr> <tr><td>10</td><td>Node 3 fan 3</td><td>1 = Fan 3 of node 3 is active.</td></tr> <tr><td>11</td><td>Node 3 fan 4</td><td>1 = Fan 4 of node 3 is active.</td></tr> <tr><td>12</td><td>Node 4 fan 1</td><td>1 = Fan 1 of node 4 is active.</td></tr> <tr><td>13</td><td>Node 4 fan 2</td><td>1 = Fan 2 of node 4 is active.</td></tr> <tr><td>14</td><td>Node 4 fan 3</td><td>1 = Fan 3 of node 4 is active.</td></tr> <tr><td>15</td><td>Node 4 fan 4</td><td>1 = Fan 4 of node 4 is active.</td></tr> </tbody> </table>				Bit	Name	Description	0	Node 1 fan 1	1 = Fan 1 of node 1 is active.	1	Node 1 fan 2	1 = Fan 2 of node 1 is active.	2	Node 1 fan 3	1 = Fan 3 of node 1 is active.	3	Node 1 fan 4	1 = Fan 4 of node 1 is active.	4	Node 2 fan 1	1 = Fan 1 of node 2 is active.	5	Node 2 fan 2	1 = Fan 2 of node 2 is active.	6	Node 2 fan 3	1 = Fan 3 of node 2 is active.	7	Node 2 fan 4	1 = Fan 4 of node 2 is active.	8	Node 3 fan 1	1 = Fan 1 of node 3 is active.	9	Node 3 fan 2	1 = Fan 2 of node 3 is active.	10	Node 3 fan 3	1 = Fan 3 of node 3 is active.	11	Node 3 fan 4	1 = Fan 4 of node 3 is active.	12	Node 4 fan 1	1 = Fan 1 of node 4 is active.	13	Node 4 fan 2	1 = Fan 2 of node 4 is active.	14	Node 4 fan 3	1 = Fan 3 of node 4 is active.	15	Node 4 fan 4	1 = Fan 4 of node 4 is active.
Bit	Name	Description																																																				
0	Node 1 fan 1	1 = Fan 1 of node 1 is active.																																																				
1	Node 1 fan 2	1 = Fan 2 of node 1 is active.																																																				
2	Node 1 fan 3	1 = Fan 3 of node 1 is active.																																																				
3	Node 1 fan 4	1 = Fan 4 of node 1 is active.																																																				
4	Node 2 fan 1	1 = Fan 1 of node 2 is active.																																																				
5	Node 2 fan 2	1 = Fan 2 of node 2 is active.																																																				
6	Node 2 fan 3	1 = Fan 3 of node 2 is active.																																																				
7	Node 2 fan 4	1 = Fan 4 of node 2 is active.																																																				
8	Node 3 fan 1	1 = Fan 1 of node 3 is active.																																																				
9	Node 3 fan 2	1 = Fan 2 of node 3 is active.																																																				
10	Node 3 fan 3	1 = Fan 3 of node 3 is active.																																																				
11	Node 3 fan 4	1 = Fan 4 of node 3 is active.																																																				
12	Node 4 fan 1	1 = Fan 1 of node 4 is active.																																																				
13	Node 4 fan 2	1 = Fan 2 of node 4 is active.																																																				
14	Node 4 fan 3	1 = Fan 3 of node 4 is active.																																																				
15	Node 4 fan 4	1 = Fan 4 of node 4 is active.																																																				
0000h...FFFFh		Fans activated in nodes 1...4.	1 = 1																																																			
206.21	<i>Fan activation nodes 5-8</i>	Activates monitoring and control for fans of nodes 5...8.	0000h																																																			
<table border="1"> <thead> <tr> <th>Bit</th> <th>Name</th> <th>Description</th> </tr> </thead> <tbody> <tr><td>0</td><td>Node 5 fan 1</td><td>1 = Fan 1 of node 5 is active.</td></tr> <tr><td>1</td><td>Node 5 fan 2</td><td>1 = Fan 2 of node 5 is active.</td></tr> <tr><td>2</td><td>Node 5 fan 3</td><td>1 = Fan 3 of node 5 is active.</td></tr> <tr><td>3</td><td>Node 5 fan 4</td><td>1 = Fan 4 of node 5 is active.</td></tr> <tr><td>4</td><td>Node 6 fan 1</td><td>1 = Fan 1 of node 6 is active.</td></tr> <tr><td>5</td><td>Node 6 fan 2</td><td>1 = Fan 2 of node 6 is active.</td></tr> <tr><td>6</td><td>Node 6 fan 3</td><td>1 = Fan 3 of node 6 is active.</td></tr> <tr><td>7</td><td>Node 6 fan 4</td><td>1 = Fan 4 of node 6 is active.</td></tr> <tr><td>8</td><td>Node 7 fan 1</td><td>1 = Fan 1 of node 7 is active.</td></tr> <tr><td>9</td><td>Node 7 fan 2</td><td>1 = Fan 2 of node 7 is active.</td></tr> <tr><td>10</td><td>Node 7 fan 3</td><td>1 = Fan 3 of node 7 is active.</td></tr> <tr><td>11</td><td>Node 7 fan 4</td><td>1 = Fan 4 of node 7 is active.</td></tr> <tr><td>12</td><td>Node 8 fan 1</td><td>1 = Fan 1 of node 8 is active.</td></tr> <tr><td>13</td><td>Node 8 fan 2</td><td>1 = Fan 2 of node 8 is active.</td></tr> <tr><td>14</td><td>Node 8 fan 3</td><td>1 = Fan 3 of node 8 is active.</td></tr> <tr><td>15</td><td>Node 8 fan 4</td><td>1 = Fan 4 of node 8 is active.</td></tr> </tbody> </table>				Bit	Name	Description	0	Node 5 fan 1	1 = Fan 1 of node 5 is active.	1	Node 5 fan 2	1 = Fan 2 of node 5 is active.	2	Node 5 fan 3	1 = Fan 3 of node 5 is active.	3	Node 5 fan 4	1 = Fan 4 of node 5 is active.	4	Node 6 fan 1	1 = Fan 1 of node 6 is active.	5	Node 6 fan 2	1 = Fan 2 of node 6 is active.	6	Node 6 fan 3	1 = Fan 3 of node 6 is active.	7	Node 6 fan 4	1 = Fan 4 of node 6 is active.	8	Node 7 fan 1	1 = Fan 1 of node 7 is active.	9	Node 7 fan 2	1 = Fan 2 of node 7 is active.	10	Node 7 fan 3	1 = Fan 3 of node 7 is active.	11	Node 7 fan 4	1 = Fan 4 of node 7 is active.	12	Node 8 fan 1	1 = Fan 1 of node 8 is active.	13	Node 8 fan 2	1 = Fan 2 of node 8 is active.	14	Node 8 fan 3	1 = Fan 3 of node 8 is active.	15	Node 8 fan 4	1 = Fan 4 of node 8 is active.
Bit	Name	Description																																																				
0	Node 5 fan 1	1 = Fan 1 of node 5 is active.																																																				
1	Node 5 fan 2	1 = Fan 2 of node 5 is active.																																																				
2	Node 5 fan 3	1 = Fan 3 of node 5 is active.																																																				
3	Node 5 fan 4	1 = Fan 4 of node 5 is active.																																																				
4	Node 6 fan 1	1 = Fan 1 of node 6 is active.																																																				
5	Node 6 fan 2	1 = Fan 2 of node 6 is active.																																																				
6	Node 6 fan 3	1 = Fan 3 of node 6 is active.																																																				
7	Node 6 fan 4	1 = Fan 4 of node 6 is active.																																																				
8	Node 7 fan 1	1 = Fan 1 of node 7 is active.																																																				
9	Node 7 fan 2	1 = Fan 2 of node 7 is active.																																																				
10	Node 7 fan 3	1 = Fan 3 of node 7 is active.																																																				
11	Node 7 fan 4	1 = Fan 4 of node 7 is active.																																																				
12	Node 8 fan 1	1 = Fan 1 of node 8 is active.																																																				
13	Node 8 fan 2	1 = Fan 2 of node 8 is active.																																																				
14	Node 8 fan 3	1 = Fan 3 of node 8 is active.																																																				
15	Node 8 fan 4	1 = Fan 4 of node 8 is active.																																																				
0000h...FFFFh		Fans activated in nodes 5...8.	1 = 1																																																			

No.	Name/Value	Description	Def/FbEq16																																																			
206.22	<i>Fan activation nodes 9-12</i>	Activates monitoring and control for fans of nodes 9...12.	0000h																																																			
		<table border="1"> <thead> <tr> <th>Bit</th> <th>Name</th> <th>Description</th> </tr> </thead> <tbody> <tr><td>0</td><td>Node 9 fan 1</td><td>1 = Fan 1 of node 9 is active.</td></tr> <tr><td>1</td><td>Node 9 fan 2</td><td>1 = Fan 2 of node 9 is active.</td></tr> <tr><td>2</td><td>Node 9 fan 3</td><td>1 = Fan 3 of node 9 is active.</td></tr> <tr><td>3</td><td>Node 9 fan 4</td><td>1 = Fan 4 of node 9 is active.</td></tr> <tr><td>4</td><td>Node 10 fan 1</td><td>1 = Fan 1 of node 10 is active.</td></tr> <tr><td>5</td><td>Node 10 fan 2</td><td>1 = Fan 2 of node 10 is active.</td></tr> <tr><td>6</td><td>Node 10 fan 3</td><td>1 = Fan 3 of node 10 is active.</td></tr> <tr><td>7</td><td>Node 10 fan 4</td><td>1 = Fan 4 of node 10 is active.</td></tr> <tr><td>8</td><td>Node 11 fan 1</td><td>1 = Fan 1 of node 11 is active.</td></tr> <tr><td>9</td><td>Node 11 fan 2</td><td>1 = Fan 2 of node 11 is active.</td></tr> <tr><td>10</td><td>Node 11 fan 3</td><td>1 = Fan 3 of node 11 is active.</td></tr> <tr><td>11</td><td>Node 11 fan 4</td><td>1 = Fan 4 of node 11 is active.</td></tr> <tr><td>12</td><td>Node 12 fan 1</td><td>1 = Fan 1 of node 12 is active.</td></tr> <tr><td>13</td><td>Node 12 fan 2</td><td>1 = Fan 2 of node 12 is active.</td></tr> <tr><td>14</td><td>Node 12 fan 3</td><td>1 = Fan 3 of node 12 is active.</td></tr> <tr><td>15</td><td>Node 12 fan 4</td><td>1 = Fan 4 of node 12 is active.</td></tr> </tbody> </table>	Bit	Name	Description	0	Node 9 fan 1	1 = Fan 1 of node 9 is active.	1	Node 9 fan 2	1 = Fan 2 of node 9 is active.	2	Node 9 fan 3	1 = Fan 3 of node 9 is active.	3	Node 9 fan 4	1 = Fan 4 of node 9 is active.	4	Node 10 fan 1	1 = Fan 1 of node 10 is active.	5	Node 10 fan 2	1 = Fan 2 of node 10 is active.	6	Node 10 fan 3	1 = Fan 3 of node 10 is active.	7	Node 10 fan 4	1 = Fan 4 of node 10 is active.	8	Node 11 fan 1	1 = Fan 1 of node 11 is active.	9	Node 11 fan 2	1 = Fan 2 of node 11 is active.	10	Node 11 fan 3	1 = Fan 3 of node 11 is active.	11	Node 11 fan 4	1 = Fan 4 of node 11 is active.	12	Node 12 fan 1	1 = Fan 1 of node 12 is active.	13	Node 12 fan 2	1 = Fan 2 of node 12 is active.	14	Node 12 fan 3	1 = Fan 3 of node 12 is active.	15	Node 12 fan 4	1 = Fan 4 of node 12 is active.	
Bit	Name	Description																																																				
0	Node 9 fan 1	1 = Fan 1 of node 9 is active.																																																				
1	Node 9 fan 2	1 = Fan 2 of node 9 is active.																																																				
2	Node 9 fan 3	1 = Fan 3 of node 9 is active.																																																				
3	Node 9 fan 4	1 = Fan 4 of node 9 is active.																																																				
4	Node 10 fan 1	1 = Fan 1 of node 10 is active.																																																				
5	Node 10 fan 2	1 = Fan 2 of node 10 is active.																																																				
6	Node 10 fan 3	1 = Fan 3 of node 10 is active.																																																				
7	Node 10 fan 4	1 = Fan 4 of node 10 is active.																																																				
8	Node 11 fan 1	1 = Fan 1 of node 11 is active.																																																				
9	Node 11 fan 2	1 = Fan 2 of node 11 is active.																																																				
10	Node 11 fan 3	1 = Fan 3 of node 11 is active.																																																				
11	Node 11 fan 4	1 = Fan 4 of node 11 is active.																																																				
12	Node 12 fan 1	1 = Fan 1 of node 12 is active.																																																				
13	Node 12 fan 2	1 = Fan 2 of node 12 is active.																																																				
14	Node 12 fan 3	1 = Fan 3 of node 12 is active.																																																				
15	Node 12 fan 4	1 = Fan 4 of node 12 is active.																																																				
	0000h...FFFFh	Fans activated in nodes 9...12.	1 = 1																																																			
206.23	<i>Fan activation nodes 13-16</i>	Activates monitoring and control for fans of nodes 13...16.	0000h																																																			
		<table border="1"> <thead> <tr> <th>Bit</th> <th>Name</th> <th>Description</th> </tr> </thead> <tbody> <tr><td>0</td><td>Node 13 fan 1</td><td>1 = Fan 1 of node 13 is active.</td></tr> <tr><td>1</td><td>Node 13 fan 2</td><td>1 = Fan 2 of node 13 is active.</td></tr> <tr><td>2</td><td>Node 13 fan 3</td><td>1 = Fan 3 of node 13 is active.</td></tr> <tr><td>3</td><td>Node 13 fan 4</td><td>1 = Fan 4 of node 13 is active.</td></tr> <tr><td>4</td><td>Node 14 fan 1</td><td>1 = Fan 1 of node 14 is active.</td></tr> <tr><td>5</td><td>Node 14 fan 2</td><td>1 = Fan 2 of node 14 is active.</td></tr> <tr><td>6</td><td>Node 14 fan 3</td><td>1 = Fan 3 of node 14 is active.</td></tr> <tr><td>7</td><td>Node 14 fan 4</td><td>1 = Fan 4 of node 14 is active.</td></tr> <tr><td>8</td><td>Node 15 fan 1</td><td>1 = Fan 1 of node 15 is active.</td></tr> <tr><td>9</td><td>Node 15 fan 2</td><td>1 = Fan 2 of node 15 is active.</td></tr> <tr><td>10</td><td>Node 15 fan 3</td><td>1 = Fan 3 of node 15 is active.</td></tr> <tr><td>11</td><td>Node 15 fan 4</td><td>1 = Fan 4 of node 15 is active.</td></tr> <tr><td>12</td><td>Node 16 fan 1</td><td>1 = Fan 1 of node 16 is active.</td></tr> <tr><td>13</td><td>Node 16 fan 2</td><td>1 = Fan 2 of node 16 is active.</td></tr> <tr><td>14</td><td>Node 16 fan 3</td><td>1 = Fan 3 of node 16 is active.</td></tr> <tr><td>15</td><td>Node 16 fan 4</td><td>1 = Fan 4 of node 16 is active.</td></tr> </tbody> </table>	Bit	Name	Description	0	Node 13 fan 1	1 = Fan 1 of node 13 is active.	1	Node 13 fan 2	1 = Fan 2 of node 13 is active.	2	Node 13 fan 3	1 = Fan 3 of node 13 is active.	3	Node 13 fan 4	1 = Fan 4 of node 13 is active.	4	Node 14 fan 1	1 = Fan 1 of node 14 is active.	5	Node 14 fan 2	1 = Fan 2 of node 14 is active.	6	Node 14 fan 3	1 = Fan 3 of node 14 is active.	7	Node 14 fan 4	1 = Fan 4 of node 14 is active.	8	Node 15 fan 1	1 = Fan 1 of node 15 is active.	9	Node 15 fan 2	1 = Fan 2 of node 15 is active.	10	Node 15 fan 3	1 = Fan 3 of node 15 is active.	11	Node 15 fan 4	1 = Fan 4 of node 15 is active.	12	Node 16 fan 1	1 = Fan 1 of node 16 is active.	13	Node 16 fan 2	1 = Fan 2 of node 16 is active.	14	Node 16 fan 3	1 = Fan 3 of node 16 is active.	15	Node 16 fan 4	1 = Fan 4 of node 16 is active.	
Bit	Name	Description																																																				
0	Node 13 fan 1	1 = Fan 1 of node 13 is active.																																																				
1	Node 13 fan 2	1 = Fan 2 of node 13 is active.																																																				
2	Node 13 fan 3	1 = Fan 3 of node 13 is active.																																																				
3	Node 13 fan 4	1 = Fan 4 of node 13 is active.																																																				
4	Node 14 fan 1	1 = Fan 1 of node 14 is active.																																																				
5	Node 14 fan 2	1 = Fan 2 of node 14 is active.																																																				
6	Node 14 fan 3	1 = Fan 3 of node 14 is active.																																																				
7	Node 14 fan 4	1 = Fan 4 of node 14 is active.																																																				
8	Node 15 fan 1	1 = Fan 1 of node 15 is active.																																																				
9	Node 15 fan 2	1 = Fan 2 of node 15 is active.																																																				
10	Node 15 fan 3	1 = Fan 3 of node 15 is active.																																																				
11	Node 15 fan 4	1 = Fan 4 of node 15 is active.																																																				
12	Node 16 fan 1	1 = Fan 1 of node 16 is active.																																																				
13	Node 16 fan 2	1 = Fan 2 of node 16 is active.																																																				
14	Node 16 fan 3	1 = Fan 3 of node 16 is active.																																																				
15	Node 16 fan 4	1 = Fan 4 of node 16 is active.																																																				
	0000h...FFFFh	Fans activated in nodes 13...16.	1 = 1																																																			

34 Parameters

No.	Name/Value	Description	Def/FbEq16																																																			
206.30	<i>Fan supervision status 1-4</i>	Shows statuses of fans in nodes 1...4.	0000h																																																			
<table border="1"> <thead> <tr> <th>Bit</th> <th>Name</th> <th>Description</th> </tr> </thead> <tbody> <tr><td>0</td><td>Node 1 fan 1 failure</td><td>1 = Failure in fan 1 of node 1.</td></tr> <tr><td>1</td><td>Node 1 fan 2 failure</td><td>1 = Failure in fan 2 of node 1.</td></tr> <tr><td>2</td><td>Node 1 fan 3 failure</td><td>1 = Failure in fan 3 of node 1.</td></tr> <tr><td>3</td><td>Node 1 fan 4 failure</td><td>1 = Failure in fan 4 of node 1.</td></tr> <tr><td>4</td><td>Node 2 fan 1 failure</td><td>1 = Failure in fan 1 of node 2.</td></tr> <tr><td>5</td><td>Node 2 fan 2 failure</td><td>1 = Failure in fan 2 of node 2.</td></tr> <tr><td>6</td><td>Node 2 fan 3 failure</td><td>1 = Failure in fan 3 of node 2.</td></tr> <tr><td>7</td><td>Node 2 fan 4 failure</td><td>1 = Failure in fan 4 of node 2.</td></tr> <tr><td>8</td><td>Node 3 fan 1 failure</td><td>1 = Failure in fan 1 of node 3.</td></tr> <tr><td>9</td><td>Node 3 fan 2 failure</td><td>1 = Failure in fan 2 of node 3.</td></tr> <tr><td>10</td><td>Node 3 fan 3 failure</td><td>1 = Failure in fan 3 of node 3.</td></tr> <tr><td>11</td><td>Node 3 fan 4 failure</td><td>1 = Failure in fan 4 of node 3.</td></tr> <tr><td>12</td><td>Node 4 fan 1 failure</td><td>1 = Failure in fan 1 of node 4.</td></tr> <tr><td>13</td><td>Node 4 fan 2 failure</td><td>1 = Failure in fan 2 of node 4.</td></tr> <tr><td>14</td><td>Node 4 fan 3 failure</td><td>1 = Failure in fan 3 of node 4.</td></tr> <tr><td>15</td><td>Node 4 fan 4 failure</td><td>1 = Failure in fan 4 of node 4.</td></tr> </tbody> </table>				Bit	Name	Description	0	Node 1 fan 1 failure	1 = Failure in fan 1 of node 1.	1	Node 1 fan 2 failure	1 = Failure in fan 2 of node 1.	2	Node 1 fan 3 failure	1 = Failure in fan 3 of node 1.	3	Node 1 fan 4 failure	1 = Failure in fan 4 of node 1.	4	Node 2 fan 1 failure	1 = Failure in fan 1 of node 2.	5	Node 2 fan 2 failure	1 = Failure in fan 2 of node 2.	6	Node 2 fan 3 failure	1 = Failure in fan 3 of node 2.	7	Node 2 fan 4 failure	1 = Failure in fan 4 of node 2.	8	Node 3 fan 1 failure	1 = Failure in fan 1 of node 3.	9	Node 3 fan 2 failure	1 = Failure in fan 2 of node 3.	10	Node 3 fan 3 failure	1 = Failure in fan 3 of node 3.	11	Node 3 fan 4 failure	1 = Failure in fan 4 of node 3.	12	Node 4 fan 1 failure	1 = Failure in fan 1 of node 4.	13	Node 4 fan 2 failure	1 = Failure in fan 2 of node 4.	14	Node 4 fan 3 failure	1 = Failure in fan 3 of node 4.	15	Node 4 fan 4 failure	1 = Failure in fan 4 of node 4.
Bit	Name	Description																																																				
0	Node 1 fan 1 failure	1 = Failure in fan 1 of node 1.																																																				
1	Node 1 fan 2 failure	1 = Failure in fan 2 of node 1.																																																				
2	Node 1 fan 3 failure	1 = Failure in fan 3 of node 1.																																																				
3	Node 1 fan 4 failure	1 = Failure in fan 4 of node 1.																																																				
4	Node 2 fan 1 failure	1 = Failure in fan 1 of node 2.																																																				
5	Node 2 fan 2 failure	1 = Failure in fan 2 of node 2.																																																				
6	Node 2 fan 3 failure	1 = Failure in fan 3 of node 2.																																																				
7	Node 2 fan 4 failure	1 = Failure in fan 4 of node 2.																																																				
8	Node 3 fan 1 failure	1 = Failure in fan 1 of node 3.																																																				
9	Node 3 fan 2 failure	1 = Failure in fan 2 of node 3.																																																				
10	Node 3 fan 3 failure	1 = Failure in fan 3 of node 3.																																																				
11	Node 3 fan 4 failure	1 = Failure in fan 4 of node 3.																																																				
12	Node 4 fan 1 failure	1 = Failure in fan 1 of node 4.																																																				
13	Node 4 fan 2 failure	1 = Failure in fan 2 of node 4.																																																				
14	Node 4 fan 3 failure	1 = Failure in fan 3 of node 4.																																																				
15	Node 4 fan 4 failure	1 = Failure in fan 4 of node 4.																																																				
0000h...FFFFh		Fans failed in nodes 1...4.	1 = 1																																																			
206.31	<i>Fan supervision status 5-8</i>	Shows statuses of fans in nodes 5...8.	0000h																																																			
<table border="1"> <thead> <tr> <th>Bit</th> <th>Name</th> <th>Description</th> </tr> </thead> <tbody> <tr><td>0</td><td>Node 5 fan 1 failure</td><td>1 = Failure in fan 1 of node 5.</td></tr> <tr><td>1</td><td>Node 5 fan 2 failure</td><td>1 = Failure in fan 2 of node 5.</td></tr> <tr><td>2</td><td>Node 5 fan 3 failure</td><td>1 = Failure in fan 3 of node 5.</td></tr> <tr><td>3</td><td>Node 5 fan 4 failure</td><td>1 = Failure in fan 4 of node 5.</td></tr> <tr><td>4</td><td>Node 6 fan 1 failure</td><td>1 = Failure in fan 1 of node 6.</td></tr> <tr><td>5</td><td>Node 6 fan 2 failure</td><td>1 = Failure in fan 2 of node 6.</td></tr> <tr><td>6</td><td>Node 6 fan 3 failure</td><td>1 = Failure in fan 3 of node 6.</td></tr> <tr><td>7</td><td>Node 6 fan 4 failure</td><td>1 = Failure in fan 4 of node 6.</td></tr> <tr><td>8</td><td>Node 7 fan 1 failure</td><td>1 = Failure in fan 1 of node 7.</td></tr> <tr><td>9</td><td>Node 7 fan 2 failure</td><td>1 = Failure in fan 2 of node 7.</td></tr> <tr><td>10</td><td>Node 7 fan 3 failure</td><td>1 = Failure in fan 3 of node 7.</td></tr> <tr><td>11</td><td>Node 7 fan 4 failure</td><td>1 = Failure in fan 4 of node 7.</td></tr> <tr><td>12</td><td>Node 8 fan 1 failure</td><td>1 = Failure in fan 1 of node 8.</td></tr> <tr><td>13</td><td>Node 8 fan 2 failure</td><td>1 = Failure in fan 2 of node 8.</td></tr> <tr><td>14</td><td>Node 8 fan 3 failure</td><td>1 = Failure in fan 3 of node 8.</td></tr> <tr><td>15</td><td>Node 8 fan 4 failure</td><td>1 = Failure in fan 4 of node 8.</td></tr> </tbody> </table>				Bit	Name	Description	0	Node 5 fan 1 failure	1 = Failure in fan 1 of node 5.	1	Node 5 fan 2 failure	1 = Failure in fan 2 of node 5.	2	Node 5 fan 3 failure	1 = Failure in fan 3 of node 5.	3	Node 5 fan 4 failure	1 = Failure in fan 4 of node 5.	4	Node 6 fan 1 failure	1 = Failure in fan 1 of node 6.	5	Node 6 fan 2 failure	1 = Failure in fan 2 of node 6.	6	Node 6 fan 3 failure	1 = Failure in fan 3 of node 6.	7	Node 6 fan 4 failure	1 = Failure in fan 4 of node 6.	8	Node 7 fan 1 failure	1 = Failure in fan 1 of node 7.	9	Node 7 fan 2 failure	1 = Failure in fan 2 of node 7.	10	Node 7 fan 3 failure	1 = Failure in fan 3 of node 7.	11	Node 7 fan 4 failure	1 = Failure in fan 4 of node 7.	12	Node 8 fan 1 failure	1 = Failure in fan 1 of node 8.	13	Node 8 fan 2 failure	1 = Failure in fan 2 of node 8.	14	Node 8 fan 3 failure	1 = Failure in fan 3 of node 8.	15	Node 8 fan 4 failure	1 = Failure in fan 4 of node 8.
Bit	Name	Description																																																				
0	Node 5 fan 1 failure	1 = Failure in fan 1 of node 5.																																																				
1	Node 5 fan 2 failure	1 = Failure in fan 2 of node 5.																																																				
2	Node 5 fan 3 failure	1 = Failure in fan 3 of node 5.																																																				
3	Node 5 fan 4 failure	1 = Failure in fan 4 of node 5.																																																				
4	Node 6 fan 1 failure	1 = Failure in fan 1 of node 6.																																																				
5	Node 6 fan 2 failure	1 = Failure in fan 2 of node 6.																																																				
6	Node 6 fan 3 failure	1 = Failure in fan 3 of node 6.																																																				
7	Node 6 fan 4 failure	1 = Failure in fan 4 of node 6.																																																				
8	Node 7 fan 1 failure	1 = Failure in fan 1 of node 7.																																																				
9	Node 7 fan 2 failure	1 = Failure in fan 2 of node 7.																																																				
10	Node 7 fan 3 failure	1 = Failure in fan 3 of node 7.																																																				
11	Node 7 fan 4 failure	1 = Failure in fan 4 of node 7.																																																				
12	Node 8 fan 1 failure	1 = Failure in fan 1 of node 8.																																																				
13	Node 8 fan 2 failure	1 = Failure in fan 2 of node 8.																																																				
14	Node 8 fan 3 failure	1 = Failure in fan 3 of node 8.																																																				
15	Node 8 fan 4 failure	1 = Failure in fan 4 of node 8.																																																				
0000h...FFFFh		Fans failed in nodes 5...8.	1 = 1																																																			

No.	Name/Value	Description	Def/FbEq16																																																			
206.32	<i>Fan supervision status 9-12</i>	Shows statuses of fans in nodes 9...12.	0000h																																																			
		<table border="1"> <thead> <tr> <th>Bit</th> <th>Name</th> <th>Description</th> </tr> </thead> <tbody> <tr><td>0</td><td>Node 9 fan 1 failure</td><td>1 = Failure in fan 1 of node 9.</td></tr> <tr><td>1</td><td>Node 9 fan 2 failure</td><td>1 = Failure in fan 2 of node 9.</td></tr> <tr><td>2</td><td>Node 9 fan 3 failure</td><td>1 = Failure in fan 3 of node 9.</td></tr> <tr><td>3</td><td>Node 9 fan 4 failure</td><td>1 = Failure in fan 4 of node 9.</td></tr> <tr><td>4</td><td>Node 10 fan 1 failure</td><td>1 = Failure in fan 1 of node 10.</td></tr> <tr><td>5</td><td>Node 10 fan 2 failure</td><td>1 = Failure in fan 2 of node 10.</td></tr> <tr><td>6</td><td>Node 10 fan 3 failure</td><td>1 = Failure in fan 3 of node 10.</td></tr> <tr><td>7</td><td>Node 10 fan 4 failure</td><td>1 = Failure in fan 4 of node 10.</td></tr> <tr><td>8</td><td>Node 11 fan 1 failure</td><td>1 = Failure in fan 1 of node 11.</td></tr> <tr><td>9</td><td>Node 11 fan 2 failure</td><td>1 = Failure in fan 2 of node 11.</td></tr> <tr><td>10</td><td>Node 11 fan 3 failure</td><td>1 = Failure in fan 3 of node 11.</td></tr> <tr><td>11</td><td>Node 11 fan 4 failure</td><td>1 = Failure in fan 4 of node 11.</td></tr> <tr><td>12</td><td>Node 12 fan 1 failure</td><td>1 = Failure in fan 1 of node 12.</td></tr> <tr><td>13</td><td>Node 12 fan 2 failure</td><td>1 = Failure in fan 2 of node 12.</td></tr> <tr><td>14</td><td>Node 12 fan 3 failure</td><td>1 = Failure in fan 3 of node 12.</td></tr> <tr><td>15</td><td>Node 12 fan 4 failure</td><td>1 = Failure in fan 4 of node 12.</td></tr> </tbody> </table>	Bit	Name	Description	0	Node 9 fan 1 failure	1 = Failure in fan 1 of node 9.	1	Node 9 fan 2 failure	1 = Failure in fan 2 of node 9.	2	Node 9 fan 3 failure	1 = Failure in fan 3 of node 9.	3	Node 9 fan 4 failure	1 = Failure in fan 4 of node 9.	4	Node 10 fan 1 failure	1 = Failure in fan 1 of node 10.	5	Node 10 fan 2 failure	1 = Failure in fan 2 of node 10.	6	Node 10 fan 3 failure	1 = Failure in fan 3 of node 10.	7	Node 10 fan 4 failure	1 = Failure in fan 4 of node 10.	8	Node 11 fan 1 failure	1 = Failure in fan 1 of node 11.	9	Node 11 fan 2 failure	1 = Failure in fan 2 of node 11.	10	Node 11 fan 3 failure	1 = Failure in fan 3 of node 11.	11	Node 11 fan 4 failure	1 = Failure in fan 4 of node 11.	12	Node 12 fan 1 failure	1 = Failure in fan 1 of node 12.	13	Node 12 fan 2 failure	1 = Failure in fan 2 of node 12.	14	Node 12 fan 3 failure	1 = Failure in fan 3 of node 12.	15	Node 12 fan 4 failure	1 = Failure in fan 4 of node 12.	
Bit	Name	Description																																																				
0	Node 9 fan 1 failure	1 = Failure in fan 1 of node 9.																																																				
1	Node 9 fan 2 failure	1 = Failure in fan 2 of node 9.																																																				
2	Node 9 fan 3 failure	1 = Failure in fan 3 of node 9.																																																				
3	Node 9 fan 4 failure	1 = Failure in fan 4 of node 9.																																																				
4	Node 10 fan 1 failure	1 = Failure in fan 1 of node 10.																																																				
5	Node 10 fan 2 failure	1 = Failure in fan 2 of node 10.																																																				
6	Node 10 fan 3 failure	1 = Failure in fan 3 of node 10.																																																				
7	Node 10 fan 4 failure	1 = Failure in fan 4 of node 10.																																																				
8	Node 11 fan 1 failure	1 = Failure in fan 1 of node 11.																																																				
9	Node 11 fan 2 failure	1 = Failure in fan 2 of node 11.																																																				
10	Node 11 fan 3 failure	1 = Failure in fan 3 of node 11.																																																				
11	Node 11 fan 4 failure	1 = Failure in fan 4 of node 11.																																																				
12	Node 12 fan 1 failure	1 = Failure in fan 1 of node 12.																																																				
13	Node 12 fan 2 failure	1 = Failure in fan 2 of node 12.																																																				
14	Node 12 fan 3 failure	1 = Failure in fan 3 of node 12.																																																				
15	Node 12 fan 4 failure	1 = Failure in fan 4 of node 12.																																																				
	0000h...FFFFh	Fans failed in nodes 9...12.	1 = 1																																																			
206.33	<i>Fan supervision status 13-16</i>	Shows statuses of fans in nodes 13...16.	0000h																																																			
		<table border="1"> <thead> <tr> <th>Bit</th> <th>Name</th> <th>Description</th> </tr> </thead> <tbody> <tr><td>0</td><td>Node 13 fan 1 failure</td><td>1 = Failure in fan 1 of node 13.</td></tr> <tr><td>1</td><td>Node 13 fan 2 failure</td><td>1 = Failure in fan 2 of node 13.</td></tr> <tr><td>2</td><td>Node 13 fan 3 failure</td><td>1 = Failure in fan 3 of node 13.</td></tr> <tr><td>3</td><td>Node 13 fan 4 failure</td><td>1 = Failure in fan 4 of node 13.</td></tr> <tr><td>4</td><td>Node 14 fan 1 failure</td><td>1 = Failure in fan 1 of node 14.</td></tr> <tr><td>5</td><td>Node 14 fan 2 failure</td><td>1 = Failure in fan 2 of node 14.</td></tr> <tr><td>6</td><td>Node 14 fan 3 failure</td><td>1 = Failure in fan 3 of node 14.</td></tr> <tr><td>7</td><td>Node 14 fan 4 failure</td><td>1 = Failure in fan 4 of node 14.</td></tr> <tr><td>8</td><td>Node 15 fan 1 failure</td><td>1 = Failure in fan 1 of node 15.</td></tr> <tr><td>9</td><td>Node 15 fan 2 failure</td><td>1 = Failure in fan 2 of node 15.</td></tr> <tr><td>10</td><td>Node 15 fan 3 failure</td><td>1 = Failure in fan 3 of node 15.</td></tr> <tr><td>11</td><td>Node 15 fan 4 failure</td><td>1 = Failure in fan 4 of node 15.</td></tr> <tr><td>12</td><td>Node 16 fan 1 failure</td><td>1 = Failure in fan 1 of node 16.</td></tr> <tr><td>13</td><td>Node 16 fan 2 failure</td><td>1 = Failure in fan 2 of node 16.</td></tr> <tr><td>14</td><td>Node 16 fan 3 failure</td><td>1 = Failure in fan 3 of node 16.</td></tr> <tr><td>15</td><td>Node 16 fan 4 failure</td><td>1 = Failure in fan 4 of node 16.</td></tr> </tbody> </table>	Bit	Name	Description	0	Node 13 fan 1 failure	1 = Failure in fan 1 of node 13.	1	Node 13 fan 2 failure	1 = Failure in fan 2 of node 13.	2	Node 13 fan 3 failure	1 = Failure in fan 3 of node 13.	3	Node 13 fan 4 failure	1 = Failure in fan 4 of node 13.	4	Node 14 fan 1 failure	1 = Failure in fan 1 of node 14.	5	Node 14 fan 2 failure	1 = Failure in fan 2 of node 14.	6	Node 14 fan 3 failure	1 = Failure in fan 3 of node 14.	7	Node 14 fan 4 failure	1 = Failure in fan 4 of node 14.	8	Node 15 fan 1 failure	1 = Failure in fan 1 of node 15.	9	Node 15 fan 2 failure	1 = Failure in fan 2 of node 15.	10	Node 15 fan 3 failure	1 = Failure in fan 3 of node 15.	11	Node 15 fan 4 failure	1 = Failure in fan 4 of node 15.	12	Node 16 fan 1 failure	1 = Failure in fan 1 of node 16.	13	Node 16 fan 2 failure	1 = Failure in fan 2 of node 16.	14	Node 16 fan 3 failure	1 = Failure in fan 3 of node 16.	15	Node 16 fan 4 failure	1 = Failure in fan 4 of node 16.	
Bit	Name	Description																																																				
0	Node 13 fan 1 failure	1 = Failure in fan 1 of node 13.																																																				
1	Node 13 fan 2 failure	1 = Failure in fan 2 of node 13.																																																				
2	Node 13 fan 3 failure	1 = Failure in fan 3 of node 13.																																																				
3	Node 13 fan 4 failure	1 = Failure in fan 4 of node 13.																																																				
4	Node 14 fan 1 failure	1 = Failure in fan 1 of node 14.																																																				
5	Node 14 fan 2 failure	1 = Failure in fan 2 of node 14.																																																				
6	Node 14 fan 3 failure	1 = Failure in fan 3 of node 14.																																																				
7	Node 14 fan 4 failure	1 = Failure in fan 4 of node 14.																																																				
8	Node 15 fan 1 failure	1 = Failure in fan 1 of node 15.																																																				
9	Node 15 fan 2 failure	1 = Failure in fan 2 of node 15.																																																				
10	Node 15 fan 3 failure	1 = Failure in fan 3 of node 15.																																																				
11	Node 15 fan 4 failure	1 = Failure in fan 4 of node 15.																																																				
12	Node 16 fan 1 failure	1 = Failure in fan 1 of node 16.																																																				
13	Node 16 fan 2 failure	1 = Failure in fan 2 of node 16.																																																				
14	Node 16 fan 3 failure	1 = Failure in fan 3 of node 16.																																																				
15	Node 16 fan 4 failure	1 = Failure in fan 4 of node 16.																																																				
	0000h...FFFFh	Fans failed in nodes 13...16.	1 = 1																																																			

36 Parameters

No.	Name/Value	Description	Def/FbEq16																																																			
206.40	<i>MCB monitoring status</i>	Indicates the status of miniature circuit breaker input (digital input DI5) of each I/O node.	0000h																																																			
<table border="1"> <thead> <tr> <th>Bit</th> <th>Name</th> <th>Description</th> </tr> </thead> <tbody> <tr><td>0</td><td>I/O Node 1</td><td>Status of digital input DI5 of node 1.</td></tr> <tr><td>1</td><td>I/O Node 2</td><td>Status of digital input DI5 of node 2.</td></tr> <tr><td>2</td><td>I/O Node 3</td><td>Status of digital input DI5 of node 3.</td></tr> <tr><td>3</td><td>I/O Node 4</td><td>Status of digital input DI5 of node 4.</td></tr> <tr><td>4</td><td>I/O Node 5</td><td>Status of digital input DI5 of node 5.</td></tr> <tr><td>5</td><td>I/O Node 6</td><td>Status of digital input DI5 of node 6.</td></tr> <tr><td>6</td><td>I/O Node 7</td><td>Status of digital input DI5 of node 7.</td></tr> <tr><td>7</td><td>I/O Node 8</td><td>Status of digital input DI5 of node 8.</td></tr> <tr><td>8</td><td>I/O Node 9</td><td>Status of digital input DI5 of node 9.</td></tr> <tr><td>9</td><td>I/O Node 10</td><td>Status of digital input DI5 of node 10.</td></tr> <tr><td>10</td><td>I/O Node 11</td><td>Status of digital input DI5 of node 11.</td></tr> <tr><td>11</td><td>I/O Node 12</td><td>Status of digital input DI5 of node 12.</td></tr> <tr><td>12</td><td>I/O Node 13</td><td>Status of digital input DI5 of node 13.</td></tr> <tr><td>13</td><td>I/O Node 14</td><td>Status of digital input DI5 of node 14.</td></tr> <tr><td>14</td><td>I/O Node 15</td><td>Status of digital input DI5 of node 15.</td></tr> <tr><td>15</td><td>I/O Node 16</td><td>Status of digital input DI5 of node 16.</td></tr> </tbody> </table>				Bit	Name	Description	0	I/O Node 1	Status of digital input DI5 of node 1.	1	I/O Node 2	Status of digital input DI5 of node 2.	2	I/O Node 3	Status of digital input DI5 of node 3.	3	I/O Node 4	Status of digital input DI5 of node 4.	4	I/O Node 5	Status of digital input DI5 of node 5.	5	I/O Node 6	Status of digital input DI5 of node 6.	6	I/O Node 7	Status of digital input DI5 of node 7.	7	I/O Node 8	Status of digital input DI5 of node 8.	8	I/O Node 9	Status of digital input DI5 of node 9.	9	I/O Node 10	Status of digital input DI5 of node 10.	10	I/O Node 11	Status of digital input DI5 of node 11.	11	I/O Node 12	Status of digital input DI5 of node 12.	12	I/O Node 13	Status of digital input DI5 of node 13.	13	I/O Node 14	Status of digital input DI5 of node 14.	14	I/O Node 15	Status of digital input DI5 of node 15.	15	I/O Node 16	Status of digital input DI5 of node 16.
Bit	Name	Description																																																				
0	I/O Node 1	Status of digital input DI5 of node 1.																																																				
1	I/O Node 2	Status of digital input DI5 of node 2.																																																				
2	I/O Node 3	Status of digital input DI5 of node 3.																																																				
3	I/O Node 4	Status of digital input DI5 of node 4.																																																				
4	I/O Node 5	Status of digital input DI5 of node 5.																																																				
5	I/O Node 6	Status of digital input DI5 of node 6.																																																				
6	I/O Node 7	Status of digital input DI5 of node 7.																																																				
7	I/O Node 8	Status of digital input DI5 of node 8.																																																				
8	I/O Node 9	Status of digital input DI5 of node 9.																																																				
9	I/O Node 10	Status of digital input DI5 of node 10.																																																				
10	I/O Node 11	Status of digital input DI5 of node 11.																																																				
11	I/O Node 12	Status of digital input DI5 of node 12.																																																				
12	I/O Node 13	Status of digital input DI5 of node 13.																																																				
13	I/O Node 14	Status of digital input DI5 of node 14.																																																				
14	I/O Node 15	Status of digital input DI5 of node 15.																																																				
15	I/O Node 16	Status of digital input DI5 of node 16.																																																				
0000h...FFFFh		Statuses of miniature circuit breaker input (digital input DI5).	1 = 1																																																			
206.41	<i>Fuse monitoring status</i>	Indicates the status of fuse monitoring input (digital input DI6) of each I/O node.	0000h																																																			
<table border="1"> <thead> <tr> <th>Bit</th> <th>Name</th> <th>Description</th> </tr> </thead> <tbody> <tr><td>0</td><td>I/O Node 1</td><td>Status of digital input DI6 of node 1.</td></tr> <tr><td>1</td><td>I/O Node 2</td><td>Status of digital input DI6 of node 2.</td></tr> <tr><td>2</td><td>I/O Node 3</td><td>Status of digital input DI6 of node 3.</td></tr> <tr><td>3</td><td>I/O Node 4</td><td>Status of digital input DI6 of node 4.</td></tr> <tr><td>4</td><td>I/O Node 5</td><td>Status of digital input DI6 of node 5.</td></tr> <tr><td>5</td><td>I/O Node 6</td><td>Status of digital input DI6 of node 6.</td></tr> <tr><td>6</td><td>I/O Node 7</td><td>Status of digital input DI6 of node 7.</td></tr> <tr><td>7</td><td>I/O Node 8</td><td>Status of digital input DI6 of node 8.</td></tr> <tr><td>8</td><td>I/O Node 9</td><td>Status of digital input DI6 of node 9.</td></tr> <tr><td>9</td><td>I/O Node 10</td><td>Status of digital input DI6 of node 10.</td></tr> <tr><td>10</td><td>I/O Node 11</td><td>Status of digital input DI6 of node 11.</td></tr> <tr><td>11</td><td>I/O Node 12</td><td>Status of digital input DI6 of node 12.</td></tr> <tr><td>12</td><td>I/O Node 13</td><td>Status of digital input DI6 of node 13.</td></tr> <tr><td>13</td><td>I/O Node 14</td><td>Status of digital input DI6 of node 14.</td></tr> <tr><td>14</td><td>I/O Node 15</td><td>Status of digital input DI6 of node 15.</td></tr> <tr><td>15</td><td>I/O Node 16</td><td>Status of digital input DI6 of node 16.</td></tr> </tbody> </table>				Bit	Name	Description	0	I/O Node 1	Status of digital input DI6 of node 1.	1	I/O Node 2	Status of digital input DI6 of node 2.	2	I/O Node 3	Status of digital input DI6 of node 3.	3	I/O Node 4	Status of digital input DI6 of node 4.	4	I/O Node 5	Status of digital input DI6 of node 5.	5	I/O Node 6	Status of digital input DI6 of node 6.	6	I/O Node 7	Status of digital input DI6 of node 7.	7	I/O Node 8	Status of digital input DI6 of node 8.	8	I/O Node 9	Status of digital input DI6 of node 9.	9	I/O Node 10	Status of digital input DI6 of node 10.	10	I/O Node 11	Status of digital input DI6 of node 11.	11	I/O Node 12	Status of digital input DI6 of node 12.	12	I/O Node 13	Status of digital input DI6 of node 13.	13	I/O Node 14	Status of digital input DI6 of node 14.	14	I/O Node 15	Status of digital input DI6 of node 15.	15	I/O Node 16	Status of digital input DI6 of node 16.
Bit	Name	Description																																																				
0	I/O Node 1	Status of digital input DI6 of node 1.																																																				
1	I/O Node 2	Status of digital input DI6 of node 2.																																																				
2	I/O Node 3	Status of digital input DI6 of node 3.																																																				
3	I/O Node 4	Status of digital input DI6 of node 4.																																																				
4	I/O Node 5	Status of digital input DI6 of node 5.																																																				
5	I/O Node 6	Status of digital input DI6 of node 6.																																																				
6	I/O Node 7	Status of digital input DI6 of node 7.																																																				
7	I/O Node 8	Status of digital input DI6 of node 8.																																																				
8	I/O Node 9	Status of digital input DI6 of node 9.																																																				
9	I/O Node 10	Status of digital input DI6 of node 10.																																																				
10	I/O Node 11	Status of digital input DI6 of node 11.																																																				
11	I/O Node 12	Status of digital input DI6 of node 12.																																																				
12	I/O Node 13	Status of digital input DI6 of node 13.																																																				
13	I/O Node 14	Status of digital input DI6 of node 14.																																																				
14	I/O Node 15	Status of digital input DI6 of node 15.																																																				
15	I/O Node 16	Status of digital input DI6 of node 16.																																																				
0000h...FFFFh		Statuses of fuse monitoring input (digital input DI6).	1 = 1																																																			

No.	Name/Value	Description	Def/FbEq16																																																			
206.43	<i>CIO DI8 status</i>	Indicates the logical state of digital input DI8 of each I/O node.	0000h																																																			
		<table border="1"> <thead> <tr> <th>Bit</th> <th>Name</th> <th>Description</th> </tr> </thead> <tbody> <tr><td>0</td><td>I/O Node 1</td><td>Status of digital input DI8 of node 1.</td></tr> <tr><td>1</td><td>I/O Node 2</td><td>Status of digital input DI8 of node 2.</td></tr> <tr><td>2</td><td>I/O Node 3</td><td>Status of digital input DI8 of node 3.</td></tr> <tr><td>3</td><td>I/O Node 4</td><td>Status of digital input DI8 of node 4.</td></tr> <tr><td>4</td><td>I/O Node 5</td><td>Status of digital input DI8 of node 5.</td></tr> <tr><td>5</td><td>I/O Node 6</td><td>Status of digital input DI8 of node 6.</td></tr> <tr><td>6</td><td>I/O Node 7</td><td>Status of digital input DI8 of node 7.</td></tr> <tr><td>7</td><td>I/O Node 8</td><td>Status of digital input DI8 of node 8.</td></tr> <tr><td>8</td><td>I/O Node 9</td><td>Status of digital input DI8 of node 9.</td></tr> <tr><td>9</td><td>I/O Node 10</td><td>Status of digital input DI8 of node 10.</td></tr> <tr><td>10</td><td>I/O Node 11</td><td>Status of digital input DI8 of node 11.</td></tr> <tr><td>11</td><td>I/O Node 12</td><td>Status of digital input DI8 of node 12.</td></tr> <tr><td>12</td><td>I/O Node 13</td><td>Status of digital input DI8 of node 13.</td></tr> <tr><td>13</td><td>I/O Node 14</td><td>Status of digital input DI8 of node 14.</td></tr> <tr><td>14</td><td>I/O Node 15</td><td>Status of digital input DI8 of node 15.</td></tr> <tr><td>15</td><td>I/O Node 16</td><td>Status of digital input DI8 of node 16.</td></tr> </tbody> </table>	Bit	Name	Description	0	I/O Node 1	Status of digital input DI8 of node 1.	1	I/O Node 2	Status of digital input DI8 of node 2.	2	I/O Node 3	Status of digital input DI8 of node 3.	3	I/O Node 4	Status of digital input DI8 of node 4.	4	I/O Node 5	Status of digital input DI8 of node 5.	5	I/O Node 6	Status of digital input DI8 of node 6.	6	I/O Node 7	Status of digital input DI8 of node 7.	7	I/O Node 8	Status of digital input DI8 of node 8.	8	I/O Node 9	Status of digital input DI8 of node 9.	9	I/O Node 10	Status of digital input DI8 of node 10.	10	I/O Node 11	Status of digital input DI8 of node 11.	11	I/O Node 12	Status of digital input DI8 of node 12.	12	I/O Node 13	Status of digital input DI8 of node 13.	13	I/O Node 14	Status of digital input DI8 of node 14.	14	I/O Node 15	Status of digital input DI8 of node 15.	15	I/O Node 16	Status of digital input DI8 of node 16.	
Bit	Name	Description																																																				
0	I/O Node 1	Status of digital input DI8 of node 1.																																																				
1	I/O Node 2	Status of digital input DI8 of node 2.																																																				
2	I/O Node 3	Status of digital input DI8 of node 3.																																																				
3	I/O Node 4	Status of digital input DI8 of node 4.																																																				
4	I/O Node 5	Status of digital input DI8 of node 5.																																																				
5	I/O Node 6	Status of digital input DI8 of node 6.																																																				
6	I/O Node 7	Status of digital input DI8 of node 7.																																																				
7	I/O Node 8	Status of digital input DI8 of node 8.																																																				
8	I/O Node 9	Status of digital input DI8 of node 9.																																																				
9	I/O Node 10	Status of digital input DI8 of node 10.																																																				
10	I/O Node 11	Status of digital input DI8 of node 11.																																																				
11	I/O Node 12	Status of digital input DI8 of node 12.																																																				
12	I/O Node 13	Status of digital input DI8 of node 13.																																																				
13	I/O Node 14	Status of digital input DI8 of node 14.																																																				
14	I/O Node 15	Status of digital input DI8 of node 15.																																																				
15	I/O Node 16	Status of digital input DI8 of node 16.																																																				
	0000h...FFFFh	Statuses of digital input DI8.	1 = 1																																																			
206.50	<i>MCB monitoring action</i>	Selects the action to be taken when miniature circuit breaker monitoring is triggered.	<i>Warning</i>																																																			
	No	No action taken.	0																																																			
	Warning	The supply unit generates an <i>AE94 CIO MCB monitoring</i> warning.	1																																																			
	Fault	The supply unit trips on <i>8E14 CIO MCB monitoring</i> .	2																																																			
206.51	<i>Fuse monitoring action</i>	Selects the action to be taken when fuse monitoring is triggered.	<i>Warning</i>																																																			
	No	No action taken.	0																																																			
	Warning	The supply unit generates an <i>AE95 CIO fuse monitoring</i> warning.	1																																																			
	Fault	The supply unit trips on <i>8E15 CIO fuse monitoring</i> .	2																																																			
206.53	<i>CIO DI8 monitoring action</i>	Selects the action to be taken when digital input DI8 monitoring of the CIO-01 module is triggered.	<i>No</i>																																																			
	No	No action taken.	0																																																			
	Warning	The supply unit generates an <i>AE97 CIO DI8 monitoring</i> warning.	1																																																			
	Fault	The supply unit trips on <i>8E17 CIO DI8 monitoring</i> .	2																																																			
<i>207 I/O bus service</i>		Service request parameters for selected node.																																																				
207.01	<i>Node ID number</i>	Selects the node. Note: All the parameters in this parameter group concern the selected node only.	1																																																			
	1...99	Node ID number.	1 = 1																																																			
207.02	<i>Fan reset selection</i>	Selects the fan(s) for the operation selected with parameter <i>207.03 Command selection</i> .	0000h																																																			
		<table border="1"> <thead> <tr> <th>Bit</th> <th>Name</th> <th>Description</th> </tr> </thead> <tbody> <tr><td>0</td><td>Fan 1</td><td>1 = Fan 1 in the selected node.</td></tr> <tr><td>1</td><td>Fan 2</td><td>1 = Fan 2 in the selected node.</td></tr> <tr><td>2</td><td>Fan 3</td><td>1 = Fan 3 in the selected node.</td></tr> <tr><td>3</td><td>Fan 4</td><td>1 = Fan 4 in the selected node.</td></tr> <tr><td>4...15</td><td>Reserved.</td><td></td></tr> </tbody> </table>	Bit	Name	Description	0	Fan 1	1 = Fan 1 in the selected node.	1	Fan 2	1 = Fan 2 in the selected node.	2	Fan 3	1 = Fan 3 in the selected node.	3	Fan 4	1 = Fan 4 in the selected node.	4...15	Reserved.																																			
Bit	Name	Description																																																				
0	Fan 1	1 = Fan 1 in the selected node.																																																				
1	Fan 2	1 = Fan 2 in the selected node.																																																				
2	Fan 3	1 = Fan 3 in the selected node.																																																				
3	Fan 4	1 = Fan 4 in the selected node.																																																				
4...15	Reserved.																																																					

38 Parameters

No.	Name/Value	Description	Def/FbEq16
	0000h...FFFFh	Fan.	1 = 1
207.03	Command selection	Selects the operation for the fan(s) selected with parameter 207.02 Fan reset selection .	<i>None</i>
	None	None.	0
	Read fan on-time	Shows the operating time (in hours) of the fan(s) in parameters 207.11...207.14 .	1
	Reset fan on-time	Resets the on-time counter of the fan(s).	2
	Reset fan ID run	Resets the last identification run of the fan(s).	3
	Reset fan data	Resets the on-time counter and identification run data shown by parameters 207.11...207.14 . Can be used if a fan is replaced with a new one.	4
	Read fan speeds	Shows the speeds (in Hz) of the fan(s) in parameters 207.11...207.14 .	5
207.10	Service request trigger	Performs the operation selected with parameter 207.03 Command selection .	<i>Done</i>
	Done	Operation done or not requested.	0
	Refresh	Performs the operation.	1
207.11	Fan 1 data	Shows the output of the operation selected with parameter 207.03 Command selection for fan 1.	-
	0.00... 2147483648.00	Fan 1 data.	100 = 1
207.12	Fan 2 data	Shows the output of the operation selected with parameter 207.03 Command selection for fan 2.	-
	0.00... 2147483648.00	Fan 2 data.	100 = 1
207.13	Fan 3 data	Shows the output of the operation selected with parameter 207.03 Command selection for fan 3.	-
	0.00... 2147483648.00	Fan 3 data.	100 = 1
207.14	Fan 4 data	Shows the output of the operation selected with parameter 207.03 Command selection for fan 4.	-
	0.00... 2147483648.00	Fan 4 data.	100 = 1
208 I/O bus diagnostics		Diagnostic counters of the distributed I/O bus.	
208.01	Transmitted packets	Displays a count of messages (ie. packets) transmitted by the master.	-
	0...4294967295	Number of messages transmitted by the master.	1 = 1
208.02	Received packets	Displays a count of messages (ie. packets) sent to the master.	-
	0...4294967295	Number of messages received by the master.	1 = 1
208.03	CRC errors	Displays a count of packets with a CRC error. An increasing count indicates errors in the check sum.	-
	0...4294967295	Number of CRC errors.	1 = 1
208.04	UART errors	Displays a count of character errors. An increasing count indicates a configuration problem on the bus.	-
	0...4294967295	Number of UART errors.	1 = 1
208.05	Modbus errors	Displays a count of Modbus® errors. An increasing count indicates errors on the Modbus protocol.	-
	0...4294967295	Number of Modbus errors.	1 = 1

No.	Name/Value	Description	Def/FbEq16
208.06	<i>Timeouts</i>	Displays a sum of timeouts in all of the nodes (see parameters 208.11...208.26). A timeout is a request-response cycle in the I/O bus, where the bus master sends a request but does not get a correctly-formed response message in return within the time window reserved for the cycle.	-
	0...4294967295	Number of timeouts.	1 = 1
208.11	<i>Node 1 timeouts</i>	Displays a count of timeouts in node 1.	-
	0...4294967295	Number of timeouts in node 1.	1 = 1
208.12	<i>Node 2 timeouts</i>	Displays a count of timeouts in node 2.	-
	0...4294967295	Number of timeouts in node 2.	1 = 1
208.13	<i>Node 3 timeouts</i>	Displays a count of timeouts in node 3.	-
	0...4294967295	Number of timeouts in node 3.	1 = 1
208.14	<i>Node 4 timeouts</i>	Displays a count of timeouts in node 4.	-
	0...4294967295	Number of timeouts in node 4.	1 = 1
208.15	<i>Node 5 timeouts</i>	Displays a count of timeouts in node 5.	-
	0...4294967295	Number of timeouts in node 5.	1 = 1
208.16	<i>Node 6 timeouts</i>	Displays a count of timeouts in node 6.	-
	0...4294967295	Number of timeouts in node 6.	1 = 1
208.17	<i>Node 7 timeouts</i>	Displays a count of timeouts in node 7.	-
	0...4294967295	Number of timeouts in node 7.	1 = 1
208.18	<i>Node 8 timeouts</i>	Displays a count of timeouts in node 8.	-
	0...4294967295	Number of timeouts in node 8.	1 = 1
208.19	<i>Node 9 timeouts</i>	Displays a count of timeouts in node 9.	-
	0...4294967295	Number of timeouts in node 9.	1 = 1
208.20	<i>Node 10 timeouts</i>	Displays a count of timeouts in node 10.	-
	0...4294967295	Number of timeouts in node 10.	1 = 1
208.21	<i>Node 11 timeouts</i>	Displays a count of timeouts in node 11.	-
	0...4294967295	Number of timeouts in node 11.	1 = 1
208.22	<i>Node 12 timeouts</i>	Displays a count of timeouts in node 12.	-
	0...4294967295	Number of timeouts in node 12.	1 = 1
208.23	<i>Node 13 timeouts</i>	Displays a count of timeouts in node 13.	-
	0...4294967295	Number of timeouts in node 13.	1 = 1
208.24	<i>Node 14 timeouts</i>	Displays a count of timeouts in node 14.	-
	0...4294967295	Number of timeouts in node 14.	1 = 1
208.25	<i>Node 15 timeouts</i>	Displays a count of timeouts in node 15.	-
	0...4294967295	Number of timeouts in node 15.	1 = 1
208.26	<i>Node 16 timeouts</i>	Displays a count of timeouts in node 16.	-
	0...4294967295	Number of timeouts in node 16.	1 = 1
208.80	<i>Reset diagnostics counters</i>	Resets error and timeout counters.	<i>Done</i>
	Done	Reset completed or not requested.	0
	Refresh	Resets error and timeout counters.	1
<i>209 I/O bus fan identification</i>		Results of the identification run of the fan.	
209.01	<i>Node 1 fan 1 pulse freq</i>	Displays the result of the identification run for fan 1 of node 1.	-
	0.0...5000.0 Hz	Result of the identification run for fan 1 of node 1.	1 = 1 Hz
...

40 Parameters

No.	Name/Value	Description	Def/FbEq16
209.04	<i>Node 1 fan 4 pulse freq</i>	Displays the result of the identification run for fan 4 of node 1.	-
	0.0...5000.0 Hz	Result of the identification run for fan 4 of node 1.	1 = 1 Hz
209.05	<i>Node 2 fan 1 pulse freq</i>	Displays the result of the identification run for fan 1 of node 2.	-
	0.0...5000.0 Hz	Result of the identification run for fan 1 of node 2.	1 = 1 Hz
...
209.08	<i>Node 2 fan 4 pulse freq</i>	Displays the result of the identification run for fan 4 of node 2.	-
	0.0...5000.0 Hz	Result of the identification run for fan 4 of node 2.	1 = 1 Hz
209.09	<i>Node 3 fan 1 pulse freq</i>	Displays the result of the identification run for fan 1 of node 3.	-
	0.0...5000.0 Hz	Result of the identification run for fan 1 of node 3.	1 = 1 Hz
...
209.12	<i>Node 3 fan 4 pulse freq</i>	Displays the result of the identification run for fan 4 of node 3.	-
	0.0...5000.0 Hz	Result of the identification run for fan 4 of node 3.	1 = 1 Hz
209.13	<i>Node 4 fan 1 pulse freq</i>	Displays the result of the identification run for fan 1 of node 4.	-
	0.0...5000.0 Hz	Result of the identification run for fan 1 of node 4.	1 = 1 Hz
...
209.16	<i>Node 4 fan 4 pulse freq</i>	Displays the result of the identification run for fan 4 of node 4.	-
	0.0...5000.0 Hz	Result of the identification run for fan 4 of node 4.	1 = 1 Hz
209.17	<i>Node 5 fan 1 pulse freq</i>	Displays the result of the identification run for fan 1 of node 5.	-
	0.0...5000.0 Hz	Result of the identification run for fan 1 of node 5.	1 = 1 Hz
...
209.20	<i>Node 5 fan 4 pulse freq</i>	Displays the result of the identification run for fan 4 of node 5.	-
	0.0...5000.0 Hz	Result of the identification run for fan 4 of node 5.	1 = 1 Hz
209.21	<i>Node 6 fan 1 pulse freq</i>	Displays the result of the identification run for fan 1 of node 6.	-
	0.0...5000.0 Hz	Result of the identification run for fan 1 of node 6.	1 = 1 Hz
...
209.24	<i>Node 6 fan 4 pulse freq</i>	Displays the result of the identification run for fan 4 of node 6.	-
	0.0...5000.0 Hz	Result of the identification run for fan 4 of node 6.	1 = 1 Hz
209.25	<i>Node 7 fan 1 pulse freq</i>	Displays the result of the identification run for fan 1 of node 7.	-
	0.0...5000.0 Hz	Result of the identification run for fan 1 of node 7.	1 = 1 Hz
...
209.28	<i>Node 7 fan 4 pulse freq</i>	Displays the result of the identification run for fan 4 of node 7.	-
	0.0...5000.0 Hz	Result of the identification run for fan 4 of node 7.	1 = 1 Hz
209.29	<i>Node 8 fan 1 pulse freq</i>	Displays the result of the identification run for fan 1 of node 8.	-
	0.0...5000.0 Hz	Result of the identification run for fan 1 of node 8.	1 = 1 Hz
...
209.32	<i>Node 8 fan 4 pulse freq</i>	Displays the result of the identification run for fan 4 of node 8.	-
	0.0...5000.0 Hz	Result of the identification run for fan 4 of node 8.	1 = 1 Hz

No.	Name/Value	Description	Def/FbEq16
209.33	<i>Node 9 fan 1 pulse freq</i>	Displays the result of the identification run for fan 1 of node 9.	-
	0.0...5000.0 Hz	Result of the identification run for fan 1 of node 9.	1 = 1 Hz
...
209.36	<i>Node 9 fan 4 pulse freq</i>	Displays the result of the identification run for fan 4 of node 9.	-
	0.0...5000.0 Hz	Result of the identification run for fan 4 of node 9.	1 = 1 Hz
209.37	<i>Node 10 fan 1 pulse freq</i>	Displays the result of the identification run for fan 1 of node 10.	-
	0.0...5000.0 Hz	Result of the identification run for fan 1 of node 10.	1 = 1 Hz
...
209.40	<i>Node 10 fan 4 pulse freq</i>	Displays the result of the identification run for fan 4 of node 10.	-
	0.0...5000.0 Hz	Result of the identification run for fan 4 of node 10.	1 = 1 Hz
209.41	<i>Node 11 fan 1 pulse freq</i>	Displays the result of the identification run for fan 1 of node 11.	-
	0.0...5000.0 Hz	Result of the identification run for fan 1 of node 11.	1 = 1 Hz
...
209.44	<i>Node 11 fan 4 pulse freq</i>	Displays the result of the identification run for fan 4 of node 11.	-
	0.0...5000.0 Hz	Result of the identification run for fan 4 of node 11.	1 = 1 Hz
209.45	<i>Node 12 fan 1 pulse freq</i>	Displays the result of the identification run for fan 1 of node 12.	-
	0.0...5000.0 Hz	Result of the identification run for fan 1 of node 12.	1 = 1 Hz
...
209.48	<i>Node 12 fan 4 pulse freq</i>	Displays the result of the identification run for fan 4 of node 12.	-
	0.0...5000.0 Hz	Result of the identification run for fan 4 of node 12.	1 = 1 Hz
209.49	<i>Node 13 fan 1 pulse freq</i>	Displays the result of the identification run for fan 1 of node 13.	-
	0.0...5000.0 Hz	Result of the identification run for fan 1 of node 13.	1 = 1 Hz
...
209.52	<i>Node 13 fan 4 pulse freq</i>	Displays the result of the identification run for fan 4 of node 13.	-
	0.0...5000.0 Hz	Result of the identification run for fan 4 of node 13.	1 = 1 Hz
209.53	<i>Node 14 fan 1 pulse freq</i>	Displays the result of the identification run for fan 1 of node 14.	-
	0.0...5000.0 Hz	Result of the identification run for fan 1 of node 14.	1 = 1 Hz
...
209.56	<i>Node 14 fan 4 pulse freq</i>	Displays the result of the identification run for fan 4 of node 14.	-
	0.0...5000.0 Hz	Result of the identification run for fan 4 of node 14.	1 = 1 Hz
209.57	<i>Node 15 fan 1 pulse freq</i>	Displays the result of the identification run for fan 1 of node 15.	-
	0.0...5000.0 Hz	Result of the identification run for fan 1 of node 15.	1 = 1 Hz
...
209.60	<i>Node 15 fan 4 pulse freq</i>	Displays the result of the identification run for fan 4 of node 15.	-
	0.0...5000.0 Hz	Result of the identification run for fan 4 of node 15.	1 = 1 Hz
209.61	<i>Node 16 fan 1 pulse freq</i>	Displays the result of the identification run for fan 1 of node 16.	-
	0.0...5000.0 Hz	Result of the identification run for fan 1 of node 16.	1 = 1 Hz

42 Parameters

No.	Name/Value	Description	Def/FbEq16
...
209.64	<i>Node 16 fan 4 pulse freq</i>	Displays the result of the identification run for fan 4 of node 16.	-
	0.0...5000.0 Hz	Result of the identification run for fan 4 of node 16.	1 = 1 Hz

9

Additional parameter data

Contents of this chapter

This chapter lists the parameters with some additional data. For parameter descriptions, see chapter [Parameters](#) (page 29).

Terms and abbreviations

Term	Definition
Actual signal	Signal measured or calculated by the supply unit. Usually can only be monitored but not adjusted; some counter-type signals can however be reset.
Analog src	The parameter can be set to the value of another parameter by choosing “Other”, and selecting the source parameter from a list. In addition to the “Other” selection, the parameter may offer other pre-selected settings.
Binary src	The value of the parameter can be taken from a specific bit in another parameter value (“Other”). Sometimes the value can be fixed to 0 (false) or 1 (true). In addition, the parameter may offer other pre-selected settings.
Data	Data parameter.
FbEq32	32-bit fieldbus equivalent: The scaling between the integer used in communication and the value shown on the panel when a 32-bit value is selected for transmission to an external system. The corresponding 16-bit scalings are listed in chapter Parameters (page 29).
List	Selection list.
No.	Parameter number.
PB	Packed Boolean (bit list).
Real	Real number.

Term	Definition
Type	Parameter type. See Analog src , Binary src , List , PB , Real .

Fieldbus addresses

Refer to the *User's manual* of the fieldbus adapter.

Parameter groups 206...209

No.	Name	Type	Range	Unit	FbEq32
206 I/O bus configuration					
206.01	I/O bus enable	<i>List</i>	0...1	-	1 = 1
206.06	Fan speed warning limit	<i>Real</i>	0.0...100.0	%	10 = 1%
206.07	Fan speed fault limit	<i>Real</i>	0.0...100.0	%	10 = 1%
206.08	Fan on-time warning limit	<i>Real</i>	0...596523	h	1 = 1 h
206.09	Communication loss time	<i>Real</i>	0...600	s	1 = 1 s
206.18	Node activation	<i>PB</i>	0000h...FFFFh	-	1 = 1
206.20	Fan activation nodes 1-4	<i>PB</i>	0000h...FFFFh	-	1 = 1
206.21	Fan activation nodes 5-8	<i>PB</i>	0000h...FFFFh	-	1 = 1
206.22	Fan activation nodes 9-12	<i>PB</i>	0000h...FFFFh	-	1 = 1
206.23	Fan activation nodes 13-16	<i>PB</i>	0000h...FFFFh	-	1 = 1
206.30	Fan supervision status 1-4	<i>PB</i>	0000h...FFFFh	-	1 = 1
206.31	Fan supervision status 5-8	<i>PB</i>	0000h...FFFFh	-	1 = 1
206.32	Fan supervision status 9-12	<i>PB</i>	0000h...FFFFh	-	1 = 1
206.33	Fan supervision status 13-16	<i>PB</i>	0000h...FFFFh	-	1 = 1
206.40	MCB monitoring status	<i>PB</i>	0000h...FFFFh	-	1 = 1
206.41	Fuse monitoring status	<i>PB</i>	0000h...FFFFh	-	1 = 1
206.43	CIO DI8 status	<i>PB</i>	0000h...FFFFh	-	1 = 1
206.50	MCB monitoring action	<i>List</i>	0...2	-	1 = 1
206.51	Fuse monitoring action	<i>List</i>	0...2	-	1 = 1
206.53	CIO DI8 monitoring action	<i>List</i>	0...2	-	1 = 1
207 I/O bus service					
207.01	Node ID number	<i>Real</i>	1...99	-	1 = 1
207.02	Fan reset selection	<i>PB</i>	0000h...FFFFh	-	1 = 1
207.03	Command selection	<i>List</i>	0...5	-	1 = 1
207.10	Service request trigger	<i>List</i>	0...1	-	1 = 1
207.11	Fan 1 data	<i>Real</i>	0.00...2147483648.00	-	100 = 1
207.12	Fan 2 data	<i>Real</i>	0.00...2147483648.00	-	100 = 1
207.13	Fan 3 data	<i>Real</i>	0.00...2147483648.00	-	100 = 1
207.14	Fan 4 data	<i>Real</i>	0.00...2147483648.00	-	100 = 1
208 I/O bus diagnostics					
208.01	Transmitted packets	<i>Real</i>	0...4294967295	-	1 = 1
208.02	Received packets	<i>Real</i>	0...4294967295	-	1 = 1
208.03	CRC errors	<i>Real</i>	0...4294967295	-	1 = 1
208.04	UART errors	<i>Real</i>	0...4294967295	-	1 = 1
208.05	Modbus errors	<i>Real</i>	0...4294967295	-	1 = 1
208.06	Timeouts	<i>Real</i>	0...4294967295	-	1 = 1
208.11	Node 1 timeouts	<i>Real</i>	0...4294967295	-	1 = 1
208.12	Node 2 timeouts	<i>Real</i>	0...4294967295	-	1 = 1
208.13	Node 3 timeouts	<i>Real</i>	0...4294967295	-	1 = 1
208.14	Node 4 timeouts	<i>Real</i>	0...4294967295	-	1 = 1
208.15	Node 5 timeouts	<i>Real</i>	0...4294967295	-	1 = 1
208.16	Node 6 timeouts	<i>Real</i>	0...4294967295	-	1 = 1
208.17	Node 7 timeouts	<i>Real</i>	0...4294967295	-	1 = 1
208.18	Node 8 timeouts	<i>Real</i>	0...4294967295	-	1 = 1
208.19	Node 9 timeouts	<i>Real</i>	0...4294967295	-	1 = 1
208.20	Node 10 timeouts	<i>Real</i>	0...4294967295	-	1 = 1

46 Additional parameter data

No.	Name	Type	Range	Unit	FbEq32
208.21	Node 11 timeouts	<i>Real</i>	0...4294967295	-	1 = 1
208.22	Node 12 timeouts	<i>Real</i>	0...4294967295	-	1 = 1
208.23	Node 13 timeouts	<i>Real</i>	0...4294967295	-	1 = 1
208.24	Node 14 timeouts	<i>Real</i>	0...4294967295	-	1 = 1
208.25	Node 15 timeouts	<i>Real</i>	0...4294967295	-	1 = 1
208.26	Node 16 timeouts	<i>Real</i>	0...4294967295	-	1 = 1
208.80	Reset diagnostics counters	<i>List</i>	0...1	-	1 = 1
209 I/O bus fan identification					
209.01	Node 1 fan 1 pulse freq	<i>Real</i>	0.0...5000.0	Hz	10 = 1 Hz
209.02	Node 1 fan 2 pulse freq	<i>Real</i>	0.0...5000.0	Hz	10 = 1 Hz
209.03	Node 1 fan 3 pulse freq	<i>Real</i>	0.0...5000.0	Hz	10 = 1 Hz
209.04	Node 1 fan 4 pulse freq	<i>Real</i>	0.0...5000.0	Hz	10 = 1 Hz
209.05	Node 2 fan 1 pulse freq	<i>Real</i>	0.0...5000.0	Hz	10 = 1 Hz
209.06	Node 2 fan 2 pulse freq	<i>Real</i>	0.0...5000.0	Hz	10 = 1 Hz
209.07	Node 2 fan 3 pulse freq	<i>Real</i>	0.0...5000.0	Hz	10 = 1 Hz
209.08	Node 2 fan 4 pulse freq	<i>Real</i>	0.0...5000.0	Hz	10 = 1 Hz
209.09	Node 3 fan 1 pulse freq	<i>Real</i>	0.0...5000.0	Hz	10 = 1 Hz
209.10	Node 3 fan 2 pulse freq	<i>Real</i>	0.0...5000.0	Hz	10 = 1 Hz
209.11	Node 3 fan 3 pulse freq	<i>Real</i>	0.0...5000.0	Hz	10 = 1 Hz
209.12	Node 3 fan 4 pulse freq	<i>Real</i>	0.0...5000.0	Hz	10 = 1 Hz
209.13	Node 4 fan 1 pulse freq	<i>Real</i>	0.0...5000.0	Hz	10 = 1 Hz
209.14	Node 4 fan 2 pulse freq	<i>Real</i>	0.0...5000.0	Hz	10 = 1 Hz
209.15	Node 4 fan 3 pulse freq	<i>Real</i>	0.0...5000.0	Hz	10 = 1 Hz
209.16	Node 4 fan 4 pulse freq	<i>Real</i>	0.0...5000.0	Hz	10 = 1 Hz
209.17	Node 5 fan 1 pulse freq	<i>Real</i>	0.0...5000.0	Hz	10 = 1 Hz
209.18	Node 5 fan 2 pulse freq	<i>Real</i>	0.0...5000.0	Hz	10 = 1 Hz
209.19	Node 5 fan 3 pulse freq	<i>Real</i>	0.0...5000.0	Hz	10 = 1 Hz
209.20	Node 5 fan 4 pulse freq	<i>Real</i>	0.0...5000.0	Hz	10 = 1 Hz
209.21	Node 6 fan 1 pulse freq	<i>Real</i>	0.0...5000.0	Hz	10 = 1 Hz
209.22	Node 6 fan 2 pulse freq	<i>Real</i>	0.0...5000.0	Hz	10 = 1 Hz
209.23	Node 6 fan 3 pulse freq	<i>Real</i>	0.0...5000.0	Hz	10 = 1 Hz
209.24	Node 6 fan 4 pulse freq	<i>Real</i>	0.0...5000.0	Hz	10 = 1 Hz
209.25	Node 7 fan 1 pulse freq	<i>Real</i>	0.0...5000.0	Hz	10 = 1 Hz
209.26	Node 7 fan 2 pulse freq	<i>Real</i>	0.0...5000.0	Hz	10 = 1 Hz
209.27	Node 7 fan 3 pulse freq	<i>Real</i>	0.0...5000.0	Hz	10 = 1 Hz
209.28	Node 7 fan 4 pulse freq	<i>Real</i>	0.0...5000.0	Hz	10 = 1 Hz
209.29	Node 8 fan 1 pulse freq	<i>Real</i>	0.0...5000.0	Hz	10 = 1 Hz
209.30	Node 8 fan 2 pulse freq	<i>Real</i>	0.0...5000.0	Hz	10 = 1 Hz
209.31	Node 8 fan 3 pulse freq	<i>Real</i>	0.0...5000.0	Hz	10 = 1 Hz
209.32	Node 8 fan 4 pulse freq	<i>Real</i>	0.0...5000.0	Hz	10 = 1 Hz
209.33	Node 9 fan 1 pulse freq	<i>Real</i>	0.0...5000.0	Hz	10 = 1 Hz
209.34	Node 9 fan 2 pulse freq	<i>Real</i>	0.0...5000.0	Hz	10 = 1 Hz
209.35	Node 9 fan 3 pulse freq	<i>Real</i>	0.0...5000.0	Hz	10 = 1 Hz
209.36	Node 9 fan 4 pulse freq	<i>Real</i>	0.0...5000.0	Hz	10 = 1 Hz
209.37	Node 10 fan 1 pulse freq	<i>Real</i>	0.0...5000.0	Hz	10 = 1 Hz
209.38	Node 10 fan 2 pulse freq	<i>Real</i>	0.0...5000.0	Hz	10 = 1 Hz
209.39	Node 10 fan 3 pulse freq	<i>Real</i>	0.0...5000.0	Hz	10 = 1 Hz
209.40	Node 10 fan 4 pulse freq	<i>Real</i>	0.0...5000.0	Hz	10 = 1 Hz
209.41	Node 11 fan 1 pulse freq	<i>Real</i>	0.0...5000.0	Hz	10 = 1 Hz

No.	Name	Type	Range	Unit	FbEq32
209.42	Node 11 fan 2 pulse freq	<i>Real</i>	0.0...5000.0	Hz	10 = 1 Hz
209.43	Node 11 fan 3 pulse freq	<i>Real</i>	0.0...5000.0	Hz	10 = 1 Hz
209.44	Node 11 fan 4 pulse freq	<i>Real</i>	0.0...5000.0	Hz	10 = 1 Hz
209.45	Node 12 fan 1 pulse freq	<i>Real</i>	0.0...5000.0	Hz	10 = 1 Hz
209.46	Node 12 fan 2 pulse freq	<i>Real</i>	0.0...5000.0	Hz	10 = 1 Hz
209.47	Node 12 fan 3 pulse freq	<i>Real</i>	0.0...5000.0	Hz	10 = 1 Hz
209.48	Node 12 fan 4 pulse freq	<i>Real</i>	0.0...5000.0	Hz	10 = 1 Hz
209.49	Node 13 fan 1 pulse freq	<i>Real</i>	0.0...5000.0	Hz	10 = 1 Hz
209.50	Node 13 fan 2 pulse freq	<i>Real</i>	0.0...5000.0	Hz	10 = 1 Hz
209.51	Node 13 fan 3 pulse freq	<i>Real</i>	0.0...5000.0	Hz	10 = 1 Hz
209.52	Node 13 fan 4 pulse freq	<i>Real</i>	0.0...5000.0	Hz	10 = 1 Hz
209.53	Node 14 fan 1 pulse freq	<i>Real</i>	0.0...5000.0	Hz	10 = 1 Hz
209.54	Node 14 fan 2 pulse freq	<i>Real</i>	0.0...5000.0	Hz	10 = 1 Hz
209.55	Node 14 fan 3 pulse freq	<i>Real</i>	0.0...5000.0	Hz	10 = 1 Hz
209.56	Node 14 fan 4 pulse freq	<i>Real</i>	0.0...5000.0	Hz	10 = 1 Hz
209.57	Node 15 fan 1 pulse freq	<i>Real</i>	0.0...5000.0	Hz	10 = 1 Hz
209.58	Node 15 fan 2 pulse freq	<i>Real</i>	0.0...5000.0	Hz	10 = 1 Hz
209.59	Node 15 fan 3 pulse freq	<i>Real</i>	0.0...5000.0	Hz	10 = 1 Hz
209.60	Node 15 fan 4 pulse freq	<i>Real</i>	0.0...5000.0	Hz	10 = 1 Hz
209.61	Node 16 fan 1 pulse freq	<i>Real</i>	0.0...5000.0	Hz	10 = 1 Hz
209.62	Node 16 fan 2 pulse freq	<i>Real</i>	0.0...5000.0	Hz	10 = 1 Hz
209.63	Node 16 fan 3 pulse freq	<i>Real</i>	0.0...5000.0	Hz	10 = 1 Hz
209.64	Node 16 fan 4 pulse freq	<i>Real</i>	0.0...5000.0	Hz	10 = 1 Hz

10

Fault tracing

Contents of this chapter

The chapter lists the warning and fault messages including possible causes and corrective actions. It also contains descriptions for the LEDs of the CIO-01 module.

Safety



WARNING! Only qualified electricians are allowed to service the supply unit. See *Safety instructions for ACS880 multidrive cabinets and modules* (3AUA0000102301 [English]) for air-cooled modules, and *Safety instructions for ACS880 liquid-cooled multidrive cabinets and modules* (3AXD50000048633 [English]) for liquid-cooled modules.

Warning and fault indications

A warning or fault message on the panel display or on Drive composer PC tool indicates abnormal drive status. Most warning and fault causes can be identified and corrected using the information in this chapter. If not, contact ABB representative.

Warning messages

Code (hex)	Warning	Cause	What to do
AE90	I/O bus communication	Communication break noticed on I/O bus.	Check I/O bus wiring, powering of the nodes and node number settings on the CIO-01 module. Parameters of parameter group 208 I/O bus diagnostics can be used to identify the nodes that are timing out.
AE91	Fan lifetime exceeded	Warning limit for fan lifetime (parameter 206.08) has been exceeded.	See the auxiliary code for indication of module IDs that contain fans that have exceeded their lifespan. Auxiliary code is a bit word where bit 0 indicates CIO-01 module assigned to node ID 1. Replace the failing fan and reset the fan data via parameter group 207 I/O bus service .
AE92	Fan speed	Fan speed is under limit (parameter 206.06).	Check fan feedback. See parameters 206.30...206.33 for individual failing fans.
AE93	Fan speed feedback error	Error in fan speed feedback.	See the auxiliary code for node(s) giving faulty feedback indication for fan(s). Auxiliary code is a bit word where bit 0 indicates CIO-01 module assigned to node ID 1. Check fan feedback. Verify the identification run results against the tachometer pulse count of the fan feedback.
AE94	CIO MCB monitoring	Warning related to miniature circuit breaker. Some of the bits of the MCB status word are 0.	Check miniature circuit breaker and digital input DI5.
AE95	CIO fuse monitoring	Warning related to fuses. Some of the bits of the fuse status word are 0.	Check fuses and digital input DI6.
AE97	CIO DI8 monitoring	Warning related to digital input DI8.	Check digital input DI8.

Fault messages

Code (hex)	Fault	Cause	What to do
8E12	Fan speed	Fan speed is under limit (parameter 206.07).	Check fan feedback. See parameters 206.30...206.33 for individual failing fans.
8E13	I/O module version mismatch	Communication services of the CIO-01 module are incompatible with the firmware version on the control unit.	See the auxiliary code for incompatible CIO-01 module. Auxiliary code is a bit word where bit 0 indicates CIO-01 module assigned to node ID 1. Replace the incompatible CIO-01 module.
8E14	CIO MCB monitoring	Fault related to miniature circuit breaker. Some of the bits of the MCB status word are 0.	Check miniature circuit breaker and digital input DI5.
8E15	CIO fuse monitoring	Fault related to fuses. Some of the bits of the fuse status word are 0.	Check fuses and digital input DI6.
8E17	CIO DI8 monitoring	Fault related to digital input DI8.	Check digital input DI8.

LEDs of the CIO-01 module

LED	Color	Description
MODULE	Green	Normal operation
	Red	System fault. Replace the CIO-01 module.
	Orange (ie. green and red)	Configuration change is pending: node address has been changed recently for the CIO-01 module, but the control program has not yet acknowledged the change.
NETWORK	Blinking green	Data transmission is ongoing on the RS-485 communication link: CIO-01 module received a message and generated a reply.
	Red	No communication on the RS-485 communication link: communication timeout has been exceeded.
PWR	Green	The module is powered (24 V supply).
DO1...DO4	Green	DO status for each channel. Lit when output is high.
DI1...DI8	Green	DI status for each channel. Lit when output is sinking current.

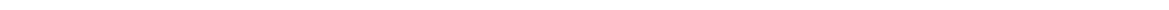

11

Technical data

Contents of this chapter

This chapter contains the technical data of the CIO-01 module.

Specifications

Input voltage	24 V (-15%/+20%)
Maximum input current	1 A
Current consumption	100 mA (typical)
RS-485	
• power supply	5 V (±5%), 100 mA
• communication data rate	< 200 kbps
Digital outputs (DO)	
• power supply	15 V (±5%), 20 mA
• modulation frequency	< 2 kHz
• maximum sinking current	100 mA
Digital inputs (DI)	
• power supply	15 V (±5%), 100 mA
• input frequency	4× < 2 kHz, 4× < 100 Hz
• input impedance	1250 ohm
Analog inputs (AI)	
Input impedance	> 1 kohm
Analog voltage measurement range	0...5.0 V
NTC measurement (Not in use.)	
• supply voltage	5 V (±5%)
• nominal NTC value (25 °C)	10 kohm
• accuracy	1%
• B value	3975

Ambient conditions

Storage temperature	-40 °C...+85 °C (-40...185 °F))
Operating temperature	+0 to +70 °C (32...158 °F)
Maximum relative humidity	90% (non condensing)
Maximum operating altitude	5000 m (16404 ft)

Protection class

IP20

Materials

Housing	Hot-dip zinc coated steel, cover painted
Package	Cardboard

Applicable standards

See *Electrical planning instructions for ACS880 liquid-cooled multidrive cabinets and modules* (3AXD50000048634 [English]).

Further information

Product and service inquiries

Address any inquiries about the product to your local ABB representative, quoting the type designation and serial number of the unit in question. A listing of ABB sales, support and service contacts can be found by navigating to abb.com/searchchannels.

Product training

For information on ABB product training, navigate to new.abb.com/service/training.

Providing feedback on ABB Drives manuals

Your comments on our manuals are welcome. Navigate to new.abb.com/drives/manuals-feedback-form.

Document library on the Internet

You can find manuals and other product documents in PDF format on the Internet at abb.com/drives/documents.



abb.com/drives