



# 1768 CompactLogix Power Supplies

Catalog Numbers 1768-PA3, 1768-PB3

<b>Topic</b>	<b>Page</b>
Important User Information	2
About the 1768 Power Supplies	5
Safety Circuits	11
Main Power Disconnect	12
Install the Power Supply	16
Mount the Power Supply	16
Place 1769 I/O Modules in a 1768 CompactLogix System	22
Interpret the LED Indicators	23
Specifications	27
Additional Resources	31

## About This Publication

Use this publication to install the 1768-PA3 and 1768-PB3 CompactLogix power supplies.

## Important User Information

Solid state equipment has operational characteristics differing from those of electromechanical equipment. Safety Guidelines for the Application, Installation and Maintenance of Solid State Controls (publication SGI-1.1 available from your local Rockwell Automation sales office or online at <http://literature.rockwellautomation.com>) describes some important differences between solid state equipment and hard-wired electromechanical devices. Because of this difference, and also because of the wide variety of uses for solid state equipment, all persons responsible for applying this equipment must satisfy themselves that each intended application of this equipment is acceptable.





In no event will Rockwell Automation, Inc. be responsible or liable for indirect or consequential damages resulting from the use or application of this equipment.

The examples and diagrams in this manual are included solely for illustrative purposes. Because of the many variables and requirements associated with any particular installation, Rockwell Automation, Inc. cannot assume responsibility or liability for actual use based on the examples and diagrams.

No patent liability is assumed by Rockwell Automation, Inc. with respect to use of information, circuits, equipment, or software described in this manual.

Reproduction of the contents of this manual, in whole or in part, without written permission of Rockwell Automation, Inc., is prohibited.

Throughout this manual, when necessary, we use notes to make you aware of safety considerations.

<p><b>WARNING</b></p> 	<p>Identifies information about practices or circumstances that can cause an explosion in a hazardous environment, which may lead to personal injury or death, property damage, or economic loss.</p>
<p><b>IMPORTANT</b></p>	<p>Identifies information that is critical for successful application and understanding of the product.</p>
<p><b>ATTENTION</b></p> 	<p>Identifies information about practices or circumstances that can lead to personal injury or death, property damage, or economic loss. Attentions help you to identify a hazard, avoid a hazard, and recognize the consequences.</p>
<p><b>SHOCK HAZARD</b></p> 	<p>Labels may be located on or inside the equipment, for example, a drive or motor, to alert people that dangerous voltage may be present.</p>
<p><b>BURN HAZARD</b></p> 	<p>Labels may be located on or inside the equipment, for example, a drive or motor, to alert people that surfaces may be dangerous temperatures.</p>

## North American Hazardous Location Approval

The following Information applies when operating this equipment in hazardous locations:	Informations sur l'utilisation de cet équipement en environnements dangereux:
<p>Products marked "CL I, DIV 2, GP A, B, C, D" are suitable for use in Class I Division 2 Groups A, B, C, D, Hazardous Locations and nonhazardous locations only. Each product is supplied with markings on the rating nameplate indicating the hazardous location temperature code. When combining products within a system, the most adverse temperature code (lowest "T" number) may be used to help determine the overall temperature code of the system. Combinations of equipment in your system are subject to investigation by the local Authority Having Jurisdiction at the time of installation.</p>	<p>Les produits marqués "CL I, DIV 2, GP A, B, C, D" ne conviennent qu'à une utilisation en environnements de Classe I Division 2 Groupes A, B, C, D dangereux et non dangereux. Chaque produit est livré avec des marquages sur sa plaque d'identification qui indiquent le code de température pour les environnements dangereux. Lorsque plusieurs produits sont combinés dans un système, le code de température le plus défavorable (code de température le plus faible) peut être utilisé pour déterminer le code de température global du système. Les combinaisons d'équipements dans le système sont sujettes à inspection par les autorités locales qualifiées au moment de l'installation.</p>

<p><b>WARNING</b></p> 	<p><b>EXPLOSION HAZARD</b></p> <p>Do not disconnect equipment unless power has been removed or the area is known to be nonhazardous.</p> <p>Do not disconnect connections to this equipment unless power has been removed or the area is known to be nonhazardous. Secure any external connections that mate to this equipment by using screws, sliding latches, threaded connectors, or other means provided with this product.</p> <p>Substitution of components may impair suitability for Class I, Division 2.</p> <p>If this product contains batteries, they must only be changed in an area known to be nonhazardous.</p>		<p><b>RISQUE D'EXPLOSION</b></p> <p>Couper le courant ou s'assurer que l'environnement est classé non dangereux avant de débrancher l'équipement.</p> <p>Couper le courant ou s'assurer que l'environnement est classé non dangereux avant de débrancher les connecteurs. Fixer tous les connecteurs externes reliés à cet équipement à l'aide de vis, loquets coulissants, connecteurs filetés ou autres moyens fournis avec ce produit.</p> <p>La substitution de composants peut rendre cet équipement inadapté à une utilisation en environnement de Classe I, Division 2.</p> <p>S'assurer que l'environnement est classé non dangereux avant de changer les piles.</p>
---	--	--	--

## Environment and Enclosure

---

### ATTENTION



This equipment is intended for use in a Pollution Degree 2 industrial environment, in overvoltage Category II applications (as defined in IEC publication 60664-1), at altitudes up to 2000 meters (1.24 mi) without derating.

This equipment is considered Group 1, Class A industrial equipment according to IEC/CISPR Publication 11. Without appropriate precautions, there may be potential difficulties ensuring electromagnetic compatibility in other environments due to conducted as well as radiated disturbance.

This equipment is supplied as open-type equipment. It must be mounted within an enclosure that is suitably designed for those specific environmental conditions that will be present and appropriately designed to prevent personal injury resulting from accessibility to live parts. The enclosure must have suitable flame-retardant properties to prevent or minimize the spread of flame, complying with a flame spread rating of 5VA, V2, V1, V0 (or equivalent) if non-metallic. The interior of the enclosure must be accessible only by the use of a tool. Subsequent sections of this publication may contain additional information regarding specific enclosure type ratings that are required to comply with certain product safety certifications.

Besides this publication, see:

Industrial Automation Wiring and Grounding Guidelines, Allen-Bradley publication 1770-4.1.

NEMA Standards publication 250 and IEC publication 60529, as applicable, for explanations of the degrees of protection provided by different types of enclosure.

---

## Prevent Electrostatic Discharge

### ATTENTION



This equipment is sensitive to electrostatic discharge, which can cause internal damage and affect normal operation. Follow these guidelines when you handle this equipment:

- Touch a grounded object to discharge potential static.
- Wear an approved grounding wriststrap.
- Do not touch connectors or pins on component boards.
- Do not touch circuit components inside the equipment.
- Use a static-safe workstation, if available.
- Store the equipment in appropriate static-safe packaging when not in use.

## About the 1768 Power Supplies

The CompactLogix power supply provides power through the CompactLogix backplane. The backplane is built into the 1768 and 1769 power supplies, controllers, and I/O modules.

In addition to backplane power, both the 1768-PA3 and 1768-PB3 power supplies offer a 24V dc external power supply terminal.

### 1768-PA3 Power Supply

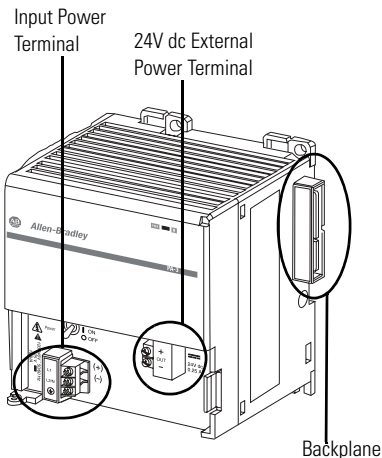

### 1768-PB3 Power Supply

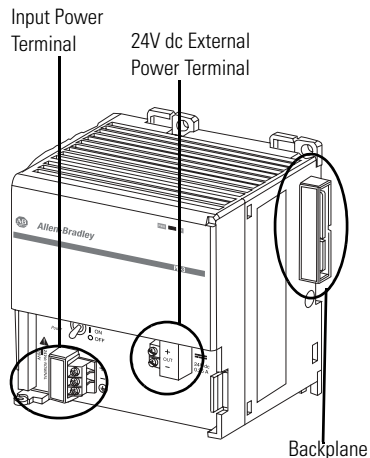

### 1768-PA3 Power Supply

The 1768-PA3 power supply is a dual-input power supply that operates in multiple ranges. The 1768-PA3 offers the following input power supply options:

- 85...265V ac
- 108...132V dc

### 1768-PB3 Power Supply

The 1768-PB3 power supply is a single-input power supply. The 1768-PB3 offers the following input power supply range:

- 16.8...31.2V dc

### About the Power Supplies in a CompactLogix System

The CompactLogix system is set up differently than other Logix systems. The following are considerations specific to the CompactLogix system:

#### 1768 CompactLogix System

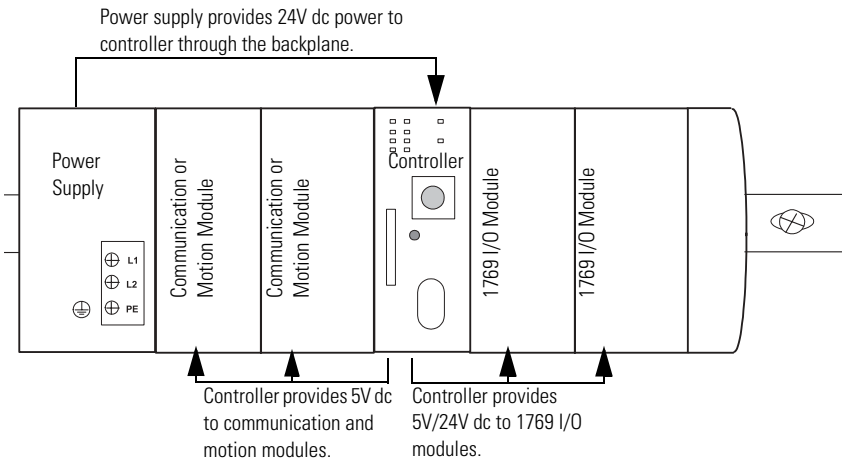

- Both the 1768-PA3 and the 1768-PB3 power supplies require that a 1768 CompactLogix controller be installed in the same bank as the power supply before the system is powered.

The power supply sends 24V dc to the controller located either immediately to the right of the power supply or immediately to the right of the communication and motion modules.

The controller converts the 24V dc to 5V dc and distributes 5V dc and 24V dc power as required by modules on the backplane. The following list describes controller power distribution considerations:

- 5V/24V power goes to 1769 I/O modules on the right side of the controller.
- 5V power goes to 1768 communication or motion modules on the left side of the controller.
- System power-up and power-down may take longer than expected.
- Full power-up should occur within a few seconds of turning on the power supply. Power-down, however, takes significantly longer. When the power supply is turned off, the CompactLogix controller uses some power to write its program to internal memory. During this program write, there is activity on the controller's status indicators.

---

**IMPORTANT**

When you turn the CompactLogix power supply off, make sure you wait for all status indicators on the power supply and controller to turn off before disconnecting any part from the system.

If you disconnect the CompactLogix system while the controller is still writing its program to memory, the program write will not be completed and you will lose your program.

---

- If your system is not receiving power, the cause may or may not be the power supply.

For example, if a 5V short exists in the 1769 I/O portion of the local chassis, the controller faults and stops powering the 1769 I/O until the short condition is corrected. In this case, the power supply is operating normally and continuing to send 24V dc to the controller.

To troubleshoot any power supply issues, see Interpret the LED Indicators.

- 1769 CompactLogix I/O modules in the local chassis receive power from the 1768 power supply. However, banks of 1769 I/O modules remote to the 1768 power supply require that a 1769 power supply be installed in the remote bank.

---

**IMPORTANT**

Never install a 1769 power supply on the local 1768 CompactLogix backplane.

---

- The 1768 power supply has a different distance rating than the 1769 power supply. For more information, see Place 1769 I/O Modules in a 1768 CompactLogix System.

## Use a Fuse with the Power Supply

The CompactLogix power supply has an internal, non-replaceable fuse soldered in place. This fuse is intended to guard against fire hazard due to short circuit conditions. We recommend you put a user-replaceable fuse in line between incoming power and the power supply terminal block.

## User Power Overcurrent Condition

In the event of an overcurrent condition, the power supply outputs latch off and remain off until the overcurrent is removed and the power is cycled. Reload the your program following a power supply shutdown.

---

### ATTENTION



To avoid unexpected operation due to 24V dc user-power shutdown, monitor the 24V dc user output with a 24V dc input channel.

---



## 1768-PA3 Power Dissipation and Requirements

The following tables show power dissipation and input power requirements of the 1768-PA3 power supply.

### 1768-PA3 Power Dissipation

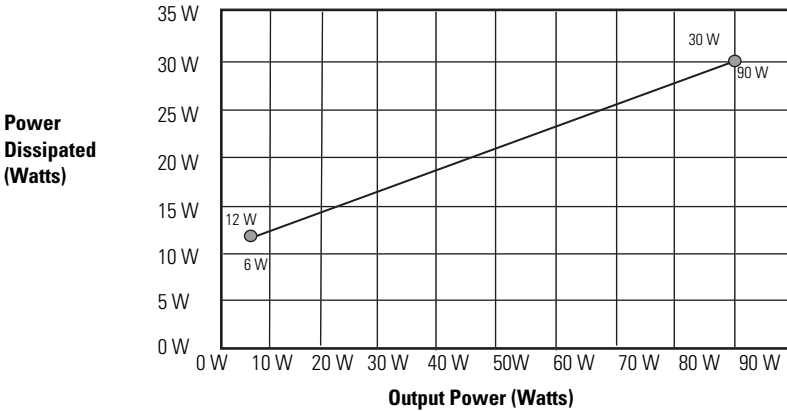

### 1768-PA3 Input Power Requirements

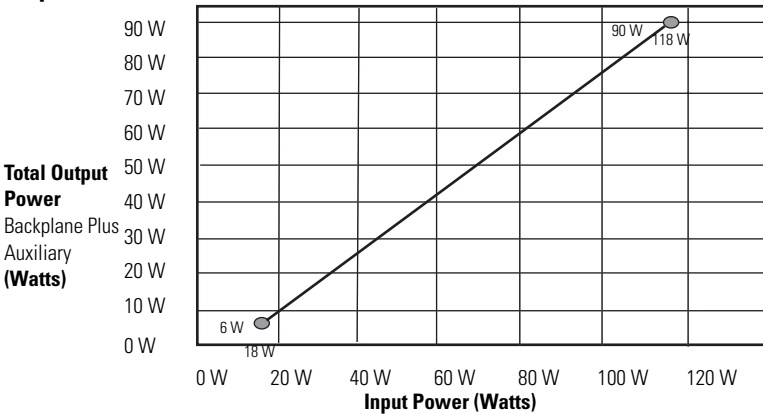

## 1768-PB3 Power Dissipation and Requirements

The following tables show power dissipation and input power requirements of the 1768-PB3 power supply.

### 1768-PB3 Power Dissipation

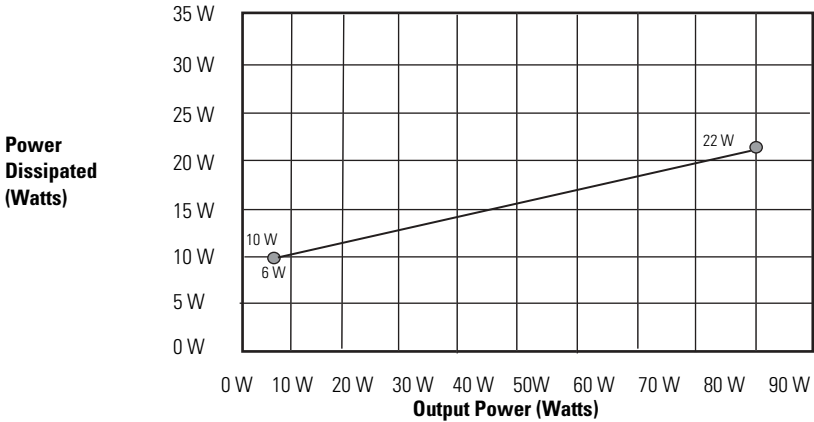

### 1768-PB3 Input Power Requirements

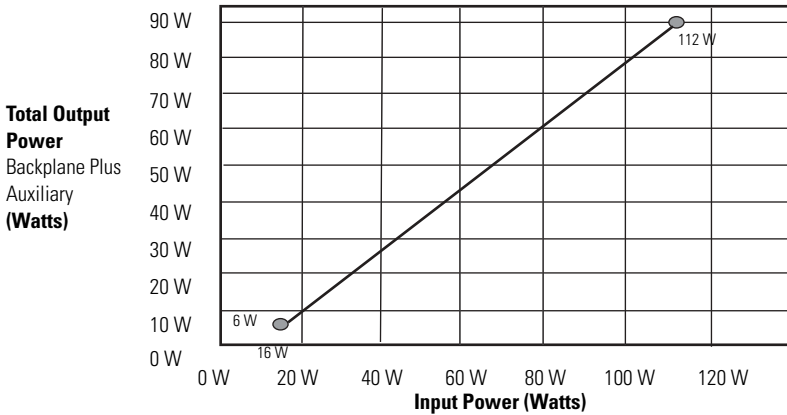

## Safety Circuits

---

### WARNING



Explosion Hazard - Do not connect or disconnect connectors while circuit is live.

---

---

### ATTENTION



Circuits installed on the machine for safety reasons, like overtravel limit switches, stop push buttons, and interlocks, should always be hard-wired directly to the master control relay. These devices must be wired in series so that when any one device opens, the master control relay is de-energized, thereby removing power to the machine. Never alter these circuits to defeat their function. Serious injury or machine damage could result.

---

---

## Power Considerations

This section describes power considerations you should take into account for the CompactLogix I/O system.

### Power Distribution

The master control relay must be able to inhibit all machine motion by removing power to the machine I/O devices when the relay is de-energized. We recommend that the controller remain powered even when the master control relay is de-energized.

Avoid the delay of power supply shut-down by wiring the master control relay to remove power from the devices instead of the 1768 power supply. Power the dc power supply directly from the fused secondary of the transformer. Connect power to the dc input and output circuits through a set of master control relay contacts.

## Main Power Disconnect

---

### WARNING



Explosion Hazard - Do not replace components or disconnect equipment unless power has been switched off.

---

Place the main power disconnect switch where operators and maintenance personnel have quick and easy access to it. In addition to disconnecting electrical power, de-energize all other sources of power (pneumatic and hydraulic) before working on a machine or process controlled by a controller.

## Isolation Transformers

We recommend that you use an isolation transformer in the ac line. This type of transformer provides isolation from your power distribution system to reduce electrical noise and is often used as a step-down transformer to reduce line voltage. Any transformer used with the Compact I/O system must have a sufficient power rating for its load. The power rating is expressed in volt-amperes (VA).

## Power Supply Inrush

During power-up, the power supply allows a brief inrush current to charge internal capacitors. Many power lines and control transformers can supply inrush current for a brief time. If the power source cannot supply this inrush current, the source voltage may sag momentarily.

The only effect of limited inrush current and voltage sag on the system is that the power supply capacitors charge more slowly. However, the effect of a voltage sag on other equipment should be considered. For example, a deep voltage sag may reset a computer connected to the same power source.

Additional considerations determine whether the power source must be required to supply high inrush current.

- The power-up sequence of devices in a system
- The amount of the power-source voltage sag if the inrush current cannot be supplied
- The effect of voltage sag on other equipment in the system

If the entire system is powered-up at the same time, a brief sag in the power source voltage typically does not affect equipment.

### *Loss of Power Source*

The power supply is designed to withstand brief power losses without affecting the operation of the system. The time the system is fully operational during power loss is called the ride-through time. The duration of the ride-through time depends on the type and state of the I/O but is typically 25 ms for the 1768-PA3 power supply and 5 ms for the 1768-PB3 power supply. At the end of the ride-through, the power supply's PWR LED status indicator toggles to indicate the end of the ride-through time.

If the power supply remains without power at the end of the ride-through time, another period of time, the hold-up time, begins. During the hold-up time, the power supply continues to partially power the system. The hold-up time is typically 5 ms for both power supplies.

When the duration of power loss extends beyond the hold-up time, the power supply can no longer provide adequate dc power. At this point, the power supply must shut down and the system performs an orderly shutdown of the controller. During the orderly shutdown of the controller, a time period called the extended hold-up time occurs. The extended hold-up time lasts from 8 to 12 seconds. During this time, the power supply provides power only to the controller. The I/O, communication, and motion modules will not receive power.

## **Input States on Power Down**

The power supply hold-up time as described above is generally longer than the turn-on and turn-off times of the inputs. The input-state of the controller changes from on to off when power is removed. The controller may then record the state before the power supply shuts down the system. This concept is important and should be taken into account when writing the program.

## Other Types of Line Conditions

Occasionally the power source to the system can be temporarily interrupted. Also, it is possible that the voltage level may drop substantially below the normal line-voltage range for a period of time. Both the interruption and the voltage sag are considered power losses for the system.

## Master Control Relay

A hard-wired master control relay (MCR) provides a reliable means for emergency machine shutdown. Since the master control relay allows the placement of several emergency-stop switches in different locations, its installation is important from a safety standpoint. Overtravel limit switches or mushroom-head push buttons are wired in series so that when any of them opens, the master control relay is de-energized. Wiring this way removes power to input and output device circuits.

---

### ATTENTION



Never alter these circuits to defeat their function since serious injury and/or machine damage could result.

---

- If you are using an external dc power supply, interrupt the dc output side rather than the ac line side of the supply to avoid the additional delay of power supply turn-off.
- The input line of the dc output power supply should be connected to an external fuse.
- Connect a set of master control relays in series with the dc power supplying the input and output circuits.

Place the main power disconnect switch where operators and maintenance personnel have quick and easy access to it. If you mount a disconnect switch inside the enclosure, place the switch operating handle on the outside of the enclosure, so that you can disconnect power without opening the enclosure.

When any of the emergency-stop switches are opened, remove power to input and output devices.

When you use the master control relay to remove power from the external I/O circuits, power continues to be provided to the system's power supply so that diagnostic indicators on the processor can still be observed.

The master control relay is not a substitute for a disconnect to the system. It is intended for any situation where the operator must quickly de-energize only I/O devices. When inspecting or installing terminal connections, replacing output fuses, or working on equipment within the enclosure, use the disconnect to shut off power to the rest of the system.

Do not control the master control relay with the Compact I/O system. Provide the operator with the safety of a direct connection between an emergency-stop switch and the master control relay.

### *Periodic Tests of Master-Control Relay Circuit*

Periodically test switches to assure they stop machine motion when needed. Any part can fail, including the switches in a master-control relay circuit. The failure of one of these switches would most likely cause an open circuit, which would be a safe power-off failure. However, if one of these switches shorts out, it no longer provides any safety protection.

## **Before You Begin**

Before you begin the installation of the 1768 power supply, consider the following:

---

### **WARNING**



Make sure power is disconnected from the power supply before removing or inserting this power supply from the 1768 CompactLogix system. When you remove or insert a power supply with power applied, an electrical arc may occur. An electrical arc can cause personal injury or property damage by:

- sending an erroneous signal to your system's field devices, causing unintended machine motion.
- causing an explosion in a hazardous environment.

Electrical arcing causes excessive wear to contacts on both the power supply and its mating connector. Worn contacts may create electrical resistance.

---

## Install the Power Supply

To install the power supply, you must complete multiple tasks.

- Mount the Power Supply
- Wire the Power Supply
- Place 1769 I/O Modules in a 1768 CompactLogix System

The 1768 CompactLogix power supply distributes power from the right side of the supply and must be the leftmost module in the system. The maximum amount of current the system supports on the backplane is 3.5 A at 24V dc. The maximum amount of current the system supports externally is 0.25 A at 24V dc.

## Mount the Power Supply

Before you mount the power supply, make sure you have proper spacing and cooling.

### ATTENTION



During panel or DIN rail mounting of all devices, be sure that all debris, for example, metal chips or wire strands, is kept from falling into the module. Debris that falls into the module could cause damage on power-up.

Maintain spacing from enclosure walls, wireways, and adjacent equipment. For adequate ventilation allow:

- 90 mm (3.54 in.) of space to the left of the power supply.
- 90 mm (3.54 in.) of space to the right of last module in the bank.
- 105 mm (4 in.) of space on the top and bottom of the bank.

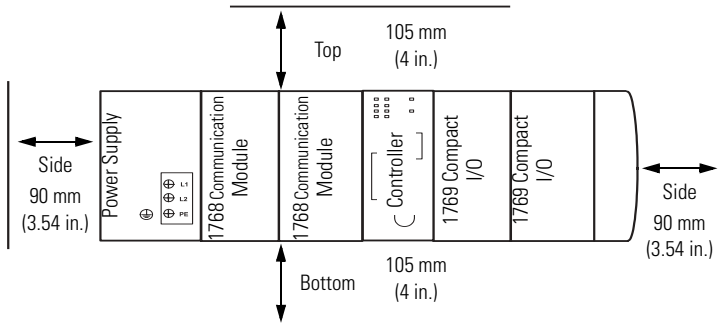

44024



### *Prevent Excessive Heat*

Convective cooling keeps the system temperature within the specified operating range. Make sure that the specified temperature range is maintained. Proper spacing of components within an enclosure is usually sufficient for heat dissipation.

Do not bring in unfiltered outside air. Place the CompactLogix system in an enclosure to protect it from a corrosive atmosphere. Harmful contaminants or dirt could cause improper operation or damage to components. In extreme cases, you may need to use air conditioning to protect against heat build-up within the enclosure.

### *Mount the Power Supply to a Panel*

Mount the power supply to a panel by using four screws per module. Use M4 or #8 panhead screws through the anchors on the corners of the power supply. Mounting screws are required on each power supply panel mounting tab.

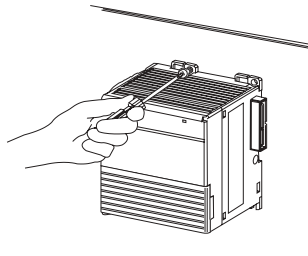

1. Drill pilot holes in your panel.
2. Insert and tighten M4 or #8 screws through the holes in the anchors.  
Tighten screws using 1.16 Nm (10 lb-in) torque.
3. If you panel-mount the entire system, connect the modules and close all DIN rail latches in the system.  
Closing the DIN rail latches locks the modules together.

### *Mount the Power Supply to a DIN Rail*

**ATTENTION**



This product is grounded through the DIN rail to chassis ground. Use zinc-plated yellow-chromate steel DIN rail to assure proper grounding. The use of other DIN rail materials (for example, aluminum and plastic) that can corrode, oxidize, or are poor conductors, can result in improper or intermittent grounding. Secure DIN rail to mounting surface approximately every 200 mm (7.87 in.) and use end-anchors appropriately.

---

The power supply can be mounted using the following DIN rails:

- 35 x 7.5 mm (EN 50 022 - 35 x 7.5)
- 35 x 15 mm (EN 50 022 - 35 x 15)

1. Close the DIN rail latches.
2. Press the DIN rail mounting area of the power supply against the DIN rail.

The latches will momentarily open and close, locking into place.

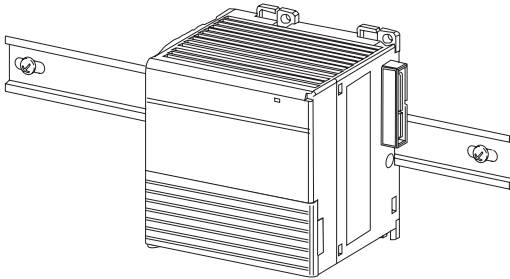

The DIN rail mount of the power supply is now complete.

## Wire the Power Supply

### WARNING



If you connect or disconnect wiring while the field-side power is on, an electrical arc can occur. This could cause an explosion in hazardous location installations. Be sure that power is removed or the area is nonhazardous before proceeding.

Use the following instructions to wire the input terminal of your power supply (required) and to wire the output terminal of your power supply (optional).

### Wire the Input Power Terminal

Use #14 AWG 75 °C (167 °F) copper wire to connect input power. Use the graphic to connect incoming power to the input power-supply terminal block.

#### 1768-PA3 Terminal

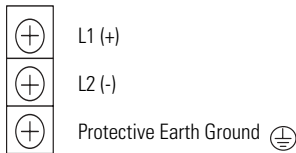

#### 1768-PB3 Terminal

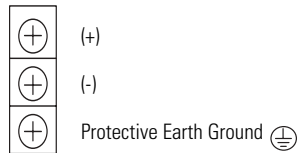

1. Turn the screw counterclockwise to open the terminal.
2. Insert the bare wire into the terminal.
3. Turn the screw clockwise to tighten the terminal on the wire.

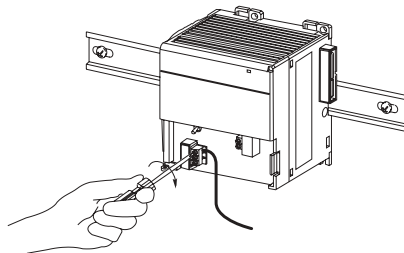

## Ground the Power Supply

### ATTENTION



This product is grounded through the DIN rail to chassis ground. Use zinc-plated yellow-chromate steel DIN rail to assure proper grounding. The use of other DIN rail materials, for example, aluminum or plastic, that can corrode, oxidize, or are poor conductors, can result in improper or intermittent grounding. Secure DIN rail to mounting surface approximately every 200 mm (7.87 in.) and use end-anchors appropriately.

Ground the power supply on a ground bus with a dedicated earth-ground stake. The ground bus should also be connected to a functional earth ground on the DIN rail or panel. The upper left tab on the power supply serves as a functional ground.

### Ground Wiring

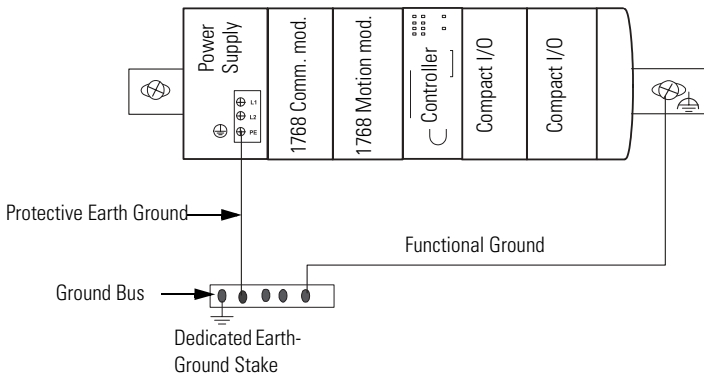

Refer to Industrial Automation Wiring and Grounding Guidelines, Allen-Bradley publication 1770-4.1, for additional information.

### Wire the Ground

Complete the following steps to wire the protective-earth ground:

1. Locate the protective-earth ground terminal, indicated by the following symbol.



2. Turn the screw counterclockwise to open the terminal.

3. Insert the bare wire into the terminal.
4. Turn the screw clockwise to tighten the terminal on the wire.

This symbol  $\oplus$  denotes a protective earth-ground that provides a low impedance path between electrical circuits and earth for safety purposes and provides noise immunity improvement. This connection must be made for safety purposes.

## Wire the Optional Output Power Terminal

Use #14...22 AWG 75 °C (167 °F) copper wire to connect the 24V dc external power source.

Connect power to the power supply terminal block according to the graphic.



1. Turn the screw counterclockwise to open the terminal.
2. Insert the bare wire into the terminal.
3. Turn the screw clockwise to tighten the terminal on the wire.

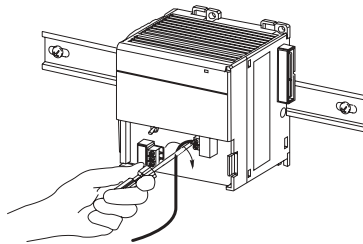

## Place 1769 I/O Modules in a 1768 CompactLogix System

You can use up to eight 1769 I/O modules in the same bank as the 1768 power supply. 1769 I/O modules must be placed to the right of the controller. Additional 1769 I/O modules may be placed in remote 1769 banks.

### 1768 System with 1769 Modules

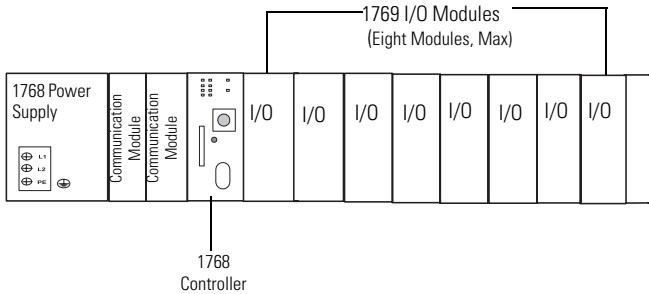

---

#### **IMPORTANT**

Because the 1768 CompactLogix power supply works with the controller to power a 1768 system, the distance rating in a 1768 CompactLogix system is different than in a 1769 CompactLogix system.

In the 1768 system, the distance rating is the distance between 1769 I/O modules and the controller. In the 1769 system, the distance rating is the distance between 1769 I/O modules and the power supply.

---

For more information on placing I/O modules in the 1768 CompactLogix system, see the 1768 CompactLogix Controller User Manual, publication 1768-UM001.

## Interpret the LED Indicators

The CompactLogix power supply works with the CompactLogix controller to provide power to the system. Because the power supply and controller are each required, you must consider both when attempting to troubleshoot a power issue in your system.

### IMPORTANT

In multiple instances throughout this section, we recommend that you disconnect, reconnect, or replace components in the 1768 CompactLogix system. Before you disconnect, reconnect, or replace any component, make sure you have turned off power and allowed all system status indicators to turn off.

To troubleshoot any system power issues, use the CompactLogix power supply PWR status indicator and the CompactLogix controller PWR and I/O PWR status indicators. You should troubleshoot the power supply and controller status indicators in a specific order.

1. Troubleshoot the power supply PWR status indicator.

If the power supply is not operating properly, the controller will not be operating properly either. You must first diagnose and correct any issues with the power supply before troubleshooting the controller.

### LED Indicators

If the power supply PWR status indicator is	It means	Take this action
Off	One of the following:	
	The supply is turned off or it does not have adequate input power.	Verify that the power supply is turned on and that adequate input power is properly connected.
	A short/overload condition exists in the 1768 system.	Isolate the power supply so that it is disconnected from all parts of the system and apply power. If the indicator remains off, verify adequate input power or consider replacing the power supply.
	The supply needs to be replaced.	Replace the power supply.
Green	The power supply is operating properly.	No action necessary for the power supply. Check the controller PWR and I/O PWR status indicators to make sure the entire system is operating properly.

If the power supply PWR status indicator is	It means	Take this action
Red	The power supply cannot produce valid 24V power to the 1768 modules.	<p>A. Disconnect all modules from the system.</p> <p>B. Reapply power.</p> <p>C. Check the PWR status indicator.</p> <ul style="list-style-type: none"> <li>• If the status indicator remains red, replace the power supply.</li> <li>• If the status indicator is green, one of the other modules in the system is causing the red indicator. Move to the next step.</li> </ul> <p>D. Reinstall any 1768 motion or communication modules.</p> <p>E. Reapply power.</p> <ul style="list-style-type: none"> <li>• If the status indicator is green, either the 1768 controller or one of the 1769 I/O modules is causing the red indicator.</li> <li>• If the status indicator remains red, one of the 1768 communication or motion modules is causing the red indicator. Move to the next step.</li> </ul> <p>F. Disconnect the 1768 communication or motion modules from the system one at a time.</p> <p>G. After each module is removed from the system, reapply power to the power supply and check the PWR status indicator.</p> <ul style="list-style-type: none"> <li>• If the status indicator is green, the most recently-removed 1768 module caused the red indicator and should be replaced.</li> <li>• If the status indicator remains red, continue disconnecting 1768 modules one at a time until the PWR status turns green.</li> </ul>

2. If the power supply is operating properly, troubleshoot the controller PWR indicator.

**IMPORTANT**

This step assumes the system is fully assembled and the power supply PWR status indicator is green.



<b>If the controller PWR status indicator is</b>	<b>It means</b>	<b>Take this action</b>
Off	Either the controller or the power supply is not operating properly. Most likely, in this case, the controller has an issue because the power supply PWR status indicator is green.	<p>A. Make sure all modules in the system are installed properly and fully engaged with each other.</p> <p>B. If the controller PWR status indicator remains off, move to the next step.</p> <p>C. Remove any 1768 communication or motion modules.</p> <p>D. Reinstall the controller directly next to the power supply and reapply power.</p> <p>E. If the controller PWR status indicator remains off, replace the controller.</p> <p>F. If the controller PWR status indicator on the new controller remains off, replace the power supply.</p>
Green	The controller is operating properly with respect to sending power to the 1768 modules.	Check the controller I/O PWR status indicator to make sure the entire system is operating properly.
Red	<p>One of the following:</p> <ul style="list-style-type: none"> <li>• The controller needs to be replaced.</li> <li>• If 1768 communication and motion modules are installed in the system, one of the 1768 modules needs to be replaced.</li> </ul>	<p>A. Disconnect all of the 1768 communication and motion modules from the system.</p> <p>B. Reapply power.</p> <p>C. Check the controller PWR status indicator.</p> <ul style="list-style-type: none"> <li>• If the status indicator is green, the controller is operating properly and one of the other 1768 modules needs to be replaced.</li> <li>• To troubleshoot the 1768 modules, see their respective installation instructions. For a list of related publications, see Additional Resources.</li> <li>• If the status indicator remains red, replace the controller.</li> </ul>

3. If the controller PWR status indicator is green, troubleshoot the controller I/O PWR status indicator.

**IMPORTANT**

This step assumes the power supply PWR and controller PWR status indicators are green.

If the controller I/O PWR status indicator is	It means	Take this action
Off	The controller needs to be replaced.	Replace the controller.
Green	The controller is operating properly.	None
Red <sup>(1)</sup>	One of the following: <ul style="list-style-type: none"> <li>• The controller needs to be replaced.</li> <li>• If 1769 I/O modules are installed in the system, one of the modules needs to be replaced.</li> <li>• There is a 1769 power supply installed in the local I/O bank.</li> </ul>	A. If there is a 1769 power supply in the local I/O bank, remove it and reapply power.  If the I/O PWR status indicator remains red, move to the next step.  B. Disconnect the 1769 I/O modules from the system.  C. Reapply power.  D. Check the controller I/O PWR status indicator. <ul style="list-style-type: none"> <li>• If the status indicator is green, the controller is operating properly and one of the other 1769 I/O modules needs to be replaced.                               To troubleshoot the 1769 I/O modules, see their respective installation instructions.</li> <li>• If the status indicator remains red, replace the controller.</li> </ul>

<sup>(1)</sup> When the controller powers up, the I/O PWR status indicator is red momentarily and then changes to green if there are no issues. However, if the I/O PWR remains red, you should use the table to diagnose and correct any issues.

## Specifications

### 1768-PA3 and 1768-PB3, CompactLogix Power Supplies

Attribute	1768-PA3	1768-PB3
Efficiency	75% Typical	80% Typical @ 24V dc
Enclosure Type Rating	None (open-style)	None (open-style)
Input Voltage Range	85...265V ac 108...132V dc	16.8-31.2V dc
Input Frequency Range	47...63 Hz (85...265V ac)	N/A
Input Power, Max	120 VA/120 W	112 W @ 24V dc
Inrush Current, Nom	25 A @ 85...132V ac 50 A @ 195...265V ac 25 A @ 108...132V dc	30 A @ 16.8...31.2V dc <sup>(2)</sup>
Inrush Current, Max	50 A @ 85...132V ac 80 A @ 195...265V ac	50 A @ 16.8...31.2V dc <sup>(2)</sup>
North American Temp Code	T4	T5
Power Dissipation, Max	30 W	22 W @ 24V dc
Isolation Voltage	250V, Reinforced Insulation Type, input to system and 24V dc AUX, Tested at 4250V dc for 60 s 150V, Basic Insulation Type, 24V dc AUX to system, Tested at 2200V dc for 60 s	250V, Reinforced Insulation Type, input to system and 24V dc AUX, Tested at 4250V dc for 60 s 150V, Basic Insulation Type, 24V dc AUX to system, Tested at 2200V dc for 60 s
Internal Overcurrent Protection	Non-replaceable fuse is soldered in place.	
Recommended External Overcurrent Protection	4...6 A @ 28.5...36.7 A <sup>2</sup> S	8...12 A @ 166...250 A <sup>2</sup> S
Overcurrent Protection, Max	15 A, user supplied	
Wire Size, Input Power Terminal	14 AWG (2.5 mm <sup>2</sup> ) solid or stranded copper wire rated at 75 °C (167°C) or greater, 1.2 mm (3/64 in.) insulation maximum	
Wire Size, Output Power Terminal	2.5 mm <sup>2</sup> (14 AWG)... 0.25 mm <sup>2</sup> (22 AWG) solid or stranded copper wire rated at 75 °C (167 °C) or greater, 1.2 mm (3/64 in.) insulation maximum	
Wiring Category <sup>(1)</sup>	1- on power ports	
Conductor Screw Torque	0.6 Nm (5 lb-in)	
Dimensions (HxWxD), Approx.	131.25 x 132.75 x 105.50 mm (5.17 x 5.23 x 4.15 in.)	
Weight, Approx.	0.98 kg (2.15 lb)	1.01 kg (2.22 lb)
Continuous Output Power 90 W, Max	24V dc to backplane: 3.5 A 24V dc to user accessible terminal block: 0.25 A	
Continuous Output Power 6W, Min	24V dc to backplane: 0.25 A 24V dc to user accessible terminal block: 0.0 A	

**1768-PA3 and 1768-PB3, CompactLogix Power Supplies**

Attribute	1768-PA3	1768-PB3
Output #1: 24V dc to Backplane		
Ride-through Interval Time, Min	25 ms @ 90 W	5 ms @ 90 W
Full Power Hold-up Interval	5 ms @ 90 W	
Extended Hold-up Interval	8...12 s @ 1.25 W	
Output #2: 24V dc to Front Panel Terminal Block		
Voltage	18...27.60V @ front panel	
Output Disable	Disable output during hold-up periods	

(1) Use this Conductor Category information when planning conductor routing. Refer to Industrial Automation Wiring and Grounding Guidelines, publication 1770-4.1.

(2) Does not include X-capacitor charging current.

**Environmental Specifications**

Attribute	1768-PA3	1768-PB3
Conducted RF Immunity	IEC 61000-4-6 10V rms with 1 kHz sine-wave 80% AM from 150 kHz...80 MHz	
EFT/B Immunity	IEC 61000-4-4: ±4kV at 5 kHz on power ports	
Emissions	CISPR 11: Group 1, Class A	
ESD Immunity	IEC 61000-4-2: 6 kV contact discharges 8 kV air discharges	
Radiated RF Immunity	IEC 61000-4-3: <ul style="list-style-type: none"> <li>• 10V/m with 1 kHz sine-wave 80%AM from 30...2000 MHz</li> <li>• 10V/m with 200 Hz 50% Pulse 100%AM at 900 MHz</li> <li>• 10V/m with 200 Hz 50% Pulse 100%AM at 1890 MHz</li> <li>• 1V/m with 1 kHz sine-wave 80%AM from 2000...2700 MHz</li> </ul>	
Relative Humidity	IEC 60068-2-30 (Test Db, Unpackaged Damp Heat): 5...95% noncondensing	
Shock, Operating	IEC 60068-2-27 (Test Ea, Unpackaged Shock): 30 g	
Shock, Nonoperating	IEC 60068-2-27 (Test Ea, Unpackaged Shock): 50 g	

## Environmental Specifications

Attribute	1768-PA3	1768-PB3
Surge Transient Immunity	IEC 61000-4-5: <ul style="list-style-type: none"> <li>• <math>\pm 2</math> kV line-line (DM) and <math>\pm 4</math> kV line-earth (CM) on ac power ports</li> <li>• <math>\pm 1</math> kV line-line (DM) and <math>\pm 2</math> kV line-earth (CM) on dc power ports</li> </ul>	IEC 61000-4-5: <ul style="list-style-type: none"> <li>• <math>\pm 1</math> kV line-line (DM) and <math>\pm 2</math> kV line-earth (CM) on dc power ports</li> </ul>
Temperature, Operating	IEC 60068-2-1 (Test Ad, Operating Cold) IEC 60068-2-2 (Test Bd, Operating Dry Heat) IEC 60068-2-14 (Test Nb, Operating Thermal Shock): 0...60 °C (32...140 °F)	
Temperature, Storage	IEC 60068-2-1 (Test Ab, Unpackaged Nonoperating Cold) IEC 60068-2-2 (Test Bb, Unpackaged Nonoperating Dry Heat) IEC 60068-2-14 (Test Na, Unpackaged Nonoperating Thermal Shock): -40...85 °C (-40...185 °F)	
Vibration	IEC 60068-2-6 (Test Fc, Operating): 5 g @ 10...500 Hz	
Voltage Variation	IEC 61000-4-11: <ul style="list-style-type: none"> <li>• 30% dips for 1 period at 0° &amp; 180° on ac supply ports</li> <li>• 60% dips for 5 &amp; 50 periods on ac supply ports</li> <li>• <math>\pm 10\%</math> fluctuations for 15 min on ac supply ports</li> <li>• &gt; 95% interruptions for 250 periods on ac supply ports</li> </ul>	IEC 61000-4-29: <ul style="list-style-type: none"> <li>• 60% dip for 100 ms on dc supply ports</li> <li>• 30% dip for 10 ms on dc supply ports</li> <li>• 100% dip for 10 ms on dc supply ports</li> <li>• <math>\pm 20\%</math> fluctuations for 15 min on dc supply ports</li> <li>• 5 s interruptions on dc supply ports</li> </ul>

## Certifications

The following certifications apply when the product is marked.

Certifications <sup>(1)</sup>	1768-PA3	1768-PB3
C-Tick	Australian Radio Communications Act, compliant with: AS/NZS CISPR 11; Industrial Emissions	
c-UL-us	UL Listed Industrial Control Equipment, certified for US and Canada. See UL File E65584. UL Listed for Class I, Division 2 Group A,B,C,D Hazardous Locations, certified for U.S. and Canada. See UL File E194810.	
CE Description	European Union 89/336/EEC EMC Directive, compliant with: <ul style="list-style-type: none"> <li>• EN 50082-2; Industrial Immunity</li> <li>• EN 61326; Meas./Control/Lab., Industrial Requirements</li> <li>• EN 61000-6-2; Industrial Immunity</li> <li>• EN 61000-6-4; Industrial Emissions</li> <li>• EN 61131-2; Programmable Controllers (Clause 8, Zone A &amp; B)</li> </ul> European Union 73/23/EEC LVD, compliant with: <ul style="list-style-type: none"> <li>• EN 61010-1; Meas./Control/Lab</li> </ul>	European Union 89/336/EEC EMC Directive, compliant with: <ul style="list-style-type: none"> <li>• EN 50082-2; Industrial Immunity</li> <li>• EN 61326; Meas./Control/Lab., Industrial Requirements</li> <li>• EN 61000-6-2; Industrial Immunity</li> <li>• EN 61000-6-4; Industrial Emissions</li> <li>• EN 61131-2; Programmable Controllers (Clause 8, Zone A &amp; B)</li> </ul> European Union 73/23/EEC LVD, compliant with: <ul style="list-style-type: none"> <li>• EN 61010-1; Meas./Control/Lab</li> </ul>

<sup>(1)</sup> See the Product Certification link at <http://www.ab.com> for Declarations of Conformity, Certificates, and other certification details.

## Additional Resources

Consult the following publications as sources of additional information.

<b>For</b>	<b>Refer to this document</b>	<b>Pub. No.</b>
A description of how to use your CompactLogix controller	1768 CompactLogix Controllers Installation Instructions	1768-IN004
	1768 CompactLogix Controllers User Manual	1768-UM001
A description of how to use your CompactLogix EtherNet/IP module	CompactLogix EtherNet/IP Communication Module Installation Instructions	1768-IN002
	CompactLogix EtherNet/IP Communication Module User Manual	ENET-UM001
A description of how to use your CompactLogix SERCOS interface module	CompactLogix SERCOS interface Module Installation Instructions	1768-IN005
	Motion Modules in Logix5000 Control Systems User Manual	LOGIX-UM002
A description of Compact I/O modules	Compact I/O Selection Guide	1769-SG002
More information on proper wiring and grounding techniques	Industrial Automation Wiring and Grounding Guidelines	1770-4.1

You can view or download publications at <http://literature.rockwellautomation.com>. To order paper copies of technical documentation, contact your local Rockwell Automation distributor or sales representative.

CompactLogix is a registered trademark of Rockwell Automation, Inc.

Trademarks not belonging to Rockwell Automation are property of their respective companies.

# Rockwell Automation Support

Rockwell Automation provides technical information on the Web to assist you in using its products. At <http://support.rockwellautomation.com>, you can find technical manuals, a knowledge base of FAQs, technical and application notes, sample code and links to software service packs, and a MySupport feature that you can customize to make the best use of these tools.

For an additional level of technical phone support for installation, configuration, and troubleshooting, we offer TechConnect Support programs. For more information, contact your local distributor or Rockwell Automation representative, or visit <http://support.rockwellautomation.com>.

## Installation Assistance

If you experience a problem with a hardware module within the first 24 hours of installation, please review the information that's contained in this manual. You can also contact a special Customer Support number for initial help in getting your module up and running.

United States	1.440.646.3223 Monday – Friday, 8am – 5pm EST
Outside United States	Please contact your local Rockwell Automation representative for any technical support issues.

## New Product Satisfaction Return

Rockwell tests all of its products to ensure that they are fully operational when shipped from the manufacturing facility. However, if your product is not functioning, it may need to be returned.

United States	Contact your distributor. You must provide a Customer Support case number (see phone number above to obtain one) to your distributor in order to complete the return process.
Outside United States	Please contact your local Rockwell Automation representative for return procedure.

[www.rockwellautomation.com](http://www.rockwellautomation.com)

### Power, Control and Information Solutions Headquarters

Americas: Rockwell Automation, 1201 South Second Street, Milwaukee, WI 53204-2496 USA, Tel: (1) 414.382.2000, Fax: (1) 414.382.4444  
Europe/Middle East/Africa: Rockwell Automation, Vorstlaan/Boulevard du Souverain 36, 1170 Brussels, Belgium, Tel: (32) 2 663 0600, Fax: (32) 2 663 0640  
Asia Pacific: Rockwell Automation, Level 14, Core F, Cyberport 3, 100 Cyberport Road, Hong Kong, Tel: (852) 2887 4788, Fax: (852) 2508 1846

Publication 1768-IN001B-EN-P - July 2006

PN 953014-45

Supersedes Publication 1768-IN001A-EN-P - December 2005

Copyright © 2006 Rockwell Automation, Inc. All rights reserved. Printed in the U.S.A.