

MOD 300 Enhanced with Industrial^{IT}

The Enterprise Management & Control System
for Optimizing Process & Business Operations



Reaching New Levels of Productivity

Within ABB's new family of integrated software and hardware solutions – collectively known as Industrial IT – the MOD 300 and Advant OCS with MOD 300 Software Control Systems position customers to optimize process, plant and enterprise operations. While reaping the benefits of the innovative, enhanced Industrial IT *strategy*, customers will retain both the process security and the value of their new or existing MOD 300 *system*.

MOD 300 Software enhances the real-time sharing of knowledge between related, but divergent, enterprise operations. Fully equipped with an integrated set of decision-making tools, Industrial IT enhancements make it possible for real-time information to be shared – and its value compounded – throughout an organization. The result is better and faster decisions that optimize company assets, whether people, raw material, process, or infrastructure.

Open Architecture for Seamless Integration

Industrial IT applications are designed to be used as stand-alone or integrated solutions, enabling the flexibility to implement the required functions today and the agility to add on as needs evolve. ABB's diligent use of open standards simplifies the task of interfacing with existing automation and information systems, while the proven MOD 300 progression ensures an additional layer of established investment protection.

The Evolution Continues...

Industrial IT is the latest installment on a greater than 20-year commitment that ABB has honored with its DCS users. The company's pledge of *Evolution through Enhancement* ensures that future advances in system technologies will not compromise the customer's current investments. While other vendors may talk about investment protection, ABB's proven program is truly unique in the industry. From the introduction of the MOD 300 System in 1984, through each of the evolution steps Advant OCS with MOD 300 Software in 1992, to the introduction of Industrial IT in 2000, this commitment has been maintained by providing graceful migration from one system to the next.

A Global Leader

Today, *Evolution through Enhancement* has expanded to include the latest products and services from the world's largest automation supplier; including instrumentation, analytical devices, meters, robotics, drives, motors, machines, manufacturing execution systems, and control products and systems. Backed by common Industrial IT technology and industry specific expertise, ABB's automation portfolio provides the seamless link between process and business management to deliver knowledge-based solutions.



**MOD 300
Enhanced with
Industrial IT**

today

**Advant OCS
with MOD 300
Software**

1992

**MOD 300
Distributed Control
System**

1984

evolution
through
enhancement

Two Decades of Enhancements

Making real-time business decisions to prevent or limit process upsets requires a consistent infrastructure for data, operations, configuration, and maintenance across the entire enterprise. The foundation of this consistent infrastructure is ABB's Aspect Object™ technology provided by the Aspect Integrator Platform (AIP) component. Every Industrial IT software product is based upon the AIP component. MOD 300 fully

participates in an integrated Industrial IT environment by leveraging the full power of the Aspect Object technology by employing an open, enterprisewide architecture that supports a seamless communications fabric to every level of control – from field I/O to plantwide and multi-plant systems. MOD 300's essential security and proven availability at the control level are integrated with enterprise network strategies for total enterprise communication.

MOD 300 Distributed Control System

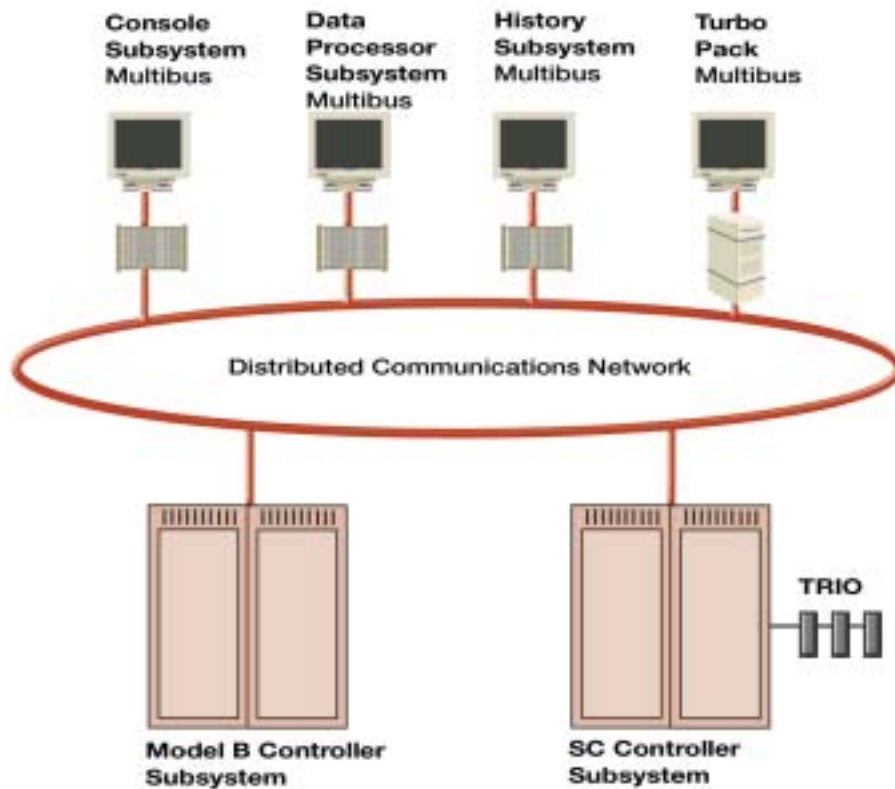

1984

Advant OCS with MOD

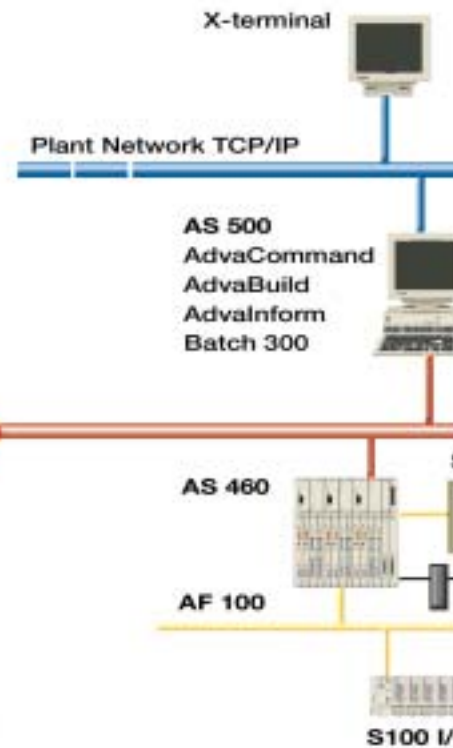

1992

The scalable MOD 300 architecture allows for easy integration of ABB Industrial IT components, such as Operate IT, Produce IT, Inform IT, and Optimize IT. In addition, non-traditional control system functional areas, such as field device management and PLC controls, simply “plug-and-produce” in the MOD 300 architecture via other ABB Industrial IT components, such as Engineer IT and Control IT.

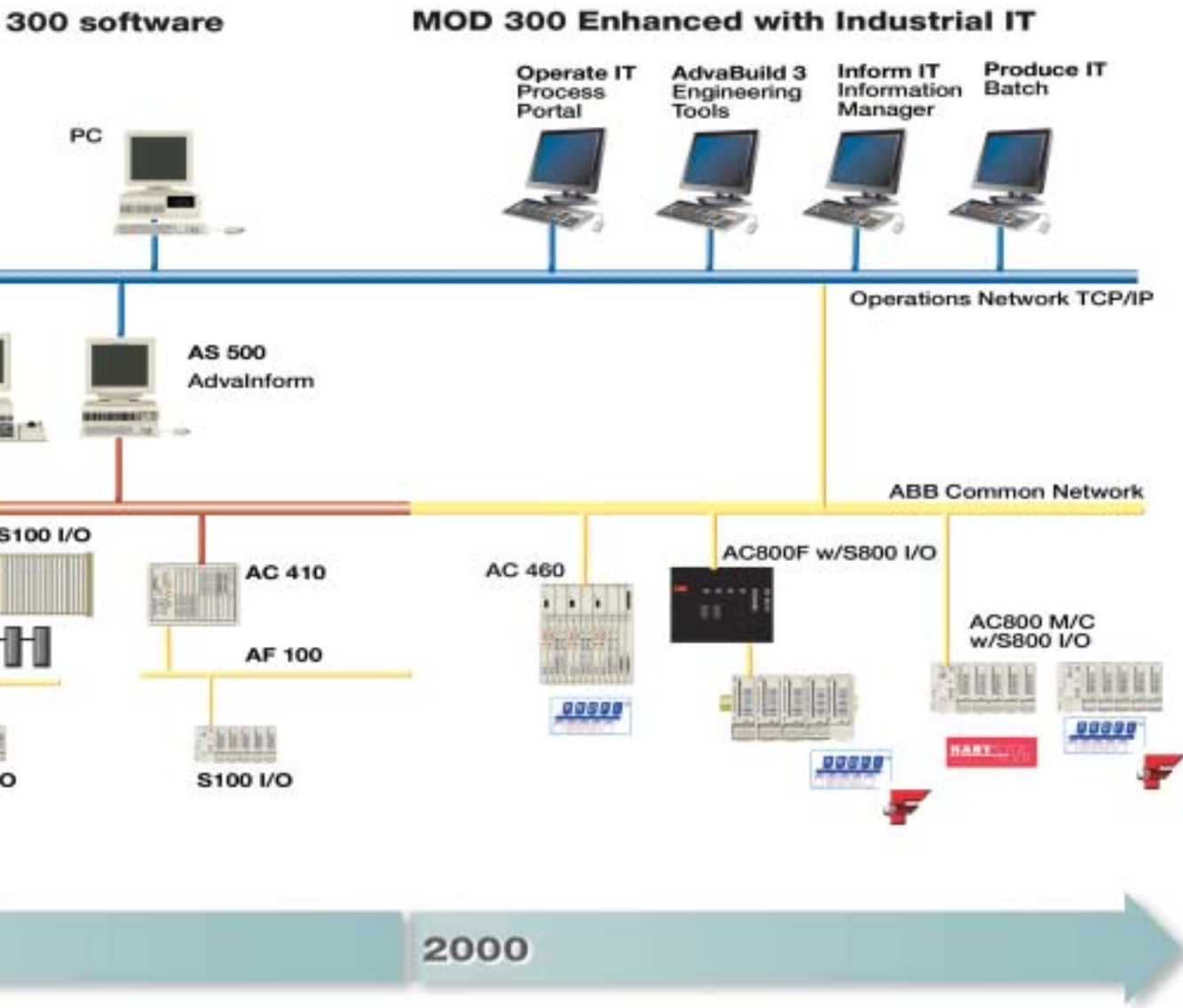

Powerful Tools

for Enterprise Management and Control

ABB's MOD 300 enhanced with Industrial IT solutions reach beyond the traditional boundaries of control systems to support the platform, application and professional service needs of total enterprise management and control.

MOD 300's span of open control provides a secure foundation with robust, but flexible, regulatory and sequence control. Solutions continue through the full range of higher level management and advanced control functions to include: production management, maintenance management, simulation, historian, and information management. The integration of these powerful features is achieved through MOD 300's integrated "Aspects" architecture.



MOD 300 enhanced with Industrial IT dramatically improves enterprisewide productivity through four powerful, integrated classes of products:

Advant Controller 460 and S800 I/O Control Products – a comprehensive set of traditional process, regulatory and sequence control services and I/O interfaces

AdvaBuild Engineering Tools – an integrated suite of engineering and maintenance tools designed to support the complete automation project, including planning and data acquisition, configuration management, library management, commissioning, and operation

Operate IT/Process Portal and AdvaCommand – a range of console products for accessing and viewing data from multiple operating environments, from process control and I/O to plant and enterprise information

Inform IT Plant Optimization and Information Management Solutions – a powerful suite of products and services for plant management and control focused on increasing asset utilization and on optimal management of plant capacity and historical data.



Operator Consoles



**Plant Optimization
& Information Management**



**Engineering, Operation
& Maintenance Tools**

Control Products

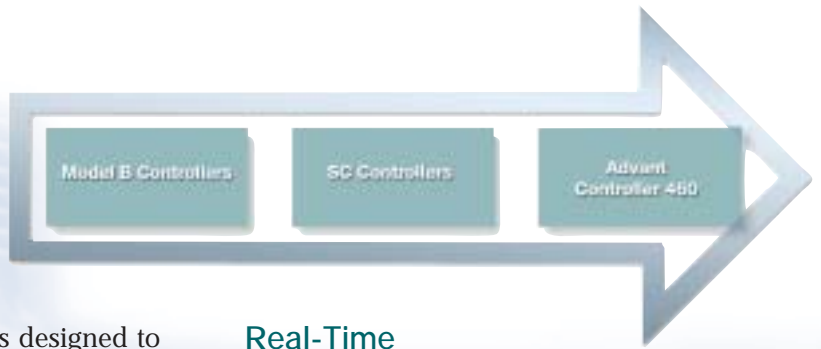

MOD 300 control software is designed to work together as an integrated system. A global database ensures that information needs to be entered only once and that multiple copies of the same information do not reside in different subsystems. Application programs such as control algorithms, operator interface, and information management all act upon one set of data.

Unlike other control systems, the user is not required to know which subsystem to access when retrieving information.

High Performance Controllers

Advant Controllers combine high processing capacity with flexible software to create a powerful control system environment. Advant Controllers benefit from the global database and three powerful control languages: CCF, TCL, and TLL. Existing Model B and SC Controllers can also co-exist on the same network and share data in a seamless manner.

The Advant Controller 460 can be configured for 1:1 redundancy and has a high-speed processor that allows many functions to execute in a single controller module.

Advant Controllers can be connected to existing Taylor Remote I/O (TRIO), S100 I/O which can be configured for redundancy, and S800 I/O a state-of-the-art modular remote I/O system.

MOD 300 Control Software

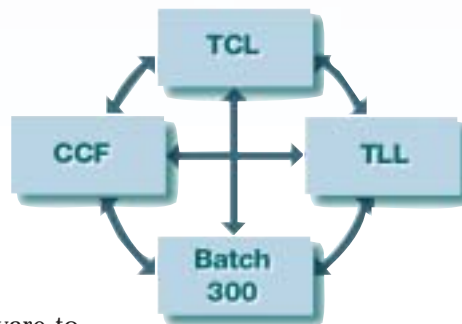

Real-Time Control Applications

MOD 300 software provides three powerful control languages. Configurable Control Functions, Taylor Control Language, and Taylor Ladder Logic provide optimal implementation approaches in the areas of continuous control, discrete device control, supervisor control, sequential and batch control, and high speed interlock logic control.

Applications developed in other MOD 300 subsystems can be executed on the Advant Controller. The ability to mix, match, and execute these control strategies simultaneously offers uncompromising versatility to meet today's processing requirements.

Configurable Control Functions (CCF) is an easy to configure, function block structured control language. It is particularly powerful in the application of continuous process control, discrete device handling and alarm detection. CCF has an extensive library of functions and is configured through a menu-driven software package using a fill-in-the-blank approach.

Taylor Control Language (TCL) is a structured high-level procedural language. The programmable flexibility of TCL is ideally suited for batch control, recipe management, batch reporting, process scheduling, supervisory control, and process start-up and shutdown.

Taylor Ladder Logic (TLL) is used for high speed process interlocking and control logic. TLL provides industry standard ladder logic control processing, reducing the need to purchase stand-alone programmable controllers.



Engineering Tools

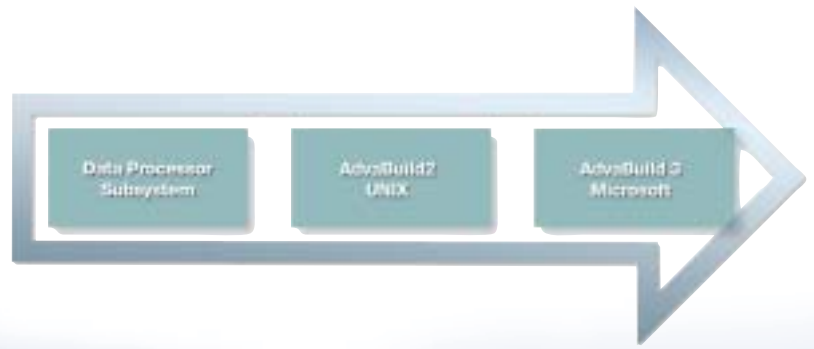

AdvaBuild Version 3 engineering tools provide you with a familiar MicroSoft based environment. AdvaBuild 3 adds openness, improves performance, reduces compile and install times, and provides a useful Journalling function.

AdvaBuild 3 supports all MOD 300 database configuration, CCF, TCL, TLL, and RDP applications such as Console Config, PageBuilder, PCConfig, and Loopfcm. MicroSoft Windows navigation and single scrollable pages with direct attribute selection and easy copy/paste - drag/drop operations provide you with greater engineering mobility. It also provides modern backup and restore capabilities.

External administrative functions are provided for project administration, load/save functions, and Journal enabling. The Control Builder includes navigator, templet and On-line Builder functions. Both the TCL and TLL Builders contain active revision control (RCS), and the TCL Builder has a new TCL Compile/Link Status feature.

The Client/Server architecture allows up to four concurrent users in the Control Builder for database development and all database changes are locked when a compile is performed.

The new Journalling feature tracks object activity and ties to revision control. All Entries are time and user stamped and Journal size is limited only by the available disk space.

Migration from your existing Multibus Data Processor or AdvaBuild UNIX software is simple, through the use of ASCII Transition Files included in AdvaBuild Version 3.

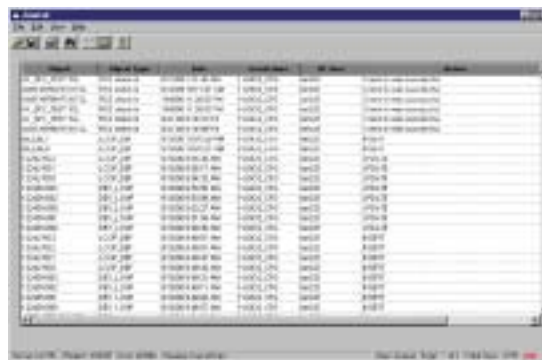

Operator Interface



AdvaCommand

AdvaCommand provides operator software that complements the inherent functionality of the control system with operator directed features and functions. These versatile features and functions are ergonomically designed to facilitate process monitoring, control, fault mitigation, and optimization. They offer more than just a way for operators to interact with machines. They provide system users with expanded dynamic access to *all* plantwide or enterprisewide information through open system connectivity.

Operate IT Process Portal

Operate IT Process Portal is a feature rich, web-enabled operator interface designed as a native Windows-based product. A managed Windows workplace within a web browser environment supports its users with intuitive navigation and compatible integration with other ABB and third party web-enabled applications, allowing users to efficiently access and monitor information flow through the control system, the process, the plant, and the entire enterprise.

Providing the versatility needed to meet ever changing operational and process needs, Process Portal supports custom navigational toolbars and user profiles for defining appropriate workspace behavior. Process Portal supports the full spectrum of plant and enterprise personnel needs including graphical user interface, process data collection, storage and analysis tools, and an advanced alarm management system. As part of an open system, Process Portal embraces OPC™ to provide a standard interface method with third party devices, and incorporates OPC client and OPC server connectivity.

Aspect Objects

Operate IT Process Portal provides all of the traditional operator functionality such as event and alarm management, and custom graphic displays. Through the use of ABB's unique Aspect Object™ technology, Process Portal provides integrated information access and sharing, intuitive navigation and efficient engineering. An Aspect Object represents a physical or logical part of the automation installation, such as a valve, pump or actual batch, but also process units or combinations of hardware units. All information, or aspects, belonging to those objects is structured in functional windows called aspect views. Examples of aspects are historical data, process signal data or technical specifications.



CAD specifications

Word documentation



Operators gain the advantage of single-click access to information-rich aspect views...

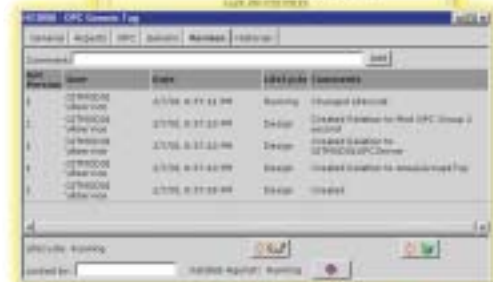
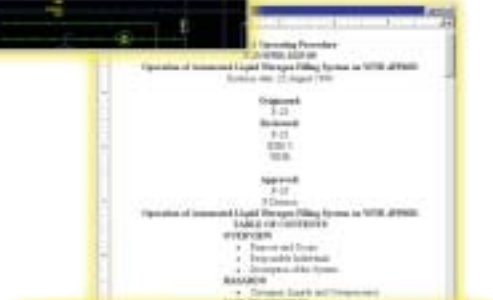

Data tags



ERP interfaces

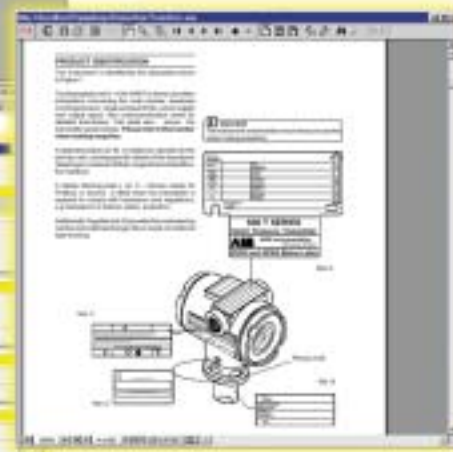

PDF technical documentation

Data Management

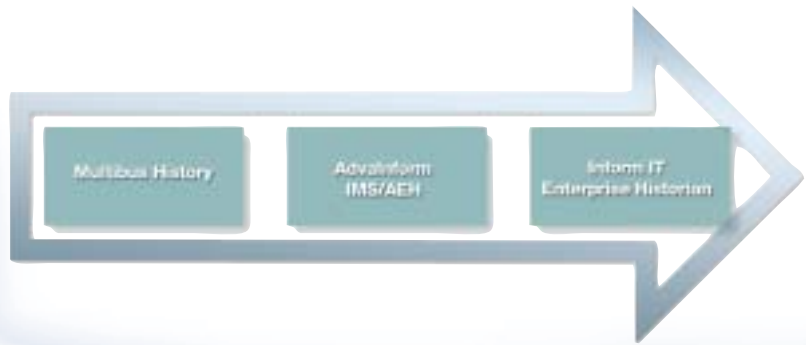

To achieve true enterprise automation, MOD 300 enhanced with Industrial IT components go beyond traditional process control to tightly integrate both control and management functions from the plant floor to the executive staff. To achieve this increased span of control, ABB offers a suite of plant management and control products, ranging from plant information management to plant optimization applications.

The new suites of plant management and control products improve enterprise productivity by:

- Providing secure, tightly integrated base regulatory and sequential controls
- Scaling advanced control across a range of technologies
- Facilitating process information propagation throughout the enterprise
- Providing for both adaptive and predictive decision support practices
- Supporting E-commerce and B2B strategies with real-time enterprise data
- Imparting protected web access when and where appropriate

Advanced Control for Increased Efficiency

Advanced control packages provide optimum production management solutions. From multi-variable control applications at the controller level to enterprise spanning Pavilion solutions, Industrial IT delivers a foundation for advanced control techniques in real-time. Backed by industry specific experience and know-how, Industrial IT advanced control applications designed to insure that plants will operate more efficiently, profitably and competitively.

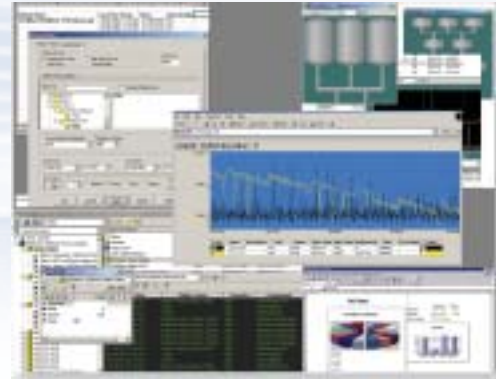

Inform IT Enterprise Historian

Information management is essential for understanding asset performance and designing procedures for optimizing assets over their life cycles.

Enterprise Historian collects, stores and retrieves historical process and business data from control and related systems, and transforms that data into meaningful information. This helps you to map out a plan to achieve significant Key Performance Indicator (KPI) improvements. Its comprehensive views of historical and process data help you to run your plant more efficiently, enabling you to make more informed production decisions.

From the project design to the implementation phase, Enterprise Historian helps you run your plant smarter and more profitably by facilitating efficient engineering, from configuration to system administration to maintenance. A single historical solution and database is used for both process control and information management, eliminating duplication of engineering effort.

Enterprise Historian offers extensive reporting and data exchange capabilities to meet a wide variety of reporting requirements. Regularly scheduled reports, as well as ad hoc reports can be generated easily in the format you specify.

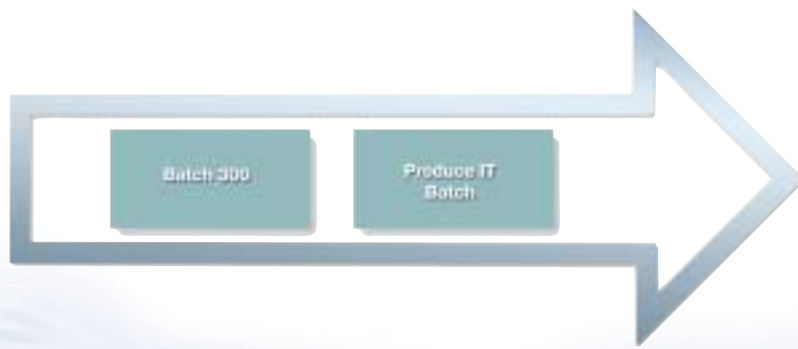

Produce IT Batch

Produce IT Batch provides batch production management solutions, delivering unsurpassed batch-to-batch consistency, quality and productivity. These measurable results are achieved through an unmatched level and scope of batch control integrated with scheduling, electronic batch records, HSI, history, and controllers. Whether a process is manual, automated or both, Produce IT offers solutions for stand-alone environments or for integrated operation with ERP, DCS, etc.

Optimize IT

Optimize IT's advanced optimization solutions address the need for real-time economic optimization in the multi-period, multi-plant enterprise.

Asset Optimization includes integration of field instruments to the control system via fieldbus protocols, maintenance triggers, interfaces with maintenance management systems, documentation management, and audit trails

Process Optimization provides the means to create and manage process models that have been optimized using a range of solutions. This allows users to address yield accounting, waste, safety, regulatory compliance, and economic issues

Dynamic Simulation and Training assists operator training and certification and aids with design validations

Supply Chain Optimization includes integrated planning, scheduling and utilization algorithms and decision tools for production of specified component quality and quantity to support E-commerce requirements

Global Support & Services

As a leading global provider of industrial asset and optimization services for power and automation systems, ABB maintains a unique position to offer innovative and diverse solutions for improved facility performance and effective maintenance systems management. With an unparalleled scope of automation products, systems and services, we provide performance-based service packages that increase production, reduce maintenance costs and improve return on existing assets.

Asset Management Services

ABB Asset Management Services move beyond a cost-cutting approach, offering customized performance-based services focused on a specific need, an entire asset classification or complete plant maintenance responsibility. Optimizing asset management through outsourcing designed to deliver improved operation and maintenance effectiveness, helps to deliver a lighter balance sheet and increased cash flow, while providing maximum value and profitability.

Asset Management Services

Consulting Services

- Plant Performance Benchmarking
- Performance Improvement Delivery
- Cultural Change Management
- Sustainable Maintenance Excellence
- Shutdown Excellence
- Safety, Health & Environmental Excellence

Total Equipment Management

- Motor Condition Monitoring
- Drive Management
- Rotating Machine Management
- Instrumentation Management
- Control Systems Management

ABB Full Service

- ABB Full Service™ Partnership Agreements
- Single Shutdown Contracts
- Multiple Shutdown Partnership Agreements

Product And System Services

A wide variety of services are available locally providing total system as well as tailored user support. From complete management services to just-in-time technical support, ABB offers unequalled services for power and automation systems. Our diverse industry and application knowledge acquired through a strong global presence can benefit your operation through improved overall performance, increased uptime and reduced costs.

Product and System Services

Customer Support Services

24x365

- Hardware/Software
- Contract & Demand
- Web, On-line & Remote Services
- Telephone Services
- Upgrades, Expansions & Modifications

Training Services

- ABB Product Training
- Process & Application Training
- General Technology Training
- Training Contracts
- Training Assessment Programs

Parts & Repair Services

- Parts Services
- Reconditioning & Repair Services
- Version Management
- Legacy Product Support
- Parts Management Support

Application Services

- Installation & Commissioning
- Product Application Services
- Product Environmental Adaptation Support
- Process Application Services
- Product Migration Services



Evolution Services

StepUp

StepUp Programs provide a cost effective means to migrate to the latest ABB products and help position your automation system for new technology as it becomes available.

This allows you to continuously evolve your system to higher levels of control, operations, information management, and connectivity.

SoftCare

The SoftCare software management program continuously provides you with immediate access to the latest productivity enabling software. In keeping your software current, SoftCare positions you for the constantly changing industry and IT standards by providing constant enhancements, better integration, and more efficient support.

Conversion Services

In development of new products, it has always been ABB's philosophy and commitment to provide an evolution path for the installed base. We continue with that commitment by providing conversion and interface services that assist in graceful migration.

These services help simplify the evolution process, reduce engineering cost, reduce installation time, and reduce risk.





For additional information,
visit us on the Internet at www.abb.com/controlsystems



ABB Inc.
29801 Euclid Avenue
Wickliffe, Ohio 44092
Phone: +1 440 585-8500
Fax: +1 440 585 8756
www.abb.com/controlsystems

ABB AB
SE-721 59 Västerås, Sweden
Phone: +46 (0) 21 34 2000
Fax: +46 (0) 21 13 78 45
www.abb.com/controlsystems

ABB GmbH
Dudenstraße 44-46, D-68167
Mannheim, Germany
Phone: +49 (0) 1805 266 776
Fax: +49 (0) 1805 776 329
www.abb.com/controlsystems

Copyright © 2003 by ABB Inc. All rights to trademarks reside with their respective owners.

Specifications subject to change without notice. Pictures, schematics and other graphics contained herein are published for illustration purposes only and do not represent product configurations or functionality. User documentation accompanying the product is the exclusive source for functionality descriptions.